



Instruction Manual

**COMPACT TYPE
GAS ANALYZER
COMMUNICATION
FUNCTIONS (MODBUS)**

TYPE: ZSV

CONTENTS

CONTENTS.....	i
1. COMMUNICATION FUNCTIONS	1
1.1 General.....	1
2. SPECIFICATIONS	2
2.1 Communication specifications.....	2
3. CONNECTION	3
3.1 Terminal allocation (Input/output terminal CN12).....	3
3.2 Connection.....	3
4. SETTING OF COMMUNICATION CONDITION	4
4.1 Set items.....	4
4.2 Setting operation.....	4
5. MODBUS COMMUNICATION PROTOCOL.....	5
5.1 General.....	5
5.2 Composition of message.....	6
5.3 Response of slave station.....	8
5.4 Function code.....	9
5.5 Calculation of error check code (CRC-16).....	10
5.6 Transmission control procedure.....	12
6. DETAILS OF MESSAGE	14
6.1 Read-out of word data [Function code:03 _H]	14
6.2 Read-out of read only word data [Function code:04 _H]	16
6.3 Write-in of word data (1 word) [Function code:06 _H].....	18
6.4 Write-in of continuous word data [Function code:10 _H].....	19
7. ADDRESS MAP AND DATA FORMAT.....	20
7.1 Data format.....	20
7.2 Address map	22
7.3 Supplement to address map	34
8. SAMPLE PROGRAM.....	35
9. TROUBLESHOOTING	39

1. COMMUNICATION FUNCTIONS

1.1 General

- This instrument provides a communication function through RS-232 interface, which allows data transmit to or receive from the host computer and other devices.
- The communication system is comprised of a master station and slave stations. One slave station (this instrument) can be connected to one master station.
It is also possible to adapt the instrument to the environment of RS-485 interface using RS-232C ↔ RS-485 converter. In this case, up to 31 of slave station (present instrument) can be connected per master station.
- Because the master station can communicate with only one slave station at a time, the destination can be identified by the "Station No" set for each slave station.
- In order that the master station and the slave station can communicate, the format of the transmit/receive data must coincide. In this instrument, the format of the communication data is determined by the MODBUS protocol.

[RS-232 ↔ RS-485 converter] (recommended article)

Type: KS-485 (non-isolated type)/SYSTEM SACOM Corp.

Type: SI-30A (isolated type)/SEKISUI ELECTRONICS Co., Ltd.

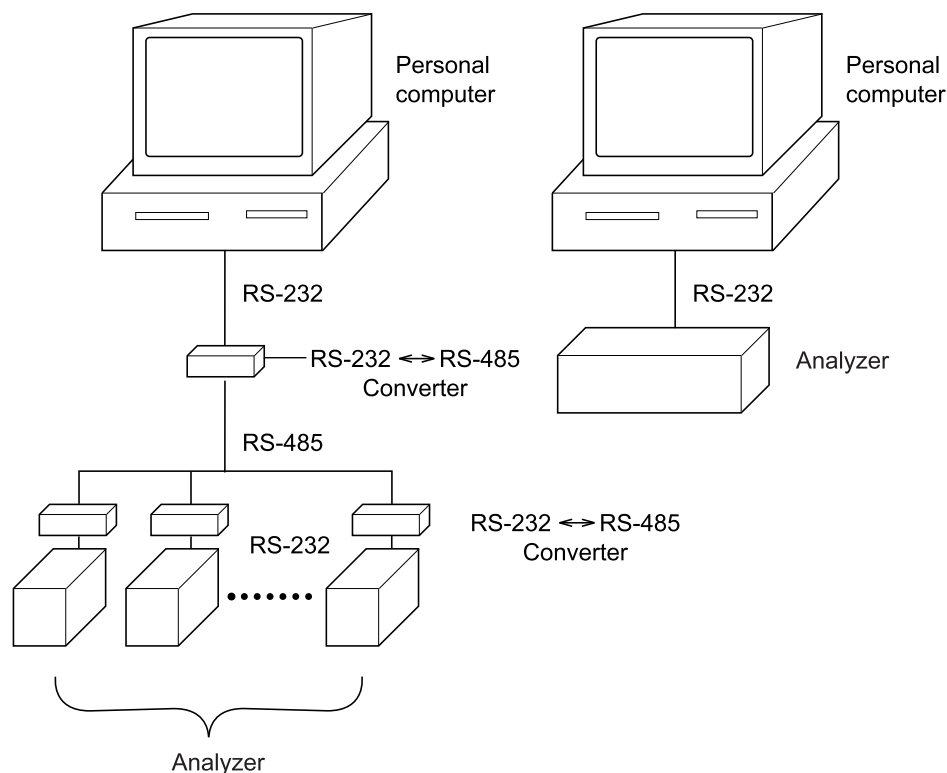

2. SPECIFICATIONS

2.1 Communication specifications

Item	Specification	
Electrical specification	Based on EIA RS-232C	
Transmission system	2-wire, semi-duplicate	
Synchronizing system	Start-stop synchronous system	
Connection format	1 : 1	
Number connectable units	1 unit (or 31 if RS-485 interface is used)	
Transmission speed	9600bps	
Data format	Data length	8 bits
	Stop bit	1 bit
	Parity	None
	X flow control	None
Transmission code	HEX value (MODBUS RTU mode)	
Error detection	CRC-16	
Isolation	No isolation between transmission circuit and others	

3. CONNECTION



WARNING

For avoiding electric shock and malfunctions, do not turn on the power supply until all wiring have been completed.

3.1 Terminal allocation (Input/output terminal CN12)

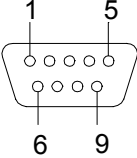
Terminal number	Signal name	Pin connection
2	Recive Data	 9-pin D-Sub (male)
3	Transmit Data	
5	Signal GND	
Others	NC	

3.2 Connection

As connecting cable, use a commercially available RS-232 reverse cable.

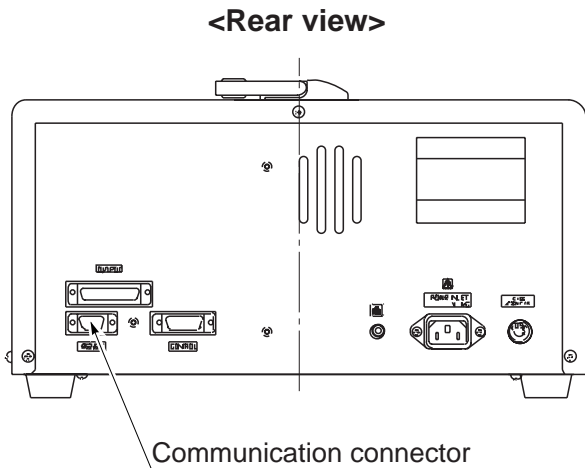
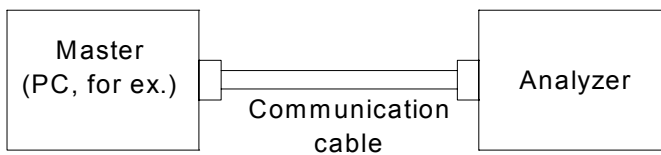

4. SETTING OF COMMUNICATION CONDITION

In order that the master station and instrument can correctly communicate, following settings are required.

- All communication condition settings of the master station are the same as those of instruments.
- All instruments connected on a line are set to "Station Nos. (STno)" which are different from each other. (Any "Station No." is not shared by more than one instrument.)

4.1 Set items

The parameters to be set are shown in the following table. Set them by operating the front panel keys.

Item	Value at delivery	Setting range	Remarks
Transmission speed	9600bps	Fixed (can not be changed)	Set the same communication condition to the master station and all slave stations.
Data length	8 bits	Fixed (can not be changed)	
Stop bit	1 bit	Fixed (can not be changed)	
Parity setting	None	Fixed (can not be changed)	
Station No.	1	0 to 31 (0: Communication function stop)	Set a different value to each station.

4.2 Setting operation

Set the station No. on the analyzer maintenance mode display (see the instruction manual).

5. MODBUS COMMUNICATION PROTOCOL

5.1 General

The communication system by the MODBUS protocol is that the communication is always started from the master station and a slave station responds to the received message.

Transmission procedures is as shown below.

- 1) The master station sends a command message to a slave station.
- 2) The slave station checks that the station No. in the received message matches with the own station No. or not.
- 3) If matched, the slave station executes the command and sends back the response message.
- 4) If mismatched, the slave station leaves the command message and wait for the next command message.

- a) In case when the station No. in the received command message matches with the own slave station No.

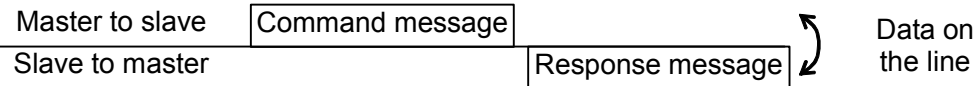

- b) In case when the station No. in the received command message mismatches with the own slave station No.

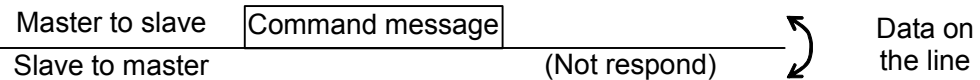

The master station can individually communicate with any one of slave stations connected on the same line upon setting the station No. in the command message.

5.2 Composition of message

Command message and response message consist of 4 fields ; Station No., Function code, Data and Error check code. And these are sent in this order.

Station No. (1 byte)
Function code (1 byte)
Data (2 to 133 bytes)
Error check code (CRC-16) (2 bytes)

Fig. 5-1 Composition of message

In the following, each field is explained.

(1) Station No.

Station No. is the number specifying a slave station. Only a slave station that corresponds to a value to which "Station No." is set on the analyzer maintenance mode display executes a command.

(2) Function code

This is a code to designate the function executed at a slave station.
For details, refer to section 5.4.

(3) Data

Data are the data required for executing function codes. The composition of data varies with function codes. For details, refer to chapter 6.

A register number is assigned to each data in the analyzer. For reading/writing the data by communication, designate the register number.

Note that the register number transmitted on message is expressed as its relative address.
The relative address is calculated by the following expression.

$$\text{Relative address} = (\text{The lower 4 digit of the } \boxed{\text{Coil number or Register number}}) - 1$$

For example, when the register number designated by a function code is 40003,

$$\begin{aligned} \text{Relative address} &= (\text{lower 4 digits of } 40003) - 1 \\ &= 0002 \end{aligned}$$

is used on the message.

(4) Error check code

This is the code to detect message errors (change in bit) in the signal transmission.

On the MODBUS protocol (RTU mode), CRC-16 (Cyclic Redundancy Check) is applied.

For CRC calculation method, refer to section 5.5.

5.3 Response of slave station

(1) Response for normal command

To a relevant message, the slave station creates and sends back a response message which corresponds to the command message. The composition of message in this case is the same as in section 5.2.

Contents of the data field depend on the function code. For details, refer to Chapter 6.

(2) Response for abnormal command

If contents of a command message have an abnormality (for example, non-actual function code is designated) other than transmission error, the slave station does not execute that command but creates and sends back a response message at error detection.

The composition of response message at error detection is as shown in Fig. 5-2. The value used for function code field is function code of command message plus 80_H.

Table 5-1 gives error codes.

Station No.
Function code + 80 _H
Error code
Error check (CRC-16)

Fig. 5-2 Response message at error detection

Table 5-1 Error code

Error code	Contents	Description
01H	Function code error	Non-actual function code is designated. Check for the function code.
02H	Address error for coil or register	A relative address that cannot be used with the specified function code is specified for the coil No. or the register No.
03H	Coil or register quantity error	Because the designation of number is too much, the area where register numbers do not exist is designated.

(3) No response

Under any of the following items, the slave station takes no action of the command message and sends back no response.

- A station number transmitted in the command message differs from the station number specified to the slave station.
- A error check code is not matched, or a transmission error (parity error, etc.) is detected.
- The time interval between the composition data of the message becomes longer than the time corresponding to 24 bits. (Refer to section 5.6 Transmission control procedure)

5.4 Function code

According to MODBUS protocol, register numbers are assigned by function codes.

Each function code acts on specific register number.

This correspondence is shown in Table 5-2, and the message length by function is shown in Table 5-3.

Table 5-2 Correspondence between function codes and objective address

Function code			Register No.	
No.	Function	Object	No.	Contents
03 _H	Read-out (continuously)	Holding register	4xxxx	Read-out/write-in word data
04 _H	Read-out (continuously)	Input register	3xxxx	Read-out word data
06 _H	Write-in	Holding register	4xxxx	Read-out/write-in word data
10 _H	Write-in (continuously)	Holding register	4xxxx	Read-out/write-in word data

Table 5-3 Function code and message length

[Unit : byte]

Function code	Contents	Number of designatable data	Command message		Response message	
			Minimum	Maximum	Minimum	Maximum
03 _H	Read-out of word data	64 words	8	8	7	133
04 _H	Read-out of word data (read-out only)	64 words	8	8	7	133
06 _H	Write-in of word data	1 word	8	8	8	8
10 _H	Write-in of continuous word data	64 words	11	137	8	8

5.5 Calculation of error check code (CRC-16)

CRC-16 is the 2-byte (16-bits) error check code. From the top of the message (station No.) to the end of the data field are calculated.

The slave station calculates the CRC of the received message, and does not respond if the calculated CRC is different from the contents of the received CRC code.

The following shows the calculation procedure for CRC-16.

- (a) Store FFFFH into 16 bit register (CRC register).
- (b) Subject the 1st byte (8 bits) of transmit message and CRC register contents to an exclusive logical summation (XOR), and store the result into the CRC register.
- (c) Shift the CRC register contents 1 bit to the right. Store 0 at MSB.
- (d) If LSB before shifting is 0, do nothing.
If LSB before shifting is 1, subject it and A001H to XOR, and store the result into the CRC register.
- (e) Repeat the steps (c) and (d) 8 times (shift by 8 bits).
- (f) Execute steps (b) to (e) for the next byte of the transmit message.
Likewise, successively repeat the steps to each byte of the transmit message.
- (g) The CRC code that is retained is the value of CRC register that stands when the processing has ended for latest byte (latest data except error code) of the transmit message.
- (h) As error check code of the transmit message, store this CRC value in the order of lower 8 bits and upper 8 bits.

Transmit message (ex.)

01 _H
06 _H
00 _H
05 _H
03 _H
E8 _H
99 _H
75 _H

Successively calculate data included here to obtain CRC. In this case, CRC = 75_H 99_H.

Attach the error check code to message upon interchanging the upper and lower orders.

Figure 5-3 on the next page shows the flow of the CRC-16 calculation system.

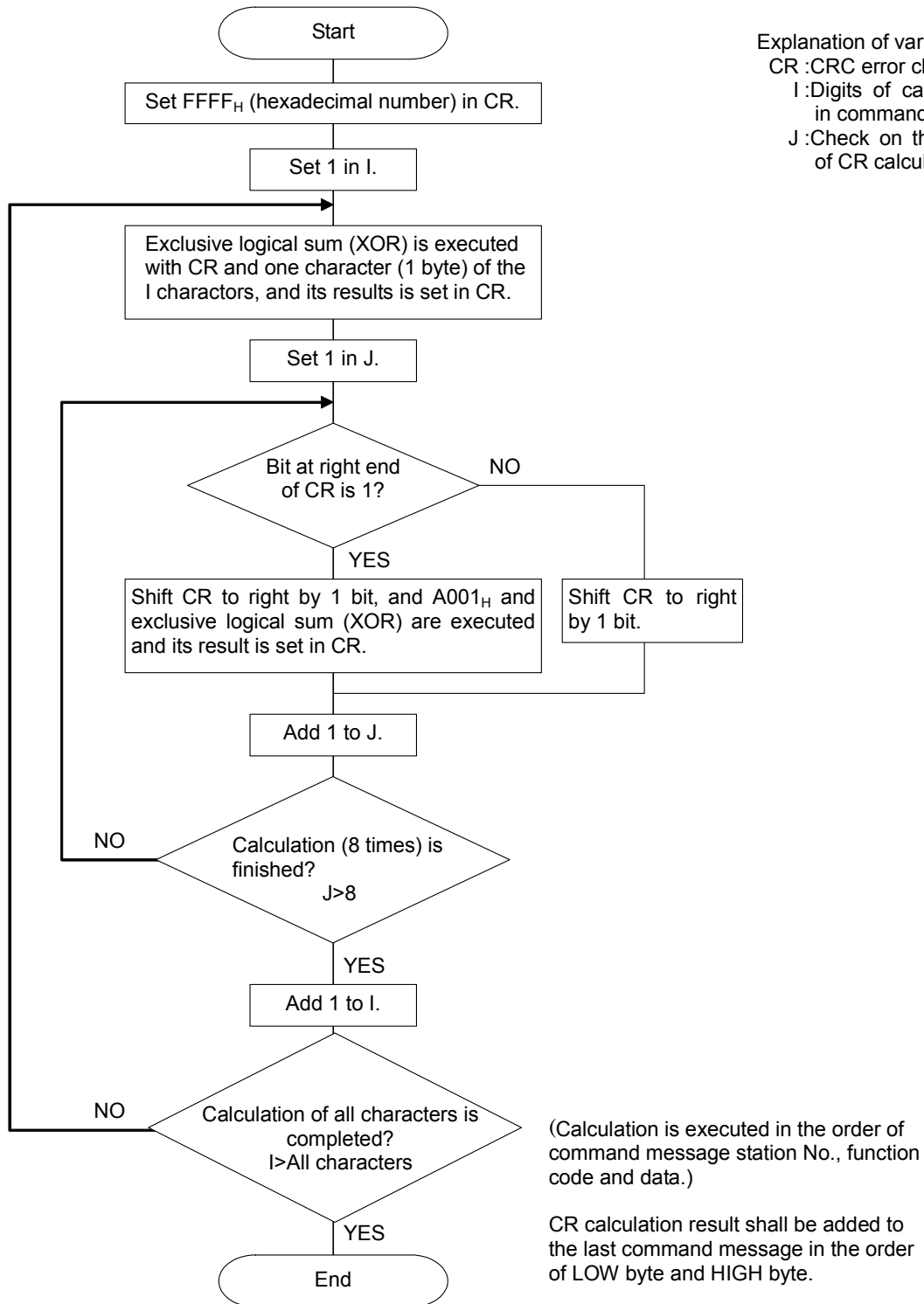

Fig. 5-3 Flow of CRC-16 calculation

5.6 Transmission control procedure

(1) Transmission procedure of master station

The master station must proceed to a communication upon conforming to the following items.

- (1-1) Before sending a command message, provide 48 bits time or more vacant status.
- (1-2) For sending, the interval between bytes of a command message is below 24 bits time.
- (1-3) Within 24 bits time after sending a command message, the receiving status is posted.
- (1-4) Provide 48 bits time or more vacant status between the end of response message reception and beginning of next command message sending [same as in (1-1)].
- (1-5) For ensuring the safety, make a confirmation of the response message and make an arrangement so as to provide 3 times or more retries in case of no response, error occurrence, etc.

Note) The values in the above definition are for marginal communications. For ensuring the safety, it's recommended the program of the master to work with safety factors of 2 to 3. Concretely, it is advised to arrange the program for 9600 bps with 10 ms or more for vacant status (1-1), and within 1 ms for byte interval (1-2) and changeover from sending to receiving (1-3).

(2) Description

1) Detection of the message frame

The status on the line of the communication system is one of the 2 below.

- (a) Vacant status (no data on line)
- (b) Communication status (data is existing)

Instruments connected on the line are initially at a receiving status and monitoring the line. When 24 bits time or more vacant status has appeared on the line, the end of preceding frame is assumed and, within following 24 bits time, a receiving status is posted. When data appears on the line, instruments receive it while 24 bits time or more vacant status is detected again, and the end of that frame is assumed. I.e., data which appeared on the line from the first 24 bits time or more vacant status to the next 24 bits time or more vacant status is fetched as one frame.

Therefore, one frame (command message) must be sent upon confirming the following.

- (1-1) 48 bits time or more vacant status precedes before the command message sending.
- (1-2) Interval between bytes of 1 command message is smaller than 24 bits time.

2) Response of this instrument

After a frame detection (24 bits time or more vacant status), this instrument carries out processing with that frame as a command message. If the command message is destined to the own station, a response message is returned. Its processing time is 1 to 30 ms (depends on contents of command message). After sending a command message, therefore, the master station must observe the following.

- (1-3) Receiving status is posted within 24 bits time after sending a command message.

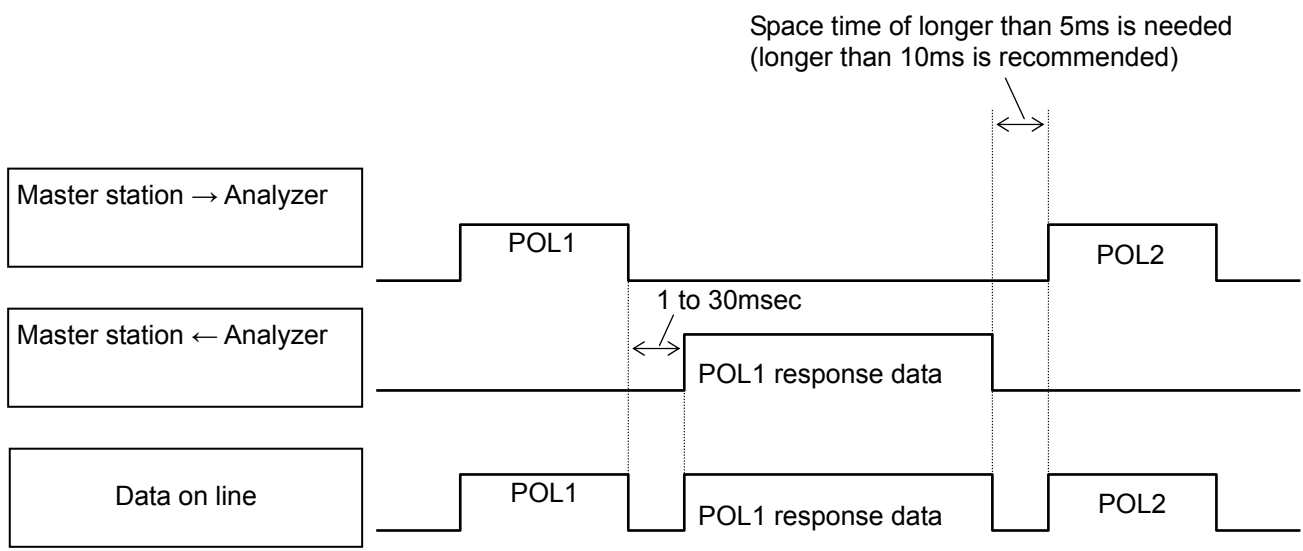

6. DETAILS OF MESSAGE

6.1 Read-out of word data [Function code:03_H]

Function code	Max. word number read-out in one message	Relative data address	Register No.
03 _H	64 words	0000 _H —004C _H	40001—40077

(1) Message composition

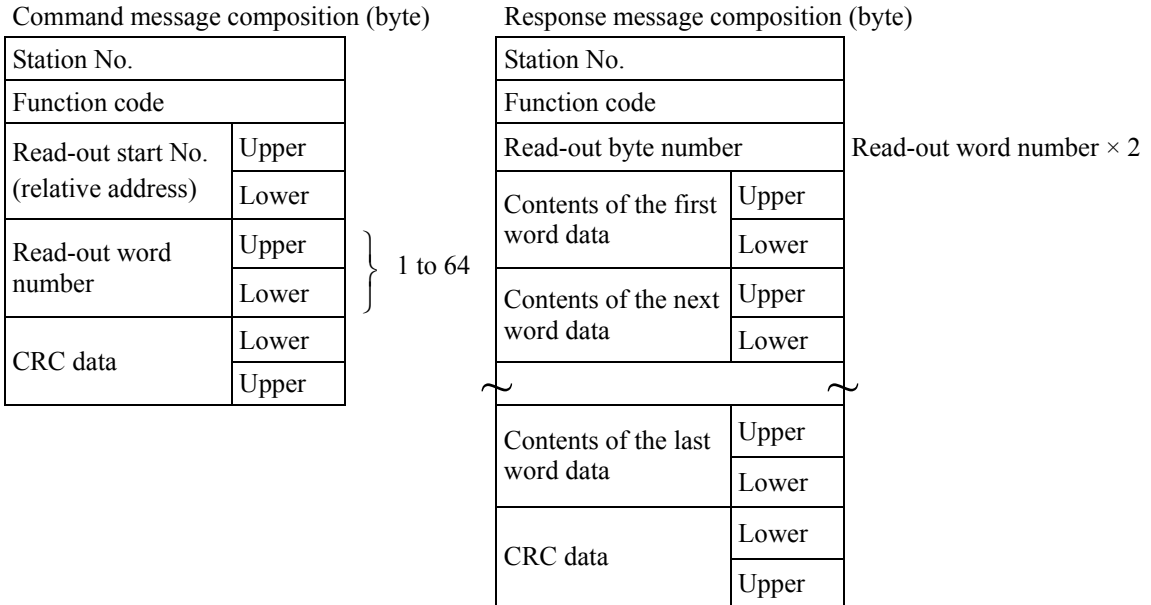

* Arrangement of read-out word data

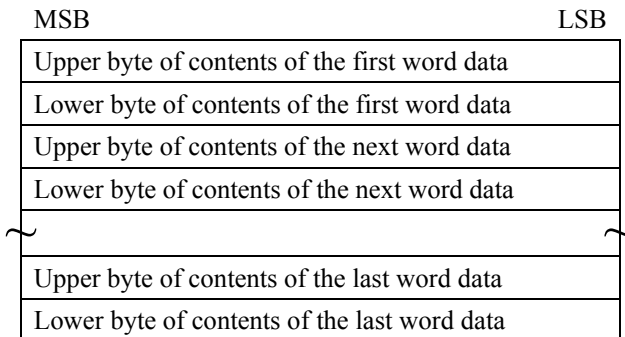

(2) Function explanations

Word data of continuous word numbers from the read-out start No. can be read. Read-out word data are transmitted from the slave station in the order of upper and lower bytes.

(3) Message transmission (example)

The following shows an example of reading out from No. 1 station the setting CH1 (1st component) range-3 zero and span calibration concentration.

Relative address of CH1 range-3 zero calibration concentration setting: 0004_H

Data number: 02_H

Command message composition (byte)

Station No.	01 _H	
Function code	03 _H	
Read-out start No. (relative address)	Upper	00 _H
	Lower	04 _H
Read-out word number	Upper	00 _H
	Lower	02 _H
CRC data	Lower	85 _H
	Upper	CA _H

Response message composition (byte)

Station No.	01 _H	
Function code	03 _H	
Read-out byte number	04 _H	
Contents of the first word data	Upper	00 _H
	Lower	00 _H
Contents of the next word data	Upper	03 _H
	Lower	E8 _H
CRC data	Lower	FA _H
	Upper	8D _H

* Meaning of read-out data

CH1 range-3 zero calibration concentration setting 00 00_H = 0
(contents of first word data)

CH1 range-3 span calibration concentration setting 03 E8_H = 1000
(contents of next word data)

Provided decimal point position = 0, measurement unit = 1,

Lower limit of concentration setting = 0 ppm

Higher limit of concentration setting = 1000 ppm

➤ **Point** ➤ For handling of decimal point and unit, refer to Section 7.1.

6.2 Read-out of read only word data [Function code:04_H]

Function code	Max. word number read-out in one message	Relative data address	Register No.	Contents
04 _H	64 words	0000 _H –00B7 _H	30001–30184	Measurement value and status
		03E8 _H –0441 _H	31001–31090	Fixed setting

(1) Message composition

Command message composition (byte)

Station No.	
Function code	
Read-out start No. (relative address)	Upper
	Lower
Read-out word number	Upper
	Lower
CRC data	Lower
	Upper

Response message composition (byte)

Station No.	
Function code	
Read-out byte number	
Contents of the first word data	Upper
	Lower
Contents of the next word data	Upper
	Lower
⋮	
Contents of the last word data	Upper
	Lower
CRC data	Lower
	Upper

Read-out word number × 2

* Arrangement of read-out word data

MSB	LSB
Upper byte of contents of the first word data	
Lower byte of contents of the first word data	
Upper byte of contents of the next word data	
Lower byte of contents of the next word data	
⋮	
Upper byte of contents of the last word data	
Lower byte of contents of the last word data	

(2) Function explanations

Word data of continuous word numbers from the read-out start No. can be read. Read-out word data are transmitted from the slave station in the order of upper and lower bytes.

(3) Message transmission (example)

The following shows an example of reading out from No. 1 station the CH5 measurement concentration, decimal point position and measurement unit.

Relative address of CH5 measurement concentration: 000C_H Data number: 03_H

Command message composition (byte)

Station No.		01 _H
Function code		04 _H
Read-out start No. (relative address)	Upper	00 _H
	Lower	0C _H
Read-out word number	Upper	00 _H
	Lower	03 _H
CRC data	Lower	70 _H
	Upper	08 _H

Response message composition (byte)

Station No.		01 _H
Function code		04 _H
Read-out byte number		06 _H
Contents of the first word data	Upper	04 _H
	Lower	B0 _H
Next word data contents	Upper	00 _H
	Lower	02 _H
Latest word data contents	Upper	00 _H
	Lower	00 _H
CRC data	Lower	81 _H
	Upper	0D _H

* Meaning of read-out data

First word data contents 04 B0_H = 1200
 Next word data contents 00 02_H = 2 (decimal point position)
 Latest word data contents 00 00_H = 0 (vol %)

In the above case, measurement concentration = 12.00 vol%

➤Point➤ For handling of decimal point and unit, refer to Section 7.1.

6.3 Write-in of word data (1 word) [Function code:06_H]

Function code	Max. word number write-in in one message	Relative data address	Register No.
06 _H	1 word	0000 _H – 004C _H	40001 – 40077
		07D0 _H – 07E0 _H	42001 – 42017

(1) Message composition

Command message composition (byte)

Station No.	
Function code	
Write-in designate No. (relative address)	Upper
	Lower
Write-in word data	Upper
	Lower
CRC data	Lower
	Upper

Response message composition (byte)

Station No.	
Function code	
Write-in designate No. (relative address)	Upper
	Lower
Write-in word data	Upper
	Lower
CRC data	Lower
	Upper

(2) Function explanation

Designated word data is written in write-in designate No. Write-in data are transmitted from master station in the order of upper and lower bytes.

(3) Message transmission (example)

The following shows an example of transmitting the “Brightness UP” key command to No.1 station.

Key operation command Relative address: 07D0_H

Command message composition (byte)

Station No.		01 _H
Function code		06 _H
Write-in designate No. (relative address)	Upper	07 _H
	Lower	D0 _H
Write-in word data	Upper	00 _H
	Lower	40 _H
CRC data	Lower	88 _H
	Upper	B7 _H

} “Brightness UP” key command

Response message composition (byte)

Station No.		01 _H
Function code		06 _H
Write-in designate No. (relative address)	Upper	07 _H
	Lower	D0 _H
Write-in word data	Upper	00 _H
	Lower	40 _H
CRC data	Lower	88 _H
	Upper	B7 _H

6.4 Write-in of continuous word data [Function code:10_H]

Function code	Max. word number write-in in one message	Relative data address	Register No.
10 _H	64 words	0000 _H —004C _H	40001—40077

(1) Message composition

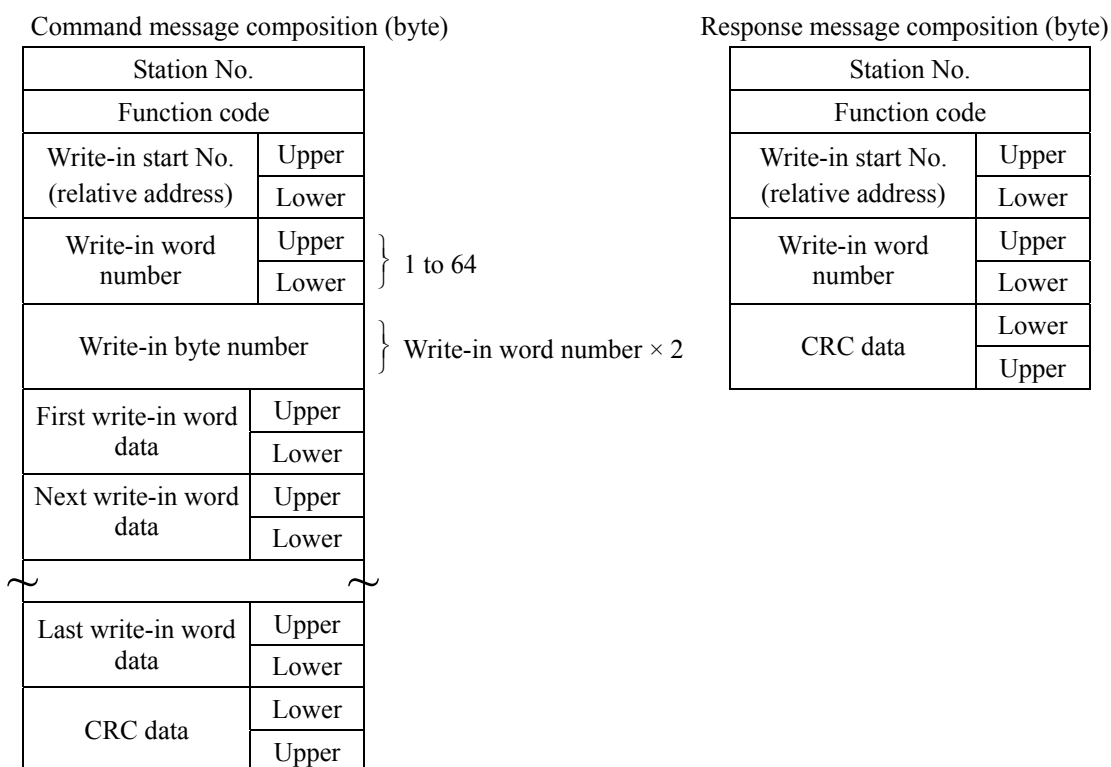

* Arrangement of write-in word data

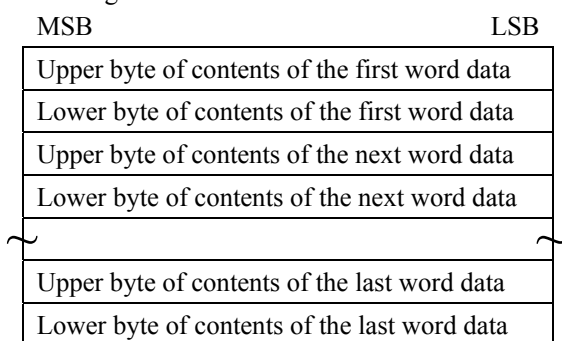

(2) Function explanation

Word data of continuous word number is written from write-in start address. Write-in word data are transmitted from master station in the order of upper and lower bytes.

7. ADDRESS MAP AND DATA FORMAT

7.1 Data format

7.1.1 Transmission data format

The MODBUS protocol used in this instrument is RTU (Remote Terminal Unit) mode. Transmitted data is "numeric value" and not ASCII code."

7.1.2 Handling of decimal point position and measurement unit

When transmitted, the calibration concentration setting, and measurement concentration data have no decimal point nor measurement unit.

Calculate exact values of data upon point positioning as shown below.

- (a) Calibration concentration setting (register No. 40001 to 40030)

You can know the point position for each CH (channel) and each range, and unit upon reading in the decimal point position data (register No. 31036 to 31050), and the unit data (register No. 31006 to 31020).

The decimal point position data has a value of 0, 1, 2 or 3. You can obtain an exact value by the following calculation.

- Case 0: Calibration concentration setting data /1
- Case 1: Calibration concentration setting data /10
- Case 2: Calibration concentration setting data /100
- Case 3: Calibration concentration setting data /1000

The unit data has a value of 0, 1, 2 or 3, that corresponds as follows.

- Case 0: vol%
- Case 1: ppm
- Case 2: mg/m³
- Case 3: g/m³

For example, if:

- CH1 range-1 span calibration concentration setting (register No. 40002) = 5000,
- CH1 range-1 decimal point position (register No. 31036) = 1, and
- CH1 range-1 unit (register No. 31006) = 1,

the value is 500.0 ppm.

For writing-in, proceed in the reverse. To obtain 500.0 ppm, write 5000 as calibration concentration setting.

The decimal point position and unit are unchangeable because fixed to each CH and each range.

(b) Measurement concentration (register No. 30001 to 30024)

The decimal point position and measurement unit for each concentration are stored in registers following that of concentration, and can be known by reading them in.

The meaning of decimal point position data and measurement unit data values are the same as in (a) above.

For example, if:

CH3 measurement concentration (register No. 30007) = 1270,

CH3 decimal point position (register No. 30008) = 2,

CH3 measurement unit (register No. 30009) = 0,

the value is 12.70 vol%

7.1.3 Handling at measurement data over-range

Even if the measurement data is at over-range, with "----" displayed on the screen, the concentration that stands then is transmitted as read-out measurement concentration.

7.2 Address map

For details of functions and settable ranges of different parameters, refer to the instruction manual for the analyzer.

Word data [read-out/write-in]: Function code [03_H, 06_H, 10_H]

	Relative address	Register No.	Data type	Memory contents	Read-out/write-in data	Set item	Remarks	Type	
Menu mode	0000 _H	40001	Word	CH1 range-1 zero calibration concentration	0 to 9999 Decimal point position depends on range	1. Zero/span calibration “Calibration concentration value”	Note 1	F/S	
	0001 _H	40002	Word	CH1 range-1 span calibration concentration				F/S	
	0002 _H	40003	Word	CH1 range-2 zero calibration concentration				Note 1	F/S
	0003 _H	40004	Word	CH1 range-2 span calibration concentration					F/S
	0004 _H	40005	Word	CH1 range-3 zero calibration concentration				Note 1	F/S
	0005 _H	40006	Word	CH1 range-3 span calibration concentration					F/S
	0006 _H	40007	Word	CH2 range-1 zero calibration concentration				Note 1	F/S
	0007 _H	40008	Word	CH2 range-1 span calibration concentration					F/S
	0008 _H	40009	Word	CH2 range-2 zero calibration concentration				Note 1	F/S
	0009 _H	40010	Word	CH2 range-2 span calibration concentration					F/S
	000A _H	40011	Word	CH2 range-3 zero calibration concentration				Note 1	F/S
	000B _H	40012	Word	CH2 range-3 span calibration concentration					F/S
	000C _H	40013	Word	CH3 range-1 zero calibration concentration				Note 1	F/S
	000D _H	40014	Word	CH3 range-1 span calibration concentration					F/S
	000E _H	40015	Word	CH3 range-2 zero calibration concentration				Note 1	F/S
	000F _H	40016	Word	CH3 range-2 span calibration concentration					F/S
	0010 _H	40017	Word	CH3 range-3 zero calibration concentration				Note 1	F/S
	0011 _H	40018	Word	CH3 range-3 span calibration concentration					F/S
	0012 _H	40019	Word	CH4 range-1 zero calibration concentration				Note 1	F/S
	0013 _H	40020	Word	CH4 range-1 span calibration concentration					F/S
0014 _H	40021	Word	CH4 range-2 zero calibration concentration		Note 1	F/S			
0015 _H	40022	Word	CH4 range-2 span calibration concentration			F/S			
0016 _H	40023	Word	CH4 range-3 zero calibration concentration		Note 1	F/S			
0017 _H	40024	Word	CH4 range-3 span calibration concentration			F/S			

Word data [read-out/write-in]: Function code [03_H, 06_H, 10_H]

	Relative address	Register No.	Data type	Memory contents	Read-out/write-in data	Set item	Remarks	Type	
Menu mode	0018 _H	40025	Word	CH5 range-1 zero calibration concentration	0 to 9999 Decimal point position depends on range	1. Zero/span calibration "Calibration concentration value"	Note 1	F/S	
	0019 _H	40026	Word	CH5 range-1 span calibration concentration				F/S	
	001A _H	40027	Word	CH5 range-2 zero calibration concentration				Note 1	F/S
	001B _H	40028	Word	CH5 range-2 span calibration concentration					F/S
	001C _H	40029	Word	CH5 range-3 zero calibration concentration				Note 1	F/S
	001D _H	40030	Word	CH5 range-3 span calibration concentration					F/S
	001E _H	40031	Word	Calibration component selection	ZSVF 0: "Wet Air, Dry" *(1) 1: "Wet N ₂ , Dry" ZSVS 0: "Air" *(1) 1: "Dry N ₂ "	1. Zero/span calibration "Zero calibration operation"		F/S	
	001F _H	40032	Word	CH1 zero calibration switch	0: Does not perform calibration. 1: Performs calibration.			F/S	
	0020 _H	40033	Word	CH2 zero calibration switch				F/S	
	0021 _H	40034	Word	CH3 zero calibration switch				F/S	
	0022 _H	40035	Word	CH4 zero calibration switch				F/S	
	0023 _H	40036	Word	CH5 zero calibration switch				F/S	
	0024 _H	40037	Word	CH1 span calibration state	0: Range "Single" calibration 1: Range "Interlock" calibration	1. Zero/span calibration "Span calibration operation"		F/S	
	0025 _H	40038	Word	CH2 span calibration state				F/S	
	0026 _H	40039	Word	CH3 span calibration state				F/S	
	0027 _H	40040	Word	CH4 span calibration state				F/S	
	0028 _H	40041	Word	CH5 span calibration state				F/S	
	0029 _H	40042	Word	Zero gas feed time	"180 to 999" seconds	2. Calibration time/Calibration cycle "Setting for zero calibration time/cycle"		F/S	
	002A _H	40043	Word	Auto zero calibration switch	0: "OFF," 1: "ON"			F	
	002B _H	40044	Word	Auto zero calibration cycle	"1 to 12" hours			F	
	002C _H	40045	Word	Substitution/purge time	"30 to 300" seconds	3. Substitution/purge setting "Substitution/purge time"		F/S	
	002D _H	40046	Word	CH1 range switching setting	0: "Range value 1" 1: "Range value 2" 2: "Range value 3"	4. Changeover of range "Measurement range"		F/S	
	002E _H	40047	Word	CH2 range switching setting				F/S	
	002F _H	40048	Word	CH3 range switching setting				F/S	
	0030 _H	40049	Word	CH4 range switching setting				F/S	
	0031 _H	40050	Word	CH5 range switching setting				F/S	
	0032 _H	40051	Word	Draining time	"30 to 60" seconds	5. Drain "Time/cycle setting"		F	
	0033 _H	40052	Word	Draining cycle	"1 to 8" hours			F	

Note 1: Register Nos. "40001, 40003, 40005, 40007, 40009, 40011, 40013, 40015, 40017, 40019, 40021, 40023, 40025, 40027, 40029" (Do not write the value other than "0000_H" as zero calibration concentration value for the ranges 1 to 3 of CH1 to CH5 [except for those of special specifications].)

Word data [read-out/write-in]: Function code [03_H, 06_H, 10_H]

	Relative address	Register No.	Data type	Memory contents	Read-out/write-in data	Set item	Remarks	Type
Parameter mode	0034 _H	40053	Word	Month setting	Month: "Jan. to Dec."	Setting for date/time		F/S
	0035 _H	40054	Word	Day setting	Day: "1st to 31st"			F/S
	0036 _H	40055	Word	Hour setting	Hour: "0 to 23"			F/S
	0037 _H	40056	Word	Minute setting	Minute: "00 to 59"			F/S
	0038 _H	40057	Word	Key lock switch	0: "OFF," 1: "ON"	Key lock		F/S
	0039 _H	40058	Word	Output hold switch	0: "OFF," 1: "ON"	Output hold		F/S
	003A _H	40059	Word	Display OFF switch	0: "OFF," 1: "ON"	Display OFF time setting		F/S
	003B _H	40060	Word	Display OFF time cycle	"1 to 30" minutes			F/S
Maintenance mode	003C _H	40061	Word	1st transfer average time	"1 to 4" hours or "1 to 59" minutes	2. Output average time "Average time"		F/S
	003D _H	40062	Word	2nd transfer average time				F/S
	003E _H	40063	Word	3rd transfer average time				F/S
	003F _H	40064	Word	1st transfer average time unit	0: Hour 1: Minute	"Average hour and minute"		F/S
	0040 _H	40065	Word	2nd transfer average time unit				F/S
	0041 _H	40066	Word	3rd transfer average time unit				F/S
	0042 _H	40067	Word	Oxygen conversion reference value	"0 to 19" %	5. Oxygen conversion setting		F/S
	0043 _H	40068	Word	Moisture interference adjustment value NO _x	"-9999 to 9999"	6. Moisture interference adjustment		F/S
	0044 _H	40069	Word	Moisture interference adjustment value SO ₂				F/S
	0045 _H	40070	Word	Station No.	"1 to 31"	7. Transmission station No.		F/S
	0046 _H	40071	Word	Response time 1	"1 to 60" seconds *(2)	8. Response time		F/S
	0047 _H	40072	Word	Response time 2				F/S
	0048 _H	40073	Word	Response time 3				F/S
	0049 _H	40074	Word	Response time 4				F/S
004A _H	40075	Word	Response time O ₂ meter				F/S	
004B _H	40076	Word	Minus display selection	0: Minus display "ON" 1: Minus display "OFF"	9. Minus display setting		F/S	
004C _H	40077	Word	Maintenance mode password	"0000 to 9999"	10. Password setting		F/S	
Menu mode	004D _H	40078	Word	Zero calibration before measurement	0: Calibration "ON," 1: Calibration "OFF"	Zero calibration before measurement		F
	004E _H	40079	Word	CP, CO measurement condition	0: Actual measured value, 1: Fixed value	CO concentration value		F/S
	004F _H	40080	Word	CP, CO fixed concentration value	"10.0 to 40.0"	CO fixed concentration value		F/S
	0050 _H	40081	Word	CP furnace temperature	"800 to 1000"	Furnace temperature value		F/S

Word data [write-in only]: Function code [06_H]**(Write one word at a time.)**

Relative address	Register No.	Data type	Memory contents	Write-in data	Remarks	Type
07D0 _H	42001	Word	Key operation command	01H: MODE, 02H: Bottom, 04H: Side, 08H: ENT, 10H: ESC, 20H: MEAS, 40H: Brightness UP, 80H: Brightness DOWN		F/S
07D1 _H	42002	Word	Screen switching	1: Returns to measurement screen.		F/S
07D2 _H	42003	Word	Drain discharge	1: Drains drain pot. 2: Drains zero gas pot. 3: Drains in batch.		F
07D3 _H	42004	Word	Error cancel	1: Cancels error.		F/S
07D4 _H	42005	Word	Zero calibration	1: Performs zero calibration.		F/S
07D5 _H	42006	Word	O ₂ Air zero calibration	1: Performs O ₂ Air zero calibration.		F/S
07D6 _H	42007	Word	CH1 span calibration	1: Performs CH1 span calibration.		F/S
07D7 _H	42008	Word	CH2 span calibration	1: Performs CH2 span calibration.		F/S
07D8 _H	42009	Word	CH3 span calibration	1: Performs CH3 span calibration.		F/S
07D9 _H	42010	Word	CH4 span calibration	1: Performs CH4 span calibration.		F/S
07DA _H	42011	Word	CH5 span calibration	1: Performs CH5 span calibration.		F/S
07DB _H	42012	Word	Output average value reset	1: Resets average output value.		F/S
07DC _H	42013	Word	Moisture interference adjustment	1: ALL, 2: RESET		F/S
07DD _H	42014	Word	Error log file	1: Clears error log.		F/S
07DE _H	42015		Use prohibited			
07DF _H	42016		Use prohibited			
07E0 _H	42017	Word	Main unit reset	1: Resets main unit.		F/S

Word data [read-out only] : Function code [04_H]

Measurement value and status

Relative address	Register No.	Data type	Memory contents	Read-out data	Remarks	Type
0000 _H	30001	Word	CH1 concentration	Concentration: “-9999 to 9999” (value corresponding to indication without decimal point)		F/S
0001 _H	30002	Word	CH1 decimal point position			F/S
0002 _H	30003	Word	CH1 measurement unit			F/S
0003 _H	30004	Word	CH2 concentration	Decimal point position: 0, 1, 2, 3 0: “Concentration/1” 1: “Concentration/10” 2: “Concentration/100” 3: “Concentration/1000”		F/S
0004 _H	30005	Word	CH2 decimal point position			F/S
0005 _H	30006	Word	CH2 measurement unit			F/S
0006 _H	30007	Word	CH3 concentration	Measurement unit: 0, 1, 2, 3 0: “vol%” 1: “ppm” 2: “mg/m ³ ” 3: “g/m ³ ”		F/S
0007 _H	30008	Word	CH3 decimal point position			F/S
0008 _H	30009	Word	CH3 measurement unit			F/S
0009 _H	30010	Word	CH4 concentration	0: “vol%” 1: “ppm” 2: “mg/m ³ ” 3: “g/m ³ ”		F/S
000A _H	30011	Word	CH4 decimal point position			F/S
000B _H	30012	Word	CH4 measurement unit			F/S
000C _H	30013	Word	CH5 concentration	0: “vol%” 1: “ppm” 2: “mg/m ³ ” 3: “g/m ³ ”		F/S
000D _H	30014	Word	CH5 decimal point position			F/S
000E _H	30015	Word	CH5 measurement unit			F/S
000F _H	30016	Word	CH6 concentration	0: “vol%” 1: “ppm” 2: “mg/m ³ ” 3: “g/m ³ ”		F/S
0010 _H	30017	Word	CH6 decimal point position			F/S
0011 _H	30018	Word	CH6 measurement unit			F/S
0012 _H	30019	Word	CH7 concentration	0: “vol%” 1: “ppm” 2: “mg/m ³ ” 3: “g/m ³ ”		F/S
0013 _H	30020	Word	CH7 decimal point position			F/S
0014 _H	30021	Word	CH7 measurement unit			F/S
0015 _H	30022	Word	CH8 concentration	0: “vol%” 1: “ppm” 2: “mg/m ³ ” 3: “g/m ³ ”		F/S
0016 _H	30023	Word	CH8 decimal point position			F/S
0017 _H	30024	Word	CH8 measurement unit			F/S
0018 _H	30025	Word	CH1 current range	0, 1, 2		F/S
0019 _H	30026	Word	CH2 current range	0: “Range 1”		F/S
001A _H	30027	Word	CH3 current range	1: “Range 2”		F/S
001B _H	30028	Word	CH4 current range	2: “Range 3”		F/S
001C _H	30029	Word	CH5 current range			F/S
001D _H	30030	Word	CH1 zero calibration in progress	0, 1		F/S
001E _H	30031	Word	CH2 zero calibration in progress	0: “No”		F/S
001F _H	30032	Word	CH3 zero calibration in progress	1: “Calibration in progress”		F/S
0020 _H	30033	Word	CH4 zero calibration in progress			F/S
0021 _H	30034	Word	CH5 zero calibration in progress			F/S
0022 _H	30035	Word	CH1 span calibration in progress	0, 1		F/S
0023 _H	30036	Word	CH2 span calibration in progress	0: “No”		F/S
0024 _H	30037	Word	CH3 span calibration in progress	1: “Calibration in progress”		F/S
0025 _H	30038	Word	CH4 span calibration in progress			F/S
0026 _H	30039	Word	CH5 span calibration in progress			F/S

Word data [read-out only] : Function code [04_H]

Measurement value and status

Relative address	Register No.	Data type	Memory contents	Read-out data	Remarks	Type
0027 _H	30040	Word	On standby	0, 1		F/S
0028 _H	30041	Word	Measurement in progress	0: "Without"		F/S
0029 _H	30042	Word	Purging in progress	1: "Operation in progress"		F
002A _H	30043	Word	Substitution in progress			F/S
002B _H	30044	Word	Auto draining in progress			F
002C _H	30045	Word	Drain pot draining in progress			F
002D _H	30046	Word	Zero gas pot draining in progress			F
002E _H	30047	Word	Batch draining in progress			F
002F _H	30048	Word	CH1 auto zero calibration in progress	Auto zero calibration: 0, 1		F
0030 _H	30049	Word	CH1 hold in progress	0: "Without"		F/S
0031 _H	30050	Word	CH2 auto zero calibration in progress	1: "Calibration in progress"		F
0032 _H	30051	Word	CH2 hold in progress			F/S
0033 _H	30052	Word	CH3 auto zero calibration in progress			F
0034 _H	30053	Word	CH3 hold in progress			F/S
0035 _H	30054	Word	CH4 auto zero calibration in progress			F
0036 _H	30055	Word	CH4 hold in progress			F/S
0037 _H	30056	Word	CH5 auto zero calibration in progress			F
0038 _H	30057	Word	CH5 hold in progress			F/S
0039 _H	30058	Word	Instrument error	Error: 0, 1	Error is currently produced.	F/S
003A _H	30059	Word	Calibration error	0: "Without," 1: "With"		F/S
003B _H	30060	Word	Latest error No.	-1 to 9 (Error No. -1)		F/S
003C _H	30061	Word	Latest error MONTH	Jan. to Dec.		F/S
003D _H	30062	Word	Latest error DAY	1st to 31st day		F/S
003E _H	30063	Word	Latest error HOUR	0 to 23 hours		F/S
003F _H	30064	Word	Latest error MIN	0 to 59 minutes		F/S
0040 _H	30065	Word	Latest error CH	0, 1, 2, 3, 4 (CH1 to CH5)		F/S
0041 _H	30066	Word	The previous error No.	Ditto		F/S
0042 _H	30067	Word	The previous error MONTH			F/S
0043 _H	30068	Word	The previous error DAY			F/S
0044 _H	30069	Word	The previous error HOUR			F/S
0045 _H	30070	Word	The previous error MIN			F/S
0046 _H	30071	Word	The previous error CH			F/S
0047 _H	30072	Word	The second previous error No.	Ditto		F/S
0048 _H	30073	Word	The second previous error MONTH			F/S
0049 _H	30074	Word	The second previous error DAY			F/S
004A _H	30075	Word	The second previous error HOUR			F/S
004B _H	30076	Word	The second previous error MIN			F/S
004C _H	30077	Word	The second previous error CH			F/S

Word data [read-out only] : Function code [04_H]

Measurement value and status

Relative address	Register No.	Data type	Memory contents	Read-out data	Remarks	Type
004D _H	30078	Word	The third previous error No.	-1 to 9 (Error No. -1)		F/S
004E _H	30079	Word	The third previous error MONTH	Jan. to Dec.		F/S
004F _H	30080	Word	The third previous error DAY	1st to 31st day		F/S
0050 _H	30081	Word	The third previous error HOUR	0 to 23 hours		F/S
0051 _H	30082	Word	The third previous error MIN	0 to 59 minutes		F/S
0052 _H	30083	Word	The third previous error CH	0, 1, 2, 3, 4 (CH1 to CH5)		F/S
0053 _H	30084	Word	The fourth previous error No.	Ditto		F/S
0054 _H	30085	Word	The fourth previous error MONTH			F/S
0055 _H	30086	Word	The fourth previous error DAY			F/S
0056 _H	30087	Word	The fourth previous error HOUR			F/S
0057 _H	30088	Word	The fourth previous error MIN			F/S
0058 _H	30089	Word	The fourth previous error CH			F/S
0059 _H	30090	Word	The fifth previous error No.	Ditto		F/S
005A _H	30091	Word	The fifth previous error MONTH			F/S
005B _H	30092	Word	The fifth previous error DAY			F/S
005C _H	30093	Word	The fifth previous error HOUR			F/S
005D _H	30094	Word	The fifth previous error MIN			F/S
005E _H	30095	Word	The fifth previous error CH			F/S
005F _H	30096	Word	The sixth previous error No.	Ditto		F/S
0060 _H	30097	Word	The sixth previous error MONTH			F/S
0061 _H	30098	Word	The sixth previous error DAY			F/S
0062 _H	30099	Word	The sixth previous error HOUR			F/S
0063 _H	30100	Word	The sixth previous error MIN			F/S
0064 _H	30101	Word	The sixth previous error CH			F/S
0065 _H	30102	Word	The seventh previous error No.	Ditto		F/S
0066 _H	30103	Word	The seventh previous error MONTH			F/S
0067 _H	30104	Word	The seventh previous error DAY			F/S
0068 _H	30105	Word	The seventh previous error HOUR			F/S
0069 _H	30106	Word	The seventh previous error MIN			F/S
006A _H	30107	Word	The seventh previous error CH			F/S
006B _H	30108	Word	The eighth previous error No.	Ditto		F/S
006C _H	30109	Word	The eighth previous error MONTH			F/S
006D _H	30110	Word	The eighth previous error DAY			F/S
006E _H	30111	Word	The eighth previous error HOUR			F/S
006F _H	30112	Word	The eighth previous error MIN			F/S
0070 _H	30113	Word	The eighth previous error CH			F/S
0071 _H	30114	Word	The ninth previous error No.	Ditto		F/S
0072 _H	30115	Word	The ninth previous error MONTH			F/S
0073 _H	30116	Word	The ninth previous error DAY			F/S
0074 _H	30117	Word	The ninth previous error HOUR			F/S
0075 _H	30118	Word	The ninth previous error MIN			F/S
0076 _H	30119	Word	The ninth previous error CH			F/S

Word data [read-out only] : Function code [04_H]

Measurement value and status

Relative address	Register No.	Data type	Memory contents	Read-out data	Remarks	Type
0077 _H	30120	Word	The tenth previous error No.	-1 to 9 (Error No. -1)		F/S
0078 _H	30121	Word	The tenth previous error MONTH	Jan. to Dec.		F/S
0079 _H	30122	Word	The tenth previous error DAY	1st to 31st day		F/S
007A _H	30123	Word	The tenth previous error HOUR	0 to 23 hours		F/S
007B _H	30124	Word	The tenth previous error MIN	0 to 59 minutes		F/S
007C _H	30125	Word	The tenth previous error CH	0, 1, 2, 3, 4 (CH1 to CH5)		F/S
007D _H	30126	Word	The eleventh previous error No.	Ditto		F/S
007E _H	30127	Word	The eleventh previous error MONTH			F/S
007F _H	30128	Word	The eleventh previous error DAY			F/S
0080 _H	30129	Word	The eleventh previous error HOUR			F/S
0081 _H	30130	Word	The eleventh previous error MIN			F/S
0082 _H	30131	Word	The eleventh previous error CH			F/S
0083 _H	30132	Word	The twelfth previous error No.	Ditto		F/S
0084 _H	30133	Word	The twelfth previous error MONTH			F/S
0085 _H	30134	Word	The twelfth previous error DAY			F/S
0086 _H	30135	Word	The twelfth previous error HOUR			F/S
0087 _H	30136	Word	The twelfth previous error MIN			F/S
0088 _H	30137	Word	The twelfth previous error CH			F/S
0089 _H	30138	Word	Oldest error No.	Ditto		F/S
008A _H	30139	Word	Oldest error MONTH			F/S
008B _H	30140	Word	Oldest error DAY			F/S
008C _H	30141	Word	Oldest error HOUR			F/S
008D _H	30142	Word	Oldest error MIN			F/S
008E _H	30143	Word	Oldest error CH			F/S
008F _H	30144	Word	Error code No. 1	Error: 0, 1		F/S
0090 _H	30145	Word	Error code No. 2	0: "Without," 1: "With"		F/S
0091 _H	30146	Word	Error code No. 3			F/S
0092 _H	30147	Word	CH1 error code No. 4	Ditto		F/S
0093 _H	30148	Word	CH1 error code No. 5			F/S
0094 _H	30149	Word	CH1 error code No. 6			F/S
0095 _H	30150	Word	CH1 error code No. 7			F/S
0096 _H	30151	Word	CH1 error code No. 8			F/S
0097 _H	30152	Word	CH2 error code No. 4	Ditto		F/S
0098 _H	30153	Word	CH2 error code No. 5			F/S
0099 _H	30154	Word	CH2 error code No. 6			F/S
009A _H	30155	Word	CH2 error code No. 7			F/S
009B _H	30156	Word	CH2 error code No. 8			F/S
009C _H	30157	Word	CH3 error code No. 4	Ditto		F/S
009D _H	30158	Word	CH3 error code No. 5			F/S
009E _H	30159	Word	CH3 error code No. 6			F/S
009F _H	30160	Word	CH3 error code No. 7			F/S
00A0 _H	30161	Word	CH3 error code No. 8			F/S

Word data [read-out only] : Function code [04_H]

Measurement value and status

Relative address	Register No.	Data type	Memory contents	Read-out data	Remarks	Type
00A1 _H	30162	Word	CH4 error code No. 4	Error: 0, 1 0: "Without," 1: "With"		F/S
00A2 _H	30163	Word	CH4 error code No. 5			F/S
00A3 _H	30164	Word	CH4 error code No. 6			F/S
00A4 _H	30165	Word	CH4 error code No. 7			F/S
00A5 _H	30166	Word	CH4 error code No. 8			F/S
00A6 _H	30167	Word	CH5 error code No. 4	Ditto		F/S
00A7 _H	30168	Word	CH5 error code No. 5			F/S
00A8 _H	30169	Word	CH5 error code No. 6			F/S
00A9 _H	30170	Word	CH5 error code No. 7			F/S
00AA _H	30171	Word	CH5 error code No. 8			F/S
00AB _H	30172		Do not use			
00AC _H	30173		Do not use			
00AD _H	30174		Do not use			
00AE _H	30175		Do not use			
00AF _H	30176		Do not use			
00B0 _H	30177		Do not use			
00B1 _H	30178		Do not use			
00B2 _H	30179	Word	Sensor input value -1	0 to 65535		F/S
00B3 _H	30180	Word	Sensor input value -2			F/S
00B4 _H	30181	Word	Sensor input value -3			F/S
00B5 _H	30182	Word	Sensor input value -4			F/S
00B6 _H	30183	Word	O ₂ sensor input value			F/S
00B7 _H	30184	Word	Temperature sensor input value			F/S

Word data [read-out only] : Fuction code[04_H]

Fixed setting

Relative address	Register No.	Data type	Memory contents	Read-out data	Remarks	Type
03E8 _H	31001	Word	CH1 range numbers	Number of ranges: 0, 1, 2 0: "Range 1" 1: "Range 2" 2: "Range 3"		F/S
03E9 _H	31002	Word	CH2 range numbers			F/S
03EA _H	31003	Word	CH3 range numbers			F/S
03EB _H	31004	Word	CH4 range numbers			F/S
03EC _H	31005	Word	CH5 range numbers			F/S
03ED _H	31006	Word	CH1 range 1 unit	Range unit: 0, 1, 2 0: "vol%" 1: "ppm" 2: "mg/m ³ " 3: "g/m ³ "		F/S
03EE _H	31007	Word	CH1 range 2 unit			F/S
03EF _H	31008	Word	CH1 range 3 unit			F/S
03F0 _H	31009	Word	CH2 range 1 unit			F/S
03F1 _H	31010	Word	CH2 range 2 unit			F/S
03F2 _H	31011	Word	CH2 range 3 unit			F/S
03F3 _H	31012	Word	CH3 range 1 unit			F/S
03F4 _H	31013	Word	CH3 range 2 unit			F/S
03F5 _H	31014	Word	CH3 range 3 unit			F/S
03F6 _H	31015	Word	CH4 range 1 unit			F/S
03F7 _H	31016	Word	CH4 range 2 unit			F/S
03F8 _H	31017	Word	CH4 range 3 unit			F/S
03F9 _H	31018	Word	CH5 range 1 unit			F/S
03FA _H	31019	Word	CH5 range 2 unit			F/S
03FB _H	31020	Word	CH5 range 3 unit			F/S
03FC _H	31021	Word	CH1 range 1 value	Range value: 0000 to 9999		F/S
03FD _H	31022	Word	CH1 range 2 value			F/S
03FE _H	31023	Word	CH1 range 3 value			F/S
03FF _H	31024	Word	CH2 range 1 value			F/S
0400 _H	31025	Word	CH2 range 2 value			F/S
0401 _H	31026	Word	CH2 range 3 value			F/S
0402 _H	31027	Word	CH3 range 1 value			F/S
0403 _H	31028	Word	CH3 range 2 value			F/S
0404 _H	31029	Word	CH3 range 3 value			F/S
0405 _H	31030	Word	CH4 range 1 value			F/S
0406 _H	31031	Word	CH4 range 2 value			F/S
0407 _H	31032	Word	CH4 range 3 value			F/S
0408 _H	31033	Word	CH5 range 1 value			F/S
0409 _H	31034	Word	CH5 range 2 value			F/S
040A _H	31035	Word	CH5 range 3 value			F/S
040B _H	31036	Word	CH1 range 1 decimal point position	Decimal point position: 0, 1, 2, 3 0: "Nothing below decimal point" 1: "1 digit below decimal point" 2: "2 digits below decimal point" 3: "3 digits below decimal point"		F/S
040C _H	31037	Word	CH1 range 2 decimal point position			F/S
040D _H	31038	Word	CH1 range 3 decimal point position			F/S
040E _H	31039	Word	CH2 range 1 decimal point position			F/S
040F _H	31040	Word	CH2 range 2 decimal point position			F/S
0410 _H	31041	Word	CH2 range 3 decimal point position		F/S	

Word data [read-out only] : Fuction code[04_H]

Fixed setting

Relative address	Register No.	Data type	Memory contents	Read-out data	Remarks	Type
0411 _H	31042	Word	CH3 range 1 decimal point position	Decimal point position: 0, 1, 2, 3		F/S
0412 _H	31043	Word	CH3 range 2 decimal point position	0: "Nothing below decimal point" 1: "1 digit below decimal point" 2: "2 digits below decimal point" 3: "3 digits below decimal point"		F/S
0413 _H	31044	Word	CH3 range 3 decimal point position			F/S
0414 _H	31045	Word	CH4 range 1 decimal point position			F/S
0415 _H	31046	Word	CH4 range 2 decimal point position			F/S
0416 _H	31047	Word	CH4 range 3 decimal point position			F/S
0417 _H	31048	Word	CH5 range 3 decimal point position			F/S
0418 _H	31049	Word	CH5 range 3 decimal point position			F/S
0419 _H	31050	Word	CH5 range 3 decimal point position			F/S
041A _H	31051	Word	CH1 X1	Concentration calculation X1		F/S
041B _H	31052	Word	CH2 X1			F/S
041C _H	31053	Word	CH3 X1			F/S
041D _H	31054	Word	CH4 X1			F/S
041E _H	31055	Word	CH5 X1			F/S
041F _H	31056	Word	CH1 X2	Concentration calculation X2		F/S
0420 _H	31057	Word	CH2 X2			F/S
0421 _H	31058	Word	CH3 X2			F/S
0422 _H	31059	Word	CH4 X2			F/S
0423 _H	31060	Word	CH5 X2			F/S
0424 _H	31061	Word	CH1 X3	Concentration calculation X3		F/S
0425 _H	31062	Word	CH2 X3			F/S
0426 _H	31063	Word	CH3 X3			F/S
0427 _H	31064	Word	CH4 X3			F/S
0428 _H	31065	Word	CH5 X3			F/S
0429 _H	31066	Word	CH1 X4	Concentration calculation X4		F/S
042A _H	31067	Word	CH2 X4			F/S
042B _H	31068	Word	CH3 X4			F/S
042C _H	31069	Word	CH4 X4			F/S
042D _H	31070	Word	CH5 X4			F/S
042E _H	31071	Word	CH1 X5	Concentration calculation X5		F/S
042F _H	31072	Word	CH2 X5			F/S
0430 _H	31073	Word	CH3 X5			F/S
0431 _H	31074	Word	CH4 X5			F/S
0432 _H	31075	Word	CH5 X5			F/S
0433 _H	31076	Word	CH1 X6	Concentration calculation X6		F/S
0434 _H	31077	Word	CH2 X6			F/S
0435 _H	31078	Word	CH3 X6			F/S
0436 _H	31079	Word	CH4 X6			F/S
0437 _H	31080	Word	CH5 X6			F/S

Word data [read-out only] : Fuction code[04_H]

Fixed setting

Relative address	Register No.	Data type	Memory contents	Read-out data	Remarks	Type
0438 _H	31081	Word	CH1 X7	Concentration calculation X7		F/S
0439 _H	31082	Word	CH2 X7			F/S
043A _H	31083	Word	CH3 X7			F/S
043B _H	31084	Word	CH4 X7			F/S
043C _H	31085	Word	CH5 X7			F/S
043D _H	31086	Word	CH1 X8	Concentration calculation X8		F/S
043E _H	31087	Word	CH2 X8			F/S
043F _H	31088	Word	CH3 X8			F/S
0440 _H	31089	Word	CH4 X8			F/S
0441 _H	31090	Word	CH5 X8			F/S

Note 2) Analyzer type F/S stands for; F = ZSVF type, S = ZSVS type. When data of either F or S is displayed alone, the other analyzer would not be used.

Note 3) For details of *1 and *2, please refer to section “7.3 Supplement” to address map.

7.3 Supplement to address map

*1 Register No. 40031 (calibration component selection)

The following table shows the correspondence between the selected components and the gases represented by them.

1) ZSVF

Wet Air, Dry	Zero gas containing moisture (atmosphere), Span gas not containing moisture
Wet N ₂ , Dry	Zero gas containing moisture (N ₂ gas), Span gas not containing moisture

2) ZSVS

Air	Zero gas (atmosphere), Span gas
Dry N ₂	Calibration gas not containing moisture. Zero gas (N ₂ gas), Span gas

*2 Register No. 40071 to 40074 (Response time 1 to 4)

40075 (Response time O₂ meter)

The following table lists the signals corresponding to response time 1 to 4 and O₂ meter.

Response time 1	1st component detector signal
Response time 2	2nd component detector signal
Response time 3	3rd component detector signal
Response time 4	4th component detector signal
Response time O ₂	O ₂ sensor signal

8. SAMPLE PROGRAM

This chapter concerns data read-out/write-in sample program which operates on N88-Japanese BASIC (*2) for PC-9801 (*1) or compatible PCs.

Note that the program shown here is for reference for you to create a program and not for guaranteeing all actions.

Before executing the program, make sure of the communication conditions in the following procedure.

- Communication speed (baud rate):

Match the conditions with this instrument using SWITCH command and SPEED command of MS-DOS (*3).

For SWITCH command and SPEED command, refer to the reference manual of MS-DOS.

- Data length, stop bits and parity:

Set in this program. Match the conditions with this instrument.

*1 PC-9801 series are products of NEC Corporation.

*2 N88-Japanese BASIC is a registered trade mark of NEC Corporation.

*3 MS-DOS is a registered trade mark of Microsoft Corporation.

(a) Example of data read-out

Operation: Read-out CH1 measurement concentration value.

(Continuous word read-out from read-out only area)

Used function code : 04H

Read-out start register No. : 30001

Read-out word number : 3

```
1000 '-----
1010 ' READ CONTINUOUS WORDS SAMPLE PROGRAM
1020 '-----
1030 '
1040 ' Transmission speed = 9600 bps (selected with SPEED command and SWITCH command of MS-DOS)
1050 '
1060 CLS
1070 DIM CC(255)
1080 '
1100 '----- Send data setting -----
1110 CC(1)=&H01 'Station No. = 1
1120 CC(2)=&H04 'Function code = 04H
1130 CC(3)=&H00 'Upper byte of relative address(0000H) of register No.30001
1140 CC(4)=&H00 'Lower byte of relative address(0000H) of register No.30001
1150 CC(5)=&H00 'Upper byte of read-out word data(0003H)
1160 CC(6)=&H03 'Lower byte of read-out word data(0003H)
1170 COUNT=6
1200 '
1210 '----- CRC code calculation of send data -----
1220 GOSUB *CRC.CALC
1230 CC(7)=CRC.L 'Lower byte of CRC calculation result → Upper byte in message
1240 CC(8)=CRC.H 'Upper byte of CRC calculation result → Lower byte in message
1250 COUNT=COUNT+2
1300 '
1310 '----- Send data -----
1320 PRINT " Sending data > ";
1330 OPEN "COM1:N81NN" AS #1 ' No parity ... "N81NN"
1340
1350
1360 FOR I=1 TO COUNT
1370 PRINT #1,CHR$(CC(I)); 'Writing in transmission port
1380 PRINT RIGHT$("0"+HEX$(CC(I)),2);" "; 'Displaying on screen
1390 NEXT I
1400 '
1410 FOR I=0 TO 12000 :NEXT I ' Interval time
1500 '
1510 '----- Data receive -----
```

```

1520 PRINT
1530 LENGTH=LOC(1) 'Number of data in receiving buffer
1540 IF LENGTH=0 THEN PRINT "No answer" :END
1550 PRINT " Receiving data < ";
1560 FOR I=1 TO LENGTH
1570 X$=INPUT$(1,#1) 'Taking data from receiving buffer
1580 CC(I)=ASC(X$) 'Digitizing and storing
1590 PRINT RIGHT$("0"+HEX$(CC(I)),2);" "; 'Displaying on screen
1600 NEXT I
1610 CLOSE #1
1620 COUNT=LENGTH-2
1630 GOSUB *CRC.CALC
1700 '
1710 '----- Transmission error check -----
1720 PRINT
1730 CRC.L$=RIGHT$("0"+HEX$(CRC.L),2)
1740 CRC.H$=RIGHT$("0"+HEX$(CRC.H),2)
1750 PRINT "CRC calculation = ";CRC.L$;" ";CRC.H$
1760 IF CC(LENGTH-1)<>CRC.L THEN GOTO *ER.MESSAGE
1770 IF CC(LENGTH)<>CRC.H THEN GOTO *ER.MESSAGE
1780 GOTO *PRT.RESULT
1790 *ER.MESSAGE
1800 PRINT "Communication error"
1810 END
1900 '
1910 '----- Display of result -----
1920 *PRT.RESULT
1930
1940 PRINT
1950 VALUE=HEX$(CC(4))+RIGHT$("0"+HEX$(CC(5)),2) '2byte → 1word
1960 DE$=HEX$(CC(6))+RIGHT$("0"+HEX$(CC(7)),2) '2byte → 1word
1970 UN$=HEX$(CC(8))+RIGHT$("0"+HEX$(CC(9)),2) '2byte → 1word
1980
1990 Select Case Val("&H"+DE$)
2000 Case 0
2010 CONC=Val("&H"+Value$)/1
2020 Case 1
2030 CONC=Val("&H"+Value$)/10
2040 Case 2
2050 CONC=Val("&H"+Value$)/100
2060 Case 3
2070 CONC=Val("&H"+Value$)/1000
2080 End Select
2090
2100 Select Case Val("&H"+UN$)
2110 Case 0
2120 UNIT="vol%"
2130 Case 1
2140 UNIT="ppm"
2150 Case 2
2160 UNIT="mg/m3"

```

```

2170      Case 3
2180          UNIT="g/m3"
2190 End Select
2200
2210 Print "CH1 measurement concentration =";CONC;UNIT
2220
2230 END
3000 '
3010 '----- CRC calculation -----
3020 *CRC.CALC          ' For contents, refer to CRC calculation flow chart
3030 CR=&HFFFF
3040 FOR I=1 TO COUNT
3050   CR=CR XOR CC(I)
3060   FOR J=1 TO 8
3070     CT=CR AND &H1
3080     IF CR<0 THEN CH=1 ELSE CH=0:GOTO *CRC.CALC.10
3090     CR=CR AND &H7FFF
3100     *CRC.CALC.10
3110     CR=INT(CR/2)
3120     IF CH=1 THEN CR=CR OR &H4000
3130     IF CT=1 THEN CR=CR XOR &HA001
3140   NEXT J
3150 NEXT I
3160 CRC.L=CR AND &HFF          ' Lower byte of CRC calculation
3170 CRC.H=((CR AND &HFF00)/256 AND &HFF)  ' Upper byte of CRC calculation
3180 RETURN

```

9. TROUBLESHOOTING

If the communication is unavailable, check the following items.

- Whether all devices related to communication are turned on.
- Whether connections are correct.
- Whether the number of connected instruments and connection distance are as specified
- Whether communication conditions coincide between the master station (host computer) and slave stations (instrument)
 - Transmission speed : 9600bps
 - Data length : 8 bits
 - Stop bit : 1 bit
 - Parity : None
- Whether send/receive signal timing conforms to Section 5.6 in this manual.
- Whether the station No. designated as send destination by the master station coincides with the station No. of the connected instrument.
- Whether more than one instrument connected on the same transmission line shares the same station No.

Fuji Electric Co., Ltd.

International Sales Div

Sales Group

Gate City Ohsaki, East Tower, 11-2, Osaki 1-chome,
Shinagawa-ku, Tokyo 141-0032, Japan

<http://www.fujielectric.com>

Phone: 81-3-5435-7280, 7281 Fax: 81-3-5435-7425

<http://www.fujielectric.com/products/instruments/>
