



---

**Instruction Manual**

---

**DIGITAL CONTROLLER  
COMMUNICATION  
FUNCTIONS (MODBUS)**

TYPE: PXH

---

Note: Windows<sup>®</sup> is the registered trade mark of Microsoft Corporation.

Note: Visual Basic<sup>®</sup> is the registered trade mark of Microsoft Corporation.

Note: MODBUS<sup>®</sup> is the registered trade mark of Gould Modicon.

#### **Notice**

- Exemption items from responsibility

The contents of this document may be changed in the future without prior notice.

We paid the utmost care for the accuracy of the contents. However, we are not liable for direct and indirect damages resulting from incorrect descriptions, omission of information, and use of information in this document.

# CONTENTS

---

CONTENTS.....	i
1. COMMUNICATION FUNCTIONS .....	1
1.1 Outline.....	1
2. SPECIFICATIONS.....	2
2.1 Communication Specifications .....	2
3. CONNECTION .....	3
3.1 Communication Terminal Allocation .....	3
3.2 Wiring .....	4
4. SETTING OF COMMUNICATION CONDITION.....	6
4.1 Setting items.....	6
4.2 Setting Operation Method .....	7
5. MODBUS COMMUNICATION PROTOCOL.....	8
5.1 Outline.....	8
5.2 Composition of Message.....	9
5.3 Response of Slave Station .....	11
5.4 Function Code .....	12
5.5 Calculation of Error Check Code (CRC-16).....	13
5.6 Transmission Control Procedure .....	14
5.7 FIX Processing (Cautions in data write) .....	16
6. DETAILS OF MESSAGE .....	17
6.1 Read-out of Word Data [Function code: 03 <sub>H</sub> ] .....	17
6.2 Read-out of Read-out Only Word Data [Function code: 04 <sub>H</sub> ].....	19
6.3 Write-in of Word Data (1 word) [Function code: 06 <sub>H</sub> ].....	21
6.4 Write-in of Continuous Word Data [Function code: 10 <sub>H</sub> ] .....	22
7. ADDRESS MAP AND DATA FORMAT .....	24
7.1 Data Format.....	24
7.2 Communication Address Map.....	30
8. SAMPLE PROGRAM .....	51
9. TROUBLESHOOTING .....	57

# 1. COMMUNICATION FUNCTIONS

## 1.1 Outline

- Via RS-485 interface and PC loader interface, PXH provides communication functions of transmitting and receiving data to and from host computer, programmable controller, graphic panel, etc.
- The communication system consists of master station and slave stations. For RS-485 communication, up to 31 slave stations (PXHs) can be connected per master station.  
Note that, because the master station can communicate with only one slave station at a time, a party to communicate with must be specified by the "Station No." set at each slave station.  
For loader communication, one slave station (PXH) can be connected per master station.
- In order that the master station and slave station can communicate, the format of the transmit/receive data must coincide. For the PXH, the format of the communication data is determined by the MODBUS protocol.
- Please use an RS-232C  $\Leftrightarrow$  RS-485 converter in case of designating a personal computer or other devices which have an RS-232C interface as a master station.

[RS-232C  $\Leftrightarrow$  RS-485 converter] (recommended article)

Type: RC-77 (isolated type)/ RA SYSTEMS make <http://www.ras.co.jp>

Type: K3SC-10 (isolated type)/ OMRON make <http://www.omron.co.jp>

RS-232C communication with PC is available upon connecting Type: ZZPPXH1\*TK4H4563 to PC loader interface where PXH is provided in standard.

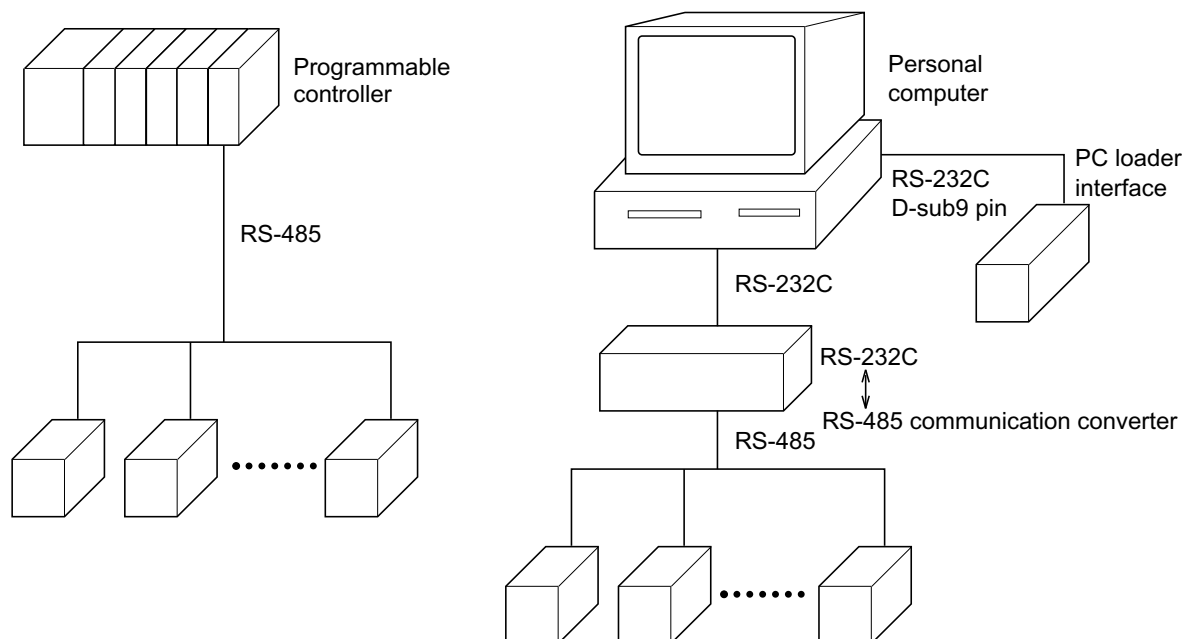

### Caution:

When using the RS-232C  $\Leftrightarrow$  RS-485 converter, pay attention to cable connection between the converter and master station. If the cable is not connected correctly, the master station and slave station cannot communicate. In addition, be careful about communication settings such as baud rate and parity set for the converter.

## 2. SPECIFICATIONS

---

### 2.1 Communication Specifications

#### ■ RS-485

Item	Specification	
Electrical specification	Based on EIA RS-485	
Transmission method	2-wire, half duplex	
Synchronous system	Start-stop synchronous system	
Connection format	1 : N	
Number connectable units	Up to 31 units	
Transmission distance	500m max. (total extension distance)	
Transmission speed	9600bps, 19200bps, 38400bps	
Data format	Data length	8 bits
	Stop bit	1 bit
	Parity	none, even, odd (selectable)
Transmission code	HEX value (MODBUS RTU mode)	
Error detection	CRC-16	
Isolation	Functional isolation between transmission circuit and others (withstand voltage : 500V AC)	

#### ■ PC loader interface

Item	Specification	
Electrical specification	EIA RS232C	
Transmission method	3-wire, half duplex, bit-sereal	
Synchronous system	Start-stop synchronous system	
Connection format	1 : 1	
Transmission speed	9600bps, 19200bps, 38400bps	
Data format	Data length	8 bits
	Stop bit	1 bit
	Parity	none, even, odd (selectable)
Transmission code	HEX value (MODBUS RTU mode)	
Error detection	CRC-16	
Isolation	Non-isolated from internal circuit	

### 3. CONNECTION

---



#### WARNING

For avoiding electric shock and malfunctions, do not turn on the power supply until all wiring is completed.

#### 3.1 Communication Terminal Allocation

##### ■ PXH9 (RS-485)

Terminal number	(14)	(15)	(16)
Signal name	RS485 ⊕	SG	RS485 ⊖

##### ■ PXH9 (PC loader interface)

PC loader interface

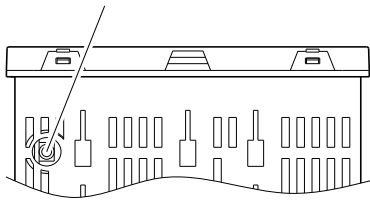

Φ2.5, 3-pole miniature jack

## 3.2 Wiring

### ■ RS-485

- Use twisted pair cables with shield. Recommended: KPEV-SB (Furukawa Electric make)
- The total extension length of the cable is up to 500 m. A master station and up to 31 units of the PXH can be connected per line.
- Both ends of the cable should be terminated with terminating resistors  $100\Omega$  ( $1/2W$  or more).
- If the PXH is to be installed where the level of noise applied to the PXH may exceed 1000 V, it is recommended to install a noise filter in the master station side as below.

Recommended noise filter: ZRAC2203-11 (TDK make)

- If problematic in EMC at communication, loading the communication cable with ferrite can lower the noise level.

Recommended ferrite core: ZCAT series (TDK make)

MSFC series (Morimiya Electric make)

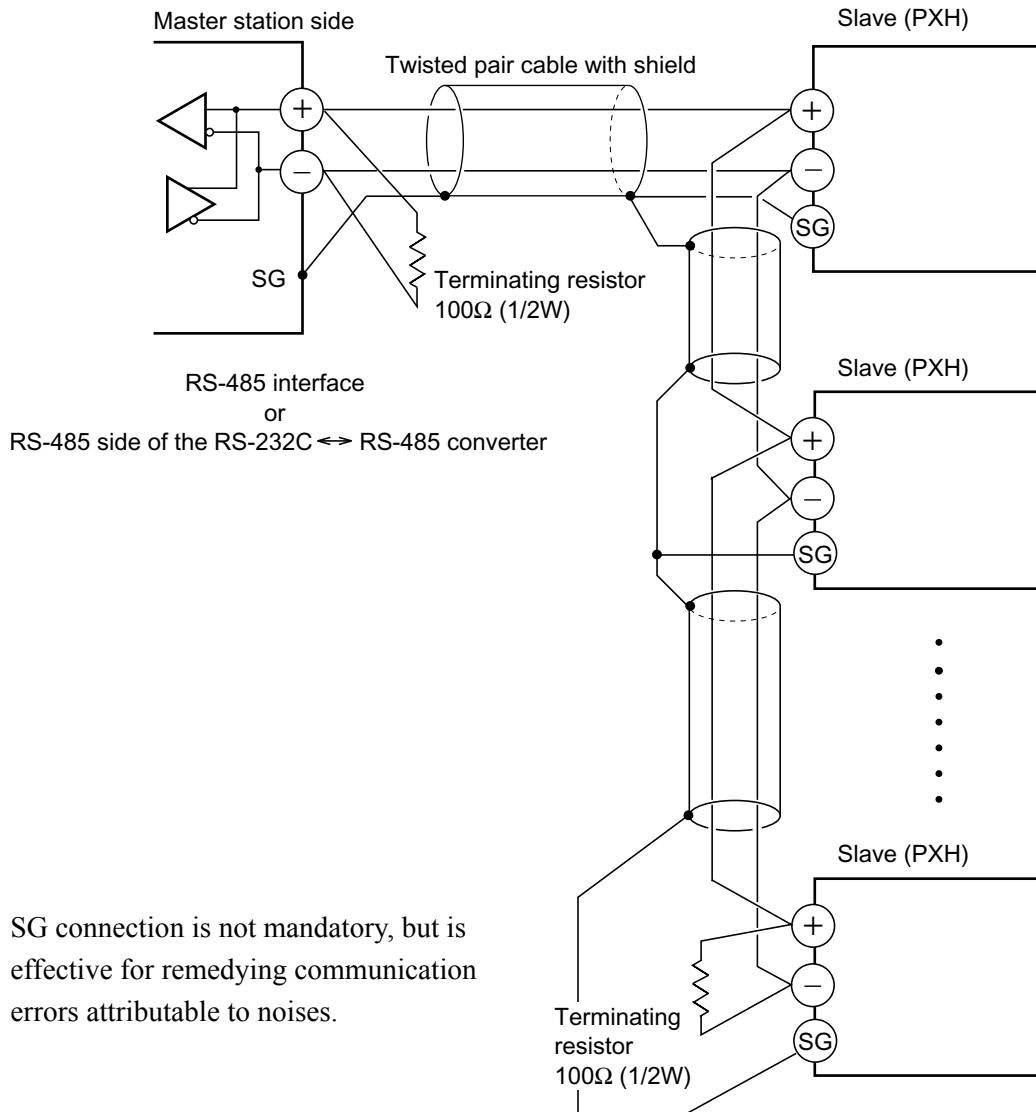
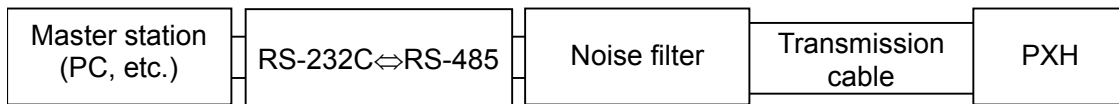

- SG connection is not mandatory, but is effective for remedying communication errors attributable to noises.

---

■ **PC loader communication**

- Use an optional PC loader communication cable (RS-232C).

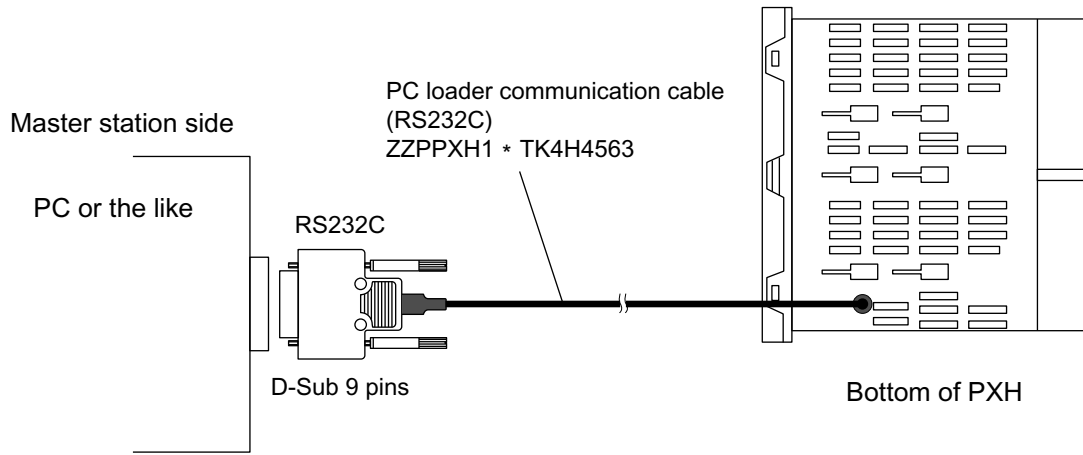



## 4. SETTING OF COMMUNICATION CONDITION

In order that the master station and instrument (PXH) can correctly communicate, following settings are required.

- All communication condition settings of the master station and those of instruments (PXH) are identical.
- For RS-485 communication, different "station numbers (STN4)" are assigned to all PXHs which are connected to a common line. (Any "Station No." is not shared by more than one instrument.)
- For PC loader communication, the station No. is fixed at "1".

Both for PC loader communication and RS-485 communication, same station No. "1" may be assigned.

### 4.1 Setting items

The parameters to be set are shown in the following table. Set them by operating the front panel keys.

#### ■ RS-485

CH B COM Parameter symbol	Item	Value at delivery	Setting range	Remarks
SPD4	Transmission speed	38400bps	96 : 9600bps 192 : 19200bps 384 : 38400bps	Set the same communication condition to the master station and all slave stations.
----	Data length	8 bits	Fixed (can not be changed)	
----	Stop bit	1 bit	Fixed (can not be changed)	
BIT4	Parity setting	odd	8n : none parity 8o : odd parity 8E : even parity	
STN4	Station No.	1	0 to 255 (0: communication function stop)	Set a different number to each station.

#### ■ PC loader communication

CH B COM Parameter symbol	Item	Value at delivery	Setting range	Remarks
SPD2	Transmission speed	38400bps	96 : 9600bps 192 : 19200bps 384 : 38400bps	Set the same conditions as the master station.
----	Data length	8 bits	Fixed (can not be changed)	
----	Stop bit	1 bit	Fixed (can not be changed)	
BIT2	Parity setting	odd	8n : none parity 8o : odd parity 8E : even parity	
----	Station No.	1	Fixed (can not be changed)	

## 4.2 Setting Operation Method

The following example shows how to set the communication conditions.

Example: For RS-485, set BIT4 parity at even and STN4 at 18.

Key operation	Indication	Description				
	<table border="1"><tr><td></td><td>200</td></tr><tr><td>LP01SV</td><td>200</td></tr></table>		200	LP01SV	200	Operation status (PV/SV indication) or (PV/MV indication)
	200					
LP01SV	200					
SEL	<table border="1"><tr><td></td><td>PS1</td></tr><tr><td></td><td>0000</td></tr></table>		PS1		0000	Press the SEL key to display PS1.
	PS1					
	0000					
∨	<table border="1"><tr><td>b.</td><td>COM</td></tr><tr><td></td><td>Ch</td></tr></table>	b.	COM		Ch	Press the ∨ key repeatedly until b.COM channel appears. (If past over, press the ∧ key to return.)
b.	COM					
	Ch					
SEL	<table border="1"><tr><td>b.</td><td>STN4</td></tr><tr><td>02</td><td>1</td></tr></table>	b.	STN4	02	1	Press the SEL key to display STN4 parameter.
b.	STN4					
02	1					
SEL	<table border="1"><tr><td>b.</td><td>STN4</td></tr><tr><td>02</td><td>00001</td></tr></table>	b.	STN4	02	00001	Press the SEL key. The numeric value on the lower indicator blinks and the setting mode is selected.
b.	STN4					
02	00001					
>∧∨	<table border="1"><tr><td>b.</td><td>STN4</td></tr><tr><td>02</td><td>00018</td></tr></table>	b.	STN4	02	00018	Press the >, ∧, or ∨ key to change the numeric value to 18.
b.	STN4					
02	00018					
SEL	<table border="1"><tr><td>b.</td><td>STN4</td></tr><tr><td>02</td><td>18</td></tr></table>	b.	STN4	02	18	Press the SEL key again. The numeric value stops blinking and the setting is registered.
b.	STN4					
02	18					
∨	<table border="1"><tr><td>b.</td><td>BIT4</td></tr><tr><td>04</td><td>8o</td></tr></table>	b.	BIT4	04	8o	Press the ∨ key to display the BIT4 parameter.
b.	BIT4					
04	8o					
SEL	<table border="1"><tr><td>b.</td><td>BIT4</td></tr><tr><td>04</td><td>8o</td></tr></table>	b.	BIT4	04	8o	Press the SEL key. The numeric value on the lower indicator blinks and the setting mode is selected.
b.	BIT4					
04	8o					
∧∨	<table border="1"><tr><td>b.</td><td>BIT4</td></tr><tr><td>04</td><td>8E</td></tr></table>	b.	BIT4	04	8E	Press the ∧ or ∨ key until the numeric value changes to 8E (even parity).
b.	BIT4					
04	8E					
SEL	<table border="1"><tr><td>b.</td><td>BIT4</td></tr><tr><td>04</td><td>8E</td></tr></table>	b.	BIT4	04	8E	Press the SEL key again. The numeric value stops blinking and the setting is registered.
b.	BIT4					
04	8E					
DISP	<table border="1"><tr><td>b.</td><td>COM</td></tr><tr><td></td><td>Ch</td></tr></table>	b.	COM		Ch	Press the DISP key to resume b.COM channel indication.
b.	COM					
	Ch					
DISP	<table border="1"><tr><td></td><td>200</td></tr><tr><td>LP01SV</td><td>200</td></tr></table>		200	LP01SV	200	Press the DISP key to resume the operation status (PV/SV indication).
	200					
LP01SV	200					

\* Be sure to turn off and on power so that the communication condition settings will affect the control.

# 5. MODBUS COMMUNICATION PROTOCOL

---

## 5.1 Outline

The communication system by the MODBUS protocol is that the communication always starts from the master station and a slave station responds to the received message.

Transmission procedures is as shown below.

- 1) The master station sends a command message to a slave station.
- 2) The slave station checks that the station No. in the received message matches with the own station No. or not.
- 3) If matched, the slave station executes the command and sends back the response message.
- 4) If mismatched, the slave station leaves the command message and wait for the next command message.

- a) In case when the station No. in the received command message matches with the own slave station No.

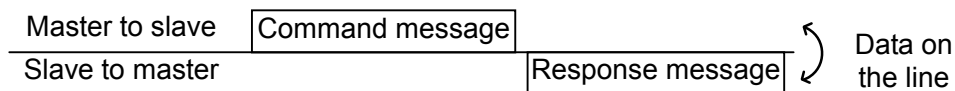

- b) In case when the station No. in the received command message mismatches with the own slave station No.

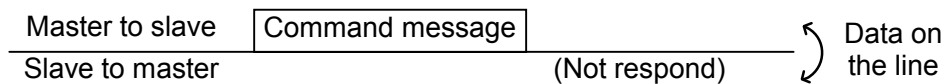

The master station can individually communicate with any one of slave stations connected on the same line upon setting the station No. in the command message.

---

## 5.2 Composition of Message

Command message and response message consist of 4 fields; Station No., Function code, Data and Error check code. And these are sent in the following order.

Station No. (1 byte)
Function code (1 byte)
Data (2 to 69 bytes)
Error check code (CRC-16) (2 bytes)

Fig. 5-1 Composition of message

In the following, each field is explained.

### (1) Station No

Station No. is the number specifying a slave station. For RS-485 communication, the command is processed only by the slave station whose station No. matches with the No. set in the parameter "STN4".

For details of setting the parameter "STN4", refer to chapter 4.

For PC loader communication, the station No. is fixed at "1".

### (2) Function code

This is a code to designate the function executed at a slave station.

For details, refer to section 5.4.

### (3) Data

Data are the data required for executing function codes. The composition of data varies with function codes. For details, refer to chapter 6.

A register number is assigned to each data in the indicating controller. For using the data by communication, designate the register number.

Note that the register number transmitted on message is expressed as its relative address.

The relative address is calculated by the following expression.

$$\boxed{\text{Relative address}} = \left( \text{The lower 4 digits of the } \boxed{\text{Register number}} \right) - 1$$

For example, when the register number designated by a function code is 40003,

$$\begin{aligned} \text{Relative address} &= (\text{lower 4 digits of } 40003) - 1 \\ &= 0002 \end{aligned}$$

is used on the message.

---

**(4) Error check code**

This is the code to detect message errors (change in bit) in the signal transmission.

On the MODBUS protocol (RTU mode), CRC-16 (Cyclic Redundancy Check) is applied.

For CRC calculation method, refer to section 5.5.

---

## 5.3 Response of Slave Station

### (1) Response for normal command

To a relevant message, the slave station creates and sends back a response message which corresponds to the command message. The composition of message in this case is the same as in section 5.2.

Contents of the data field depend on the function code. For details, refer to Chapter 6.

### (2) Response for abnormal command

If contents of a command message have an abnormality (for example, non-actual function code is designated) other than transmission error, the slave station does not execute that command but creates and sends back a response message at error detection.

The composition of response message at error detection is as shown in Fig. 5-2. The value used for function code field is function code of command message plus 80<sub>H</sub>.

Table 5-1 gives error codes.

Station No.
Function code + 80 <sub>H</sub>
Error code
Error check (CRC-16)

Fig. 5-2 Response message at error detection

Table 5-1 Error Code

Error code	Contents	Description
01H	Illegal function code	Non-actual function code is designated. Check for the function code.
02H	Illegal data address	A relative address of register number to which the designated function code can not be used.
03H	Illegal data value	Because the designation of number is too much, the area where register numbers do not exist is designated.

### (3) No response

Under any of the following items, the slave station takes no action of the command message and sends back no response.

- A station number transmitted in the command message differs from the station number specified to the slave station.
- A error check code is not matched, or a transmission error (parity error, etc.) is detected.
- The time interval between the composition data of the message becomes longer than the time corresponding to 24 bits. (Refer to section 5.6 Transmission Control Procedure.)
- Station No. of a slave station is set as 0.
- A write-in command is sent while executing FIX.

## 5.4 Function Code

According to MODBUS protocol, register numbers are assigned by function codes.

Each function code acts on specific register number.

This correspondence is shown in Table 5-2, and the message length by function is shown in Table 5-3.

Table 5-2 Correspondence between function codes and objective address

Function code			Resister No.	
No.	Function	Object	No.	Contents
03 <sub>H</sub>	Read-out (continuously)	Holding register	4xxxx	Read-out/write-in word data
04 <sub>H</sub>	Read-out (continuously)	Input register	3xxxx	Read-out word data
06 <sub>H</sub>	Write-in	Holding register	4xxxx	Read-out/write-in word data
10 <sub>H</sub>	Write-in (continuously)	Holding register	4xxxx	Read-out/write-in word data

Table 5-3 Function code and message length

[Unit:byte]

Function code	Contents	Number of designatable data	Command message		Response message	
			Minimum	Maximum	Minimum	Maximum
03 <sub>H</sub>	Read-out of word data	32 words	8	8	7	69
04 <sub>H</sub>	Read-out of word data (read-out only)	15 words	8	8	7	35
*1 06 <sub>H</sub>	Write-in of word data	1 word	8	8	8	8
10 <sub>H</sub>	Write-in of continuous word data	32 words	11	73	8	8

\*1) For PXH, all data is designated by 2 words.

If 06<sub>H</sub> (write-in of word data) is used, only 1 lower word can be written in, and only 1 upper word cannot.

## 5.5 Calculation of Error Check Code (CRC-16)

CRC-16 is the 2-byte (16-bits) error check code. From the top of the message (station No.) to the end of the data field are calculated.

The slave station calculates the CRC of the received message, and does not respond if the calculated CRC is different from the contents of the received CRC code.

Fig. 5-3 shows the flow of the CRC-16 calculation system.

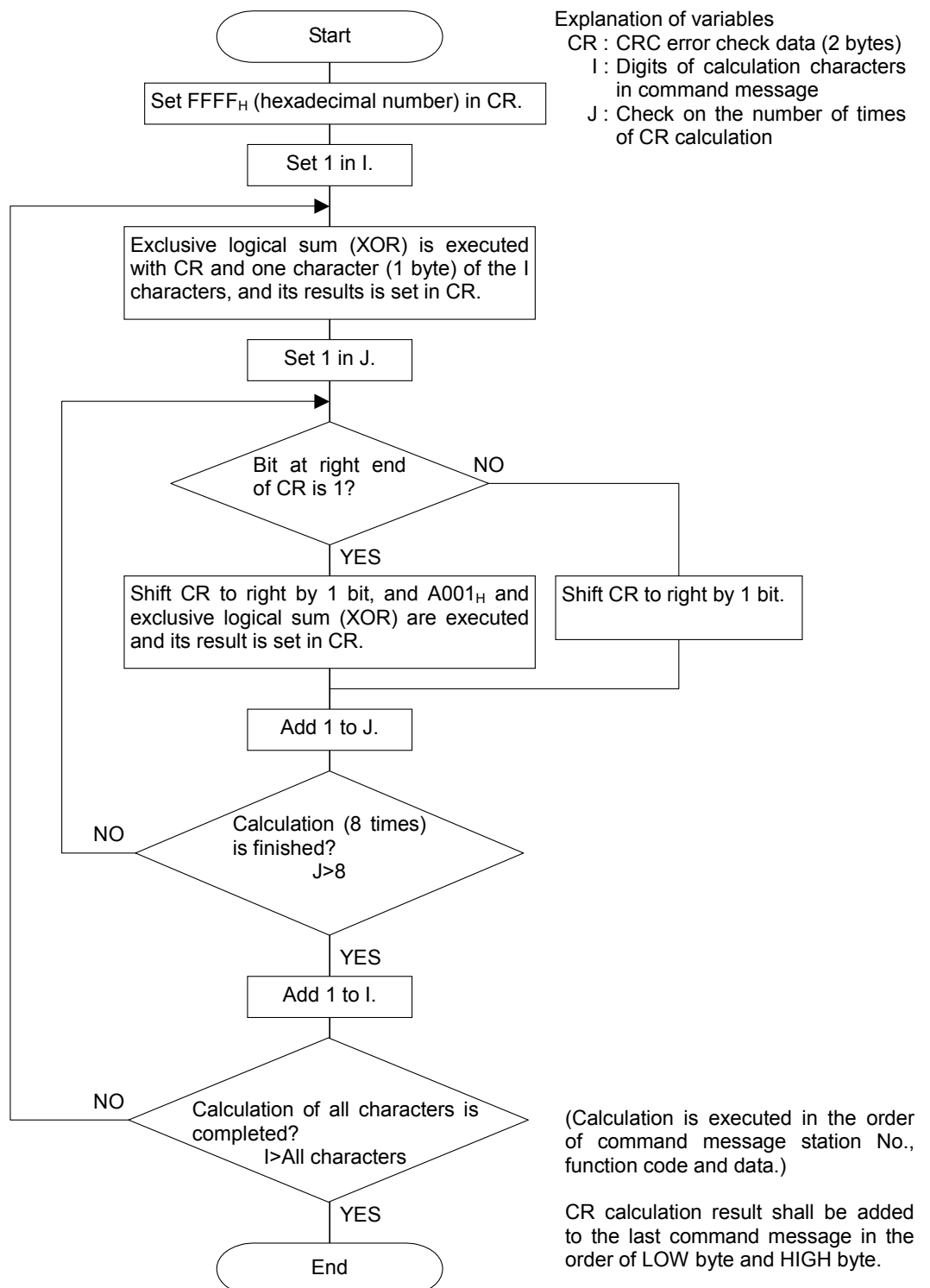

Fig. 5-3 Flow of CRC-16 calculation



---

## 5.6 Transmission Control Procedure

### (1) Transmission procedure of master station

The master station must proceed to a communication upon conforming to the following items.

- (1-1) Before sending a command message, provide 48 bits time or more vacant status.
- (1-2) For 1 command message, each field part should be sent below 24 bits time interval.
- (1-3) Within 24 bits time after sending a command message, receiving stand-by status starts.
- (1-4) Provide 48 bits time or more vacant status between the end of response message reception and beginning of next command message sending [same as in (1-1)].
- (1-5) For ensuring the safety, make a confirmation of the response message and make an arrangement so as to provide 3 or more retries in case of no response, error occurrence, etc.

Note) The above definition is minimum requirement. For ensuring the safety, it's recommended the program for the master should be developed with 2 to 3 times margins. Concretely, it is advised to arrange the program for 9600 bps with 10 ms or more for vacant status (1-1), and within 1 ms for byte interval (1-2) and changeover from sending to receiving (1-3).

### (2) Description

#### 1) Detection of the message frame

Since the communication system uses the 2-wire RS-485 interface, there may be 2 statuses on a line below. (The same goes with PC loader communication.)

- (a) Vacant status (no data on line)
- (b) Communication status (data is existing)

Instruments connected on the line are initially at a receiving status and monitoring the line. When 24 bits time or more vacant status has appeared on the line, the end of preceding frame is assumed and, within following 24 bits time, a stand-by status is posted. When data appears on the line, the instruments enter on receiving, and when 24 bits time or more vacant status is detected again, and the end of that frame is assumed. I.e., data which appeared on the line from the first 24 bits time or more vacant status to the next 24 bits time or more vacant status is fetched as one frame.

Therefore, one frame (command message) must be sent upon confirming the following.

- (1-1) 48 bits time or more vacant status precedes the command message sending.
- (1-2) For 1 command message, each byte should be sent below 24 bits time interval.

#### 2) Response of this instrument (PXH)

After a frame detection (24 bits time or more vacant status is detected), this instrument carries out processing with that frame as a command message. If the command message is addressed to the own station, a response message is returned. Its processing time is about 10 ms (depends on contents of command message).

After sending a command message, therefore, the master station must observe the following

- (1-3) Stand-by status is posted within 24 bits time after sending a command message.

---

Space of longer than 50 ms is needed.  
(longer than 100 ms is recommended.)

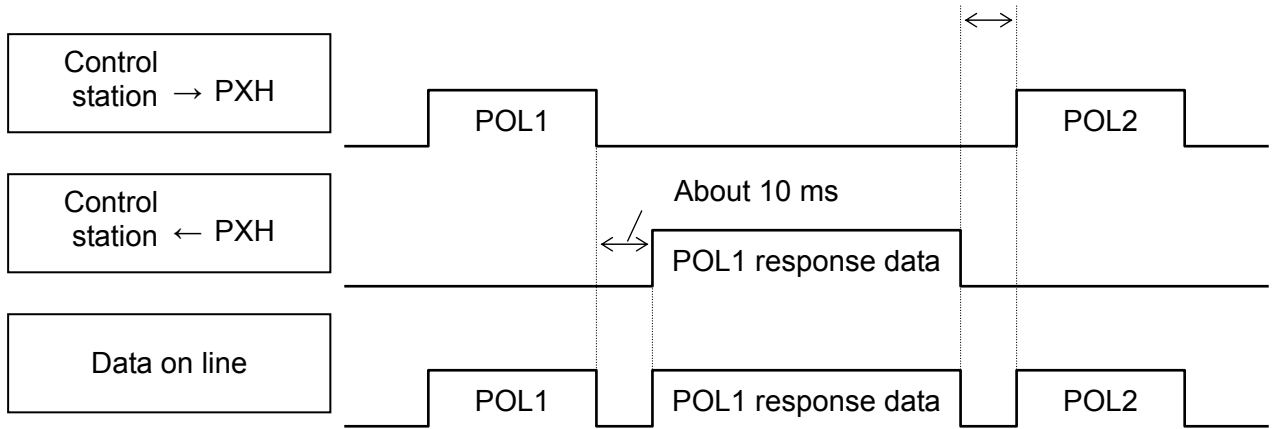

## 5.7 FIX Processing (Cautions in data write)

The instrument is provided inside with a non-volatile memory (EEPROM) for holding the setting parameters. Data written in the non-volatile memory is not lost even if turning off the power.

To hold parameters that were written in the internal memory via communication after turning off the power, the FIX process is effective. It allows parameters to be written in nonvolatile memory.

Fig. 5-4 shows the FIX procedure.

### Cautions:

- FIX processing takes approximately 5 seconds to 3 minutes (depending on how many parameters were changed).
- While writing, do not turn off the power of the PXH. Otherwise, the data in the non-volatile memory will be destroyed, whereby the PXH could not be used any longer.
- Don't change parameters on the front panel when performing the FIX procedure, or memory error may result.
- The non-volatile memory (EEPROM) is a device where the number of write-in times is limited. The guaranteed number of write-in times of the non-volatile memory used on the instrument is 100,000 minimum. Therefore, limit the times of FIX processing to bare minimum, like when setting parameters are changed. Refrain from carrying out the FIX processing periodically for example or while such is not absolutely required.

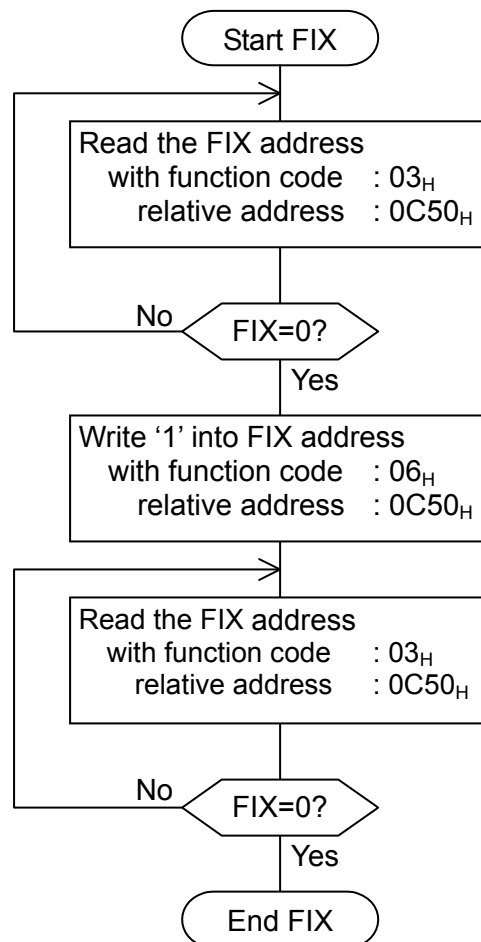

Fig. 5-4 FIX procedure

## 6. DETAILS OF MESSAGE

### 6.1 Read-out of Word Data [Function code: 03<sub>H</sub>]

Function code	Max. word number read-out in one message	Relative data address	Register No.
03 <sub>H</sub>	32 words	0000 <sub>H</sub> – 01388 <sub>H</sub>	40001-45001

#### (1) Message composition

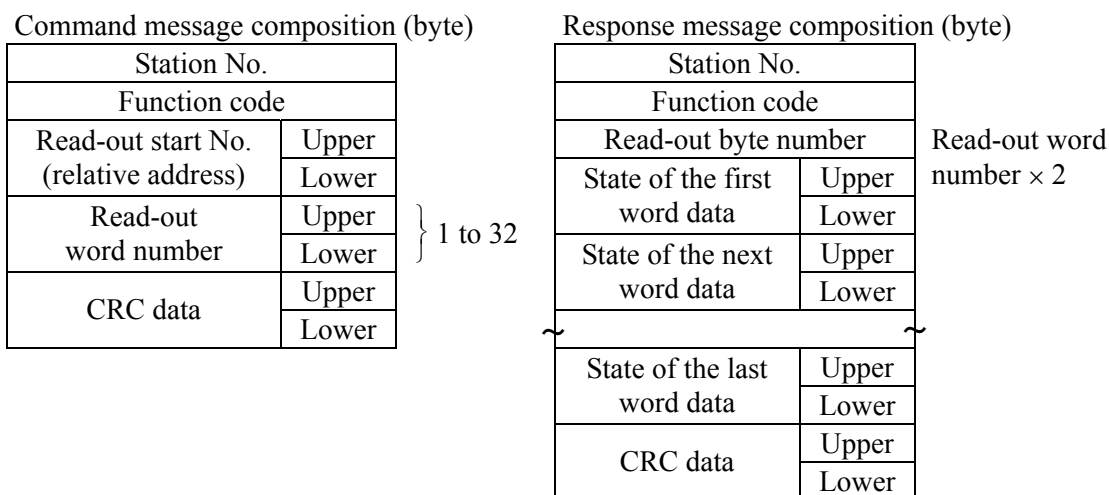

\* Arrangement of read-out word data

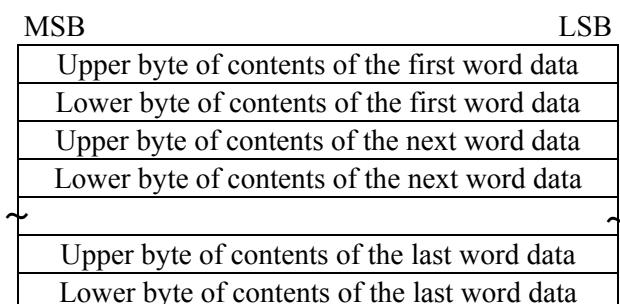

#### (2) Function explanation

Words data are read-out, starting from read-out start No. until read-out word number. The slave station transmits the read-out word data in the order of upper and lower bytes.

For PXH for which all data consists of 2 word units, data should be read out by units of 2 words.

Example: Suppose data is 99999 (00 01 86 9F<sub>H</sub>)

(1) (2) (3) (4)

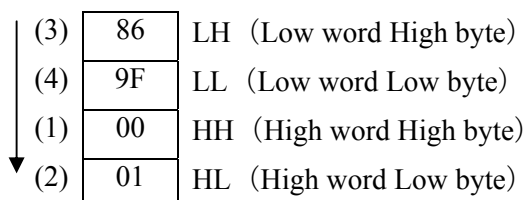

Suppose data is 1

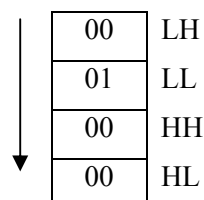

### (3) Message transmission

The following shows an example of reading out PV1F (PV1 full scale) from No. 1 station.

Relative address of PV1F (PV1 full scale): 0830<sub>H</sub>

Number of data words: 02<sub>H</sub> (2 words per data)

Command message composition (byte)

Station No.	01 <sub>H</sub>	
Function code	03 <sub>H</sub>	
Read-out start No. (relative address)	Upper	08 <sub>H</sub>
	Lower	30 <sub>H</sub>
Read-out word number	Upper	00 <sub>H</sub>
	Lower	02 <sub>H</sub>
CRC data	Upper	C6 <sub>H</sub>
	Lower	64 <sub>H</sub>

Response message composition (byte)

Station No.	01 <sub>H</sub>	
Function code	03 <sub>H</sub>	
Read-out byte number	04 <sub>H</sub>	
PV1F lower data	Upper	0F <sub>H</sub>
	Lower	A0 <sub>H</sub>
PV1F upper data	Upper	00 <sub>H</sub>
	Lower	00 <sub>H</sub>
CRC data	Upper	F9 <sub>H</sub>
	Lower	05 <sub>H</sub>

\* Meaning of read-out word data

PV1F (PV1 full scale)

$$\begin{array}{c} \text{Upper data} \\ \underbrace{\quad \quad} \\ 00 \quad 00 \end{array} \quad \begin{array}{c} \text{Lower data} \\ \underbrace{\quad \quad} \\ 0F \quad A0_H \end{array} = 4000$$

## 6.2 Read-out of Read-out Only Word Data [Function code: 04<sub>H</sub>]

Function code	Max. word number read-out in one message	Relative data address	Register No.
04 <sub>H</sub>	15 words	0000 <sub>H</sub> – 057E <sub>H</sub>	30001-31407

### (1) Message composition

Command message composition (byte)			Response message composition (byte)				
Station No.			Station No.				
Function code			Function code				
Read-out start No. (relative address)	Upper	} 1 to 15	Read-out byte number		Read-out word number × 2		
	Lower		State of the first word data	Upper			
Read-out word number	Upper		Lower	State of the next word data	Upper		
	Lower		Lower	Lower	Lower		
CRC data	Upper		~			State of the last word data	Upper
	Lower		Lower	Lower	Lower	Lower	
			CRC data				
			Upper				
			Lower				

\* Arrangement of read-out word data

MSB	LSB
Upper byte of contents of the first word data	
Lower byte of contents of the first word data	
Upper byte of contents of the next word data	
Lower byte of contents of the next word data	
~	
Upper byte of contents of the last word data	
Lower byte of contents of the last word data	

### (2) Function explanation

Words data are read-out, starting from read-out start No. until read-out word number. The slave station transmits the read-out word data in the order of upper and lower bytes.

For PXH for which all data consists of 2 word units, data is read out by units of 2 words.

(1) (2) (3) (4)

Example: Suppose data is -2 (FF FF FF FE<sub>H</sub>)

↓	(3)	FF	LH
	(4)	FE	LL
	(1)	FF	HH
	(2)	FF	HL

### (3) Message transmission

The following shows an example of reading out PV value from No. 1 station.

Relative address of PV value: 0102<sub>H</sub>

Data number: 02<sub>H</sub> (2 words per data)

Command message composition (byte)

Station No.		01 <sub>H</sub>
Function code		04 <sub>H</sub>
Read-out start No. (relative address)	Upper	01 <sub>H</sub>
	Lower	02 <sub>H</sub>
Read-out word number	Upper	00 <sub>H</sub>
	Lower	02 <sub>H</sub>
CRC data	Upper	D1 <sub>H</sub>
	Lower	F7 <sub>H</sub>

Response message composition (byte)

Station No.		01 <sub>H</sub>
Function code		04 <sub>H</sub>
Read-out byte number		04 <sub>H</sub>
PV1 lower data	Upper	38 <sub>H</sub>
	Lower	80 <sub>H</sub>
PV1 upper data	Upper	00 <sub>H</sub>
	Lower	01 <sub>H</sub>
CRC data	Upper	36 <sub>H</sub>
	Lower	CC <sub>H</sub>

#### \* Meaning of read-out word data

PV1 measurement data 00 01 38 80<sub>H</sub> = 80000

If  
 decimal point position    PVID = 2  
 unit                            PV1U = °C                    } 800.00°C

## 6.3 Write-in of Word Data (1 word) [Function code: 06<sub>H</sub>]

Function code	Max. word number write-in in one message	Relative data address	Register No.
06 <sub>H</sub>	1 word	0000 <sub>H</sub> —01388 <sub>H</sub>	40001—45001

### (1) Message composition

Command message composition (byte)

Station No.	
Function code	
Write-in designate No. (relative address)	Upper
	Lower
Write-in word data	Upper
	Lower
CRC data	Upper
	Lower

Response message composition (byte)

Station No.	
Function code	
Write-in designate No. (relative address)	Upper
	Lower
Write-in word data	Upper
	Lower
CRC data	Upper
	Lower

### (2) Function explanation

Designated data is written in word data of write-in designate No. Write-in data are transmitted from master station in the order of upper and lower bytes.

For PXH, all data consist of 2 word units. If 06H (write-in of word data) is used, only 1 lower word of 2 word data can be written in, and only 1 upper word of 2 word data cannot.

### (3) Message transmission (example)

The following shows an example of setting 100.0 (1000<sub>D</sub>=03E8<sub>H</sub>) to the parameter "P1" of No.1 slave station.

Parameter "P1" Relative address: 0282<sub>H</sub>

Command message composition (byte)

Station No.		01 <sub>H</sub>
Function code		06 <sub>H</sub>
Write-in designate No. (relative address)	Upper	02 <sub>H</sub>
	Lower	82 <sub>H</sub>
State of write-in designation	Upper	03 <sub>H</sub>
	Lower	E8 <sub>H</sub>
CRC data	Upper	28 <sub>H</sub>
	Lower	E4 <sub>H</sub>

Response message composition (byte)

Station No.		01 <sub>H</sub>
Function code		06 <sub>H</sub>
Write-in designate No. (relative address)	Upper	02 <sub>H</sub>
	Lower	82 <sub>H</sub>
State of write-in designation	Upper	03 <sub>H</sub>
	Lower	E8 <sub>H</sub>
CRC data	Upper	28 <sub>H</sub>
	Lower	E4 <sub>H</sub>

#### Note

When setting is being locked, response is returned normally, but the command is not executed. Make sure that setting is not locked to send the write-in command.

The setting lock parameter can be written in even if communication setting is invalidated.

If the write-in command message is sent to any slave station during the FIX process, response is not returned from it.



## 6.4 Write-in of Continuous Word Data [Function code: 10<sub>H</sub>]

Function code	Max. word number write-in in one message	Relative data address	Register No.
10 <sub>H</sub>	32 words	0000 <sub>H</sub> —01388 <sub>H</sub>	40001—45001

### (1) Message composition

Command message composition (byte)		Response message composition (byte)	
Station No.		Station No.	
Function code		Function code	
Write-in start No. (relative address)	Upper	Write-in start No. (relative address)	Upper
	Lower		Lower
Write-in word number	Upper	Write-in word number	Upper
	Lower		Lower
Write-in byte number		CRC data	
First write-in word data		Upper	
		Lower	
Next write-in word data		Upper	
		Lower	
Last write-in word data		Upper	
		Lower	
CRC data		Upper	
		Lower	

} 1 to 32  
 } Write-in word number × 2

\* Arrangement of write-in word data

MSB	LSB
Upper byte of contents of the first word data	
Lower byte of contents of the first word data	
Upper byte of contents of the next word data	
Lower byte of contents of the next word data	
Upper byte of contents of the last word data	
Lower byte of contents of the last word data	

### (2) Function explanation

Words data are written in, starting from write-in start No. until write-in word number. Write-in word data are transmitted from master station in the order of upper and lower bytes.

For PXH for which all data consists of 2 word units, write in data by units of 2 words in the order illustrated below.

↓	Lower word, upper byte (LH)
	Lower word, lower byte (LL)
	Upper word, upper byte (HH)
	Upper word, lower byte (HL)

### (3) Message transmission (example)

The following shows an example of writing-in P1 = 100.0, I1 = 10, and D1 = 5.0 to No. 1 slave station.

P1 = 03E8<sub>H</sub> (= 1000<sub>D</sub>)

I1 = 0064<sub>H</sub> (= 100<sub>D</sub>)

D1 = 0032<sub>H</sub> (= 50<sub>D</sub>)

Parameter "P1"    Relative address:0282<sub>H</sub>    Data number:06<sub>H</sub>    (2 words per data)

Command message composition (byte)

Station No.		01 <sub>H</sub>
Function code		10 <sub>H</sub>
Write-in start No.	Upper	02 <sub>H</sub>
	Lower	82 <sub>H</sub>
Write-in word number	Upper	00 <sub>H</sub>
	Lower	06 <sub>H</sub>
Write-in byte number		0C <sub>H</sub>
P1 lower data	Upper	03 <sub>H</sub>
	Lower	E8 <sub>H</sub>
P1 upper data	Upper	00 <sub>H</sub>
	Lower	00 <sub>H</sub>
I1 lower data	Upper	00 <sub>H</sub>
	Lower	64 <sub>H</sub>
I1 upper data	Upper	00 <sub>H</sub>
	Lower	00 <sub>H</sub>
D1 lower data	Upper	00 <sub>H</sub>
	Lower	32 <sub>H</sub>
D1 upper data	Upper	00 <sub>H</sub>
	Lower	00 <sub>H</sub>
CRC data	Upper	B6 <sub>H</sub>
	Lower	D8 <sub>H</sub>

Response message composition (byte)

Station No.		01 <sub>H</sub>
Function code		10 <sub>H</sub>
Write-in start No.	Upper	02 <sub>H</sub>
	Lower	82 <sub>H</sub>
Write-in word number	Upper	00 <sub>H</sub>
	Lower	06 <sub>H</sub>
CRC data	Upper	E1 <sub>H</sub>
	Lower	9B <sub>H</sub>



Since the transmission data can not include a decimal point, data of 100.0 is transmitted as "1000".

For transmission format of each data, refer to the address map (Chapter 7).

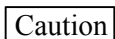

When setting is being locked, response is returned normally. However, the command is not executed. If the write-in command message is sent to any slave station during the FIX process, response is not returned from it.

# 7. ADDRESS MAP AND DATA FORMAT

---

## 7.1 Data Format

### 7.1.1 Transmission data format

The MODBUS protocol used in this instrument (PXH) is RTU (Remote Terminal Unit) mode. Transmitted data is "numeric value" and not "ASCII code".

### 7.1.2 Engineering unit

This instrument can handle set value data or other data which are affected by input range as follows.

Engineering unit: Subjected to scaling to match the actual value according to input range

[Example] The value of "PV = 150" (input range: 0° to 400°C)

	Register No.	Data (HEX)	→	Data (decimal)
Engineering unit	0102	00000096 <sub>H</sub>		150

- How to change the input range setting via communication

The input range setting is for full scale, base scale and decimal point position setting.

In order that the change of input range setting will affect the control, power must be turned off and on, or the reset command must be executed.

Changing the decimal point position automatically changes the full scale and base scale settings.

Example: Changing the input range from 0 to 400, to 0.0 to 400.0

(1) PV1D = 0 → 1 (automatically changes as PV1F = 400 → 400.0, PV1B = 0 → 0.0)

↓

(2) FIX command (see 5.7)

↓

(3) Power OFF-ON or execute reset command (write 1 at relative address 0060H)

- Input range dependent data (see communication address map)

Input range dependent data must be reset after turning off and on power or after transmitting a reset command subsequent to a change of input range.

(1) Input range setting change

↓

(2) FIX command (see 5.7)

↓

(3) Power off and on or execute reset (write 1 at relative address 0060H)

↓

(4) Reset all data depending upon by input range

### 7.1.3 Handling of decimal point

No decimal point is added to transmission data.

For data given in the following table, carry out an alignment of decimal point. (Decimal point should be removed in transmission, and should be added in receiving data.)

Word data [read-out/write-in]

Digits below decimal point	Kind	Register No.	Digits below decimal point	Kind	Register No.	
Designate by UCD1 if TPLT = 10, 11, 30, 31, 50, 51 (0 to 3) Designate by PV1D if TPLT = 13, 14, 33, 34, 53, 54 (0 to 3)	AL1	40257	Designate by UCD1 if TPLT = 10, 11, 30, 31, 50, 51 (0 to 3) Designate by PV1D if TPLT = 13, 14, 33, 34, 53, 54 (0 to 3)	HYS3	41103	
	A1-L	40257		REF3	41111	
	A1-H	40259		SV4	41121	
	AL2	40273		ARH4	41131	
	A2-L	40273		ARL4	41133	
	A2-H	40275		HYS4	41135	
	AL3	40289		REF4	41143	
	A3-L	40289		SV5	41153	
	A3-H	40291		ARH5	41163	
	AL4	40305		ARL5	41165	
	A4-L	40305		HYS5	41167	
	A4-H	40307		REF5	41175	
	AL5	40321		SV6	41185	
	A5-L	40321		ARH6	41195	
	A5-H	40323		ARL6	41197	
	AL6	40337		HYS6	41199	
	A6-L	40337		REF6	41207	
	A6-H	40339		SV7	41217	
	AL7	40353		ARH7	41227	
	A7-L	40353		ARL7	41229	
	A7-H	40355		HYS7	41231	
	AL8	40369		REF7	41239	
	A8-L	40369		Designate by PV1D (0 to 3)	PV1F	42097
	A8-H	40371			PV1B	42099
	1HYS	40265			PV1Z	42107
	2HYS	40281			PV1S	42109
	3HYS	40297		Designate by PV2D (0 to 3)	PV2F	42129
	4HYS	40313			PV2B	42131
	5HYS	40329			PV2Z	42139
	6HYS	40345			PV2S	42141
	7HYS	40361		Designate by AI1D (0 to 3)	AI1F	42193
	8HYS	40377			AI1B	42195
	SV_L1	40641			AI1Z	42203
	ARH1	40651			AI1S	42205
	ARL1	40653		Designate by UCD1 (0 to 3)	UCF1	42081
	SH1	40655			UCB1	42083
	SL1	40657		1 digit below decimal point	P1	40643
	HS1	40671			I1	40645
	SV1	41025			D1	40647
	ARH1	41035			MVH1	40659
ARL1	41037	MVL1	40661			
HYS1	41039	DMV1	40667			
REF1	41047	BAL1	40677			
SV2	41057	PMV1	40685			
ARH2	41067	ALP1	40833			
ARL2	41069	BET1	40841			
HYS2	41071	P-1	41027			
REF2	41079	I-1	41029			
SV3	41089	D-1	41031			
ARH3	41099	BL-1	41045			
ARL3	41101	P-2	41059			

Digits below decimal point	Kind	Register No.	Digits below decimal point	Kind	Register No.
1 digit below decimal point	I-2	41061	Designate by PV1D (0 to 3)	P1XA	43221
	D-2	41063		P1XB	43223
	BL-2	41077		P1XC	43225
	P-3	41091		P1XD	43227
	I-3	41093		P1XE	43229
	D-3	41095		P1XF	43231
	BL-3	41109		P1Y0	43233
	P-4	41123		P1Y1	43235
	I-4	41125		P1Y2	43237
	D-4	41127		P1Y3	43239
	BL-4	41141		P1Y4	43241
	P-5	41155		P1Y5	43243
	I-5	41157		P1Y6	43245
	D-5	41159		P1Y7	43247
	BL-5	41173		P1Y8	43249
	P-6	41187		P1Y9	43251
	I-6	41189		P1YA	43253
	D-6	41191		P1YB	43255
	BL-6	41205		P1YC	43257
	P-7	41219		P1YD	43259
	I-7	41221	P1YE	43261	
	D-7	41223	P1YF	43263	
	BL-7	41237	Designate by PV2D (0 to 3)	P2X0	43265
	P1CU	42117		P2X1	43267
	P1TF	42119		P2X2	43269
	P2CU	42149		P2X3	43271
	P2TF	42151		P2X4	43273
	A1CU	42211		P2X5	43275
	A1TF	42213		P2X6	43277
	AO1L	42435		P2X7	43279
	AO1H	42437		P2X8	43281
	A1LL	42439		P2X9	43283
	A1LH	42441		P2XA	43285
	AO2L	42451		P2XB	43287
	AO2H	42453		P2XC	43289
	A2LL	42455		P2XD	43291
	A2LH	42457		P2XE	43293
	KF1	40849		P2XF	43295
	B1F1	40851		P2Y0	43297
	B2F1	40853		P2Y1	43299
	TrVL	42597		P2Y2	43301
PGP	42599	P2Y3		43303	
Designate by PV1D (0 to 3)	P1X0	43201	P2Y4	43305	
	P1X1	43203	P2Y5	43307	
	P1X2	43205	P2Y6	43309	
	P1X3	43207	P2Y7	43311	
	P1X4	43209	P2Y8	43313	
	P1X5	43211	P2Y9	43315	
	P1X6	43213	P2YA	43317	
	P1X7	43215	P2YB	43319	
	P1X8	43217	P2YC	43321	
	P1X9	43219	P2YD	43323	
		P2YE	43325		
		P2YF	43327		

Digits below decimal point	Kind	Register No.	Digits below decimal point	Kind	Register No.
Designate by A11D (0 to 3)	A1X0	43393	Designate by A11D (0 to 3)	A1Y0	43425
	A1X1	43395		A1Y1	43427
	A1X2	43397		A1Y2	43429
	A1X3	43399		A1Y3	43431
	A1X4	43401		A1Y4	43433
	A1X5	43403		A1Y5	43435
	A1X6	43405		A1Y6	43437
	A1X7	43407		A1Y7	43439
	A1X8	43409		A1Y8	43441
	A1X9	43411		A1Y9	43443
	A1XA	43413		A1YA	43445
	A1XB	43415		A1YB	43447
	A1XC	43417		A1YC	43449
	A1XD	43419		A1YD	43451
	A1XE	43421		A1YE	43453
	A1XF	43423		A1YF	43455

Digits below decimal point	Kind	Register No.	Digits below decimal point	Kind	Register No.
Designate by PV1D (0~3)	Sv-1	41377	Designate by PV1D (0~3)	Sv34	41575
	Sv-2	41383		Sv35	41581
	Sv-3	41389		Sv36	41587
	Sv-4	41395		Sv37	41593
	Sv-5	41401		Sv38	41599
	Sv-6	41407		Sv39	41605
	Sv-7	41413		Sv40	41611
	Sv-8	41419		Sv41	41617
	Sv-9	41425		Sv42	41623
	Sv10	41431		Sv43	41629
	Sv11	41437		Sv44	41635
	Sv12	41443		Sv45	41641
	Sv13	41449		Sv46	41647
	Sv14	41455		Sv47	41653
	Sv15	41461		Sv48	41659
	Sv16	41467		Sv49	41665
	Sv17	41473		Sv50	41671
	Sv18	41479		Sv51	41677
	Sv19	41485		Sv52	41683
	Sv20	41491		Sv53	41689
	Sv21	41497		Sv54	41695
	Sv22	41503		Sv55	41701
	Sv23	41509		Sv56	41707
	Sv24	41515		Sv57	41713
	Sv25	41521		Sv58	41719
	Sv26	41527		Sv59	41725
	Sv27	41533		Sv60	41731
	Sv28	41539		Sv61	41737
	Sv29	41545		Sv62	41743
	Sv30	41551		Sv63	41749
	Sv31	41557		Sv64	41755
	Sv32	41563		GS-h	41353
	Sv33	41569		GS-L	41355

### Word data [read-out only]

Digits below decimal point	Kind	Register No.	Digits below decimal point	Kind	Register No.
Designate by UCD1 if TPLT = 10, 11, 30, 31, 50, 51 (0 to 3) Designate by PV1D if TPLT = 13, 14, 33, 34, 53, 54 (0 to 3)	PV1	30259	Designate by PV1D (0 to 3)	PV1	31025
	SV1	30261			
	DV1	30263	Designate by PV2D (0 to 3)	PV2	31027
			Designate by AI1D (0 to 3)	AI1	31031
Designate by PV1D (0~3)	rSV	30969	Designate by UCD1 (0 to 3)	AIM	31345
1 digit below decimal point			1 digit below decimal point	MV1	30265
				AO1	31105
				AO2	31107
				AMV1	31381
				FFV1	31389
				MVrb	31397
2 digits below decimal point			2 digits below decimal point	RCJ1	31057
				RCJ2	31059

### 7.1.4 Data when input is abnormal

When "UUUU" or "LLLL" is displayed on the face panel on account of over-range, under-range or input burnout for example, PV read-out value (register No. 30259) is 105% or -5% of input range.

Presence of any input abnormality via communication can be detected by:

"Register No. 30269: Input abnormal status"

### 7.1.5 Range of write-in data

When data is written in each parameter, the write-in data should be kept within the setting range. PXH can accept the write-in data beyond the range, however, be careful since the PXH performance will not be guaranteed.

## 7.1.6 Floating decimal point type

The mathematical calculation constant uses the floating decimal point type at communication.

Type name	Sign	Bits
Floating decimal point type	Yes	32 (2 words)

### (1) Floating decimal point type data format

Floating decimal point (float) data of a binary number is expressed by the data format shown in [Fig. 7-1].

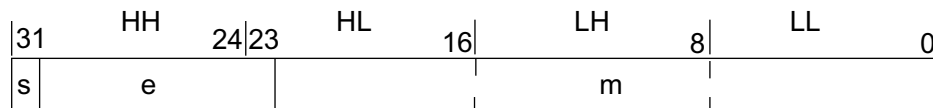

↑  
Decimal point position of mantissa part

s : Sign of mantissa part (1 bit)  
e : Exponent part (8 bits)  
m : Mantissa part (23 bits)

Fig. 7-1 Floating decimal point type data format

## 7.1.7 Setting parameter numbers

Use the following method to change the settings for the parameter number with communication.

CH	-	No.
↓		↓
(Base-32 x 10) + Decimal		

[Ex.] To set 2 - 13 with communication, the value becomes:  
 $733 = 36 \times 2 \times 10 + 13$



## 7.2 Communication Address Map

**Caution:** Never write data into addresses which are not disclosed to users.  
Otherwise a failure may be caused.

For detailed contents about individual parameter function or setting range, refer to the user's manual.

Word data [read-out/write-in] : Function code [03<sub>H</sub>, 06<sub>H</sub>, 10<sub>H</sub>]

Relative address	Register No.	Parameter name	Parameter contents	Read-out data	Write-in data setting range	Affected by input range	Remarks or corresponding parameter
0000H	40001	REM1	Remote mode	0: Auto 1: Remote			
0010H	40017	STBY	Standby command	0: OFF 1: ON			
0012H	40019	PrG	Ramp/soak activation command	oFF : Ramp/soak is stopped. rUn : Ramp/soak starts. hoLd : Ramp/soak hold. GS:GS (out of GS range) End:: Ramp/soak ends	oFF : Ramp/soak is stopped. rUn : Ramp/soak starts. hoLd : Ramp/soak hold.		
0014H	40021	AT	Auto tuning command	0: AT Not activated 1: AT Activated	0: AT Stop 1: AT Execute		
0020H	40033	LACH	Alarm unlatch command	0: Latched 1: Unlatched	0: No effect 1: Unlatch		
0030H	40049	PLTN	Palette signal selection	0 to 7			
0040H	40065	LOC	Key lock	0 to 5			
0060H	40097	RES	Reset command	0: Operating normally 1: Being reset	0: No effect 1: Execute resetting		
0100H	40257	AL1	Alarm 1 setting	▪ Engineering unit setting		*	
0100H	40257	A1-L	Alarm 1 low limit setting	Absolute value alarm: 0 to 100%FS		*	
0102H	40259	A1-H	Alarm 1 high limit setting	Deviation alarm: -100 to 100%FS		*	
0104H	40261	1 TP	Alarm 1 type	0 to 11, 16 to 32, 35 to 38			
0106H	40263	1 OP	Alarm 1 option	0 to 15 (0000B to 1111B)			
0108H	40265	1HYS	Alarm 1 hysteresis	▪ Engineering unit setting (0 to 50%FS)		*	
010AH	40267	1DLY	Alarm 1 delay time	0 to 9999 (sec or min)			
0110H	40273	AL2	Alarm 2 setting	▪ Engineering unit setting		*	
0110H	40273	A2-L	Alarm 2 low limit setting	Absolute value alarm: 0 to 100%FS		*	
0112H	40275	A2-H	Alarm 2 high limit setting	Deviation alarm: -100 to 100%FS		*	
0114H	40277	2 TP	Alarm 2 type	0 to 11, 16 to 32, 35 to 38			
0116H	40279	2 OP	Alarm 2 option	0 to 15 (0000B to 1111B)			
0118H	40281	2HYS	Alarm 2 hysteresis	▪ Engineering unit setting (0 to 50%FS)		*	
011AH	40283	2DLY	Alarm 2 delay time	0 to 9999 (sec or min)			
0120H	40289	AL3	Alarm 3 setting	▪ Engineering unit setting		*	
0120H	40289	A3-L	Alarm 3 low limit setting	Absolute value alarm: 0 to 100%FS		*	
0122H	40291	A3-H	Alarm 3 high limit setting	Deviation alarm: -100 to 100%FS		*	
0124H	40293	3 TP	Alarm 3 type	0 to 11, 16 to 32, 35 to 38			
0126H	40295	3 OP	Alarm 3 option	0 to 15 (0000B to 1111B)			
0128H	40297	3HYS	Alarm 3 hysteresis	▪ Engineering unit setting (0 to 50%FS)		*	
012AH	40299	3DLY	Alarm 3 delay time	0 to 9999 (sec or min)			
0130H	40305	AL4	Alarm 4 setting	▪ Engineering unit setting		*	
0130H	40305	A4-L	Alarm 4 low limit setting	Absolute value alarm: 0 to 100%FS		*	
0132H	40307	A4-H	Alarm 4 high limit setting	Deviation alarm: -100 to 100%FS		*	
0134H	40309	4 TP	Alarm 4 type	0 to 11, 16 to 32, 35 to 38			
0136H	40311	4 OP	Alarm 4 option	0 to 15 (0000B to 1111B)			
0138H	40313	4HYS	Alarm 4 hysteresis	▪ Engineering unit setting (0 to 50%FS)		*	

Relative address	Register No.	Parameter name	Parameter contents	Read-out data	Write-in data setting range	Affected by input range	Remarks or corresponding parameter
013AH	40315	4DLY	Alarm 4 delay time	0 to 9999 (sec or min)			
0140H	40321	AL5	Alarm 5 setting	▪ Engineering unit setting		*	
0140H	40321	A5-L	Alarm 5 low limit setting	Absolute value alarm: 0 to 100%FS		*	
0142H	40323	A5-H	Alarm 5 high limit setting	Deviation alarm: -100 to 100%FS		*	
0144H	40325	5 TP	Alarm 5 type	0 to 11, 16 to 32, 35 to 38			
0146H	40327	5 OP	Alarm 5 option	0 to 15 (0000B to 1111B)			
0148H	40329	5HYS	Alarm 5 hysteresis	▪ Engineering unit setting (0 to 50%FS)		*	
014AH	40331	5DLY	Alarm 5 delay time	0 to 9999 (sec or min)			
0150H	40337	AL6	Alarm 6 setting	▪ Engineering unit setting		*	
0150H	40337	A6-L	Alarm 6 low limit setting	Absolute value alarm: 0 to 100%FS		*	
0152H	40339	A6-H	Alarm 6 high limit setting	Deviation alarm: -100 to 100%FS		*	
0154H	40341	6 TP	Alarm 6 type	0 to 11, 16 to 32, 35 to 38			
0156H	40343	6 OP	Alarm 6 option	0 to 15 (0000B to 1111B)			
0158H	40345	6HYS	Alarm 6 hysteresis	▪ Engineering unit setting (0 to 50%FS)		*	
015AH	40347	6DLY	Alarm 6 delay time	0 to 9999 (sec or min)			
0160H	40353	AL7	Alarm 7 setting	▪ Engineering unit setting		*	
0160H	40353	A7-L	Alarm 7 low limit setting	Absolute value alarm: 0 to 100%FS		*	
0162H	40355	A7-H	Alarm 7 high limit setting	Deviation alarm: -100 to 100%FS		*	
0164H	40357	7 TP	Alarm 7 type	0 to 11, 16 to 32, 35 to 38			
0166H	40359	7 OP	Alarm 7 option	0 to 15 (0000B to 1111B)			
0168H	40361	7HYS	Alarm 7 hysteresis	▪ Engineering unit setting (0 to 50%FS)		*	
016AH	40363	7DLY	Alarm 7 delay time	0 to 9999 (sec or min)			
0170H	40369	AL8	Alarm 8 setting	▪ Engineering unit setting		*	
0170H	40369	A8-L	Alarm 8 low limit setting	Absolute value alarm: 0 to 100%FS		*	
0172H	40371	A8-H	Alarm 8 high limit setting	Deviation alarm: -100 to 100%FS		*	
0174H	40373	8 TP	Alarm 8 type	0 to 11, 16 to 32, 35 to 38			
0176H	40375	8 OP	Alarm 8 option	0 to 15 (0000B to 1111B)			
0178H	40377	8HYS	Alarm 8 hysteresis	▪ Engineering unit setting (0 to 50%FS)		*	
017AH	40379	8DLY	Alarm 8 delay time	0 to 9999 (sec or min)			
0210H	40529	EXM1	External manipulation variable setting	-250 to 1250 (-25.0 to 125.0%)			
0250H	40593	COM-RSV	Communication via remote setting	▪ Engineering unit setting (0 to 100%FS)			
0280H	40641	SV_L1	Local SV	▪ Engineering unit setting (-25 to 125%FS)		*	
0282H	40643	PI	Proportional band	0 to 9999 (0.0 to 999.9%)			
0284H	40645	I1	Integral time	0 to 32000 (0.0 to 3200.0sec)			
0286H	40647	D1	Derivative time	0 to 9999 (0.0 to 999.9sec)			
028AH	40651	ARH1	Anti-reset windup high limit setting	▪ Engineering unit setting (0 to 100%FS)		*	
028CH	40653	ARL1	Anti-reset windup low limit setting			*	
028EH	40655	SH1	SV high limit	▪ Engineering unit setting (-25 to 125%FS)		*	
0290H	40657	SL1	SV low limit	▪ Engineering unit setting (-25 to 125%FS)		*	
0292H	40659	MVH1	MV high limit setting	-250 to 1250 (-25.0 to 125.0%)			
0294H	40661	MVL1	MV low limit setting				
0296H	40663	hC1	MV high limit setting (cool)	-25.0 to 125.0%			
0298H	40665	LC1	MV low limit setting (cool)				
029AH	40667	DMV1	MV change ratio limit setting	0 to 1500 (0.0 to 150.0%)			
029CH	40669	DT1	Sampling rate	5 to 1000 (50 to 10000msec)			
029EH	40671	HS1	Hysteresis setting	▪ Engineering unit setting (0 to 50%FS)		*	
02A4H	40677	BAL1	Manipulating output convergence value	-1000 to 1000 (-100.0 to 100.0%)			
02A6H	40679	TC1	Control output (MV1) proportional period	1 to 150sec			
02A8H	40681	REV1	Control action setting	0: NRML 1: REV			Turn off and on power
02ACH	40685	PMV1	Manipulating output preset value	-250 to 1250 (-25.0 to 125.0%)			
02C6H	40711	hC2	MV high limit setting (cool)	-25.0 to 125.0%			
02C8H	40713	LC2	MV low limit setting (cool)				

Relative address	Register No.	Parameter name	Parameter contents	Read-out data	Write-in data setting range	Affected by input range	Remarks or corresponding parameter
0340H	40833	ALP1	2 degrees of freedom coefficient $\alpha$	-3000 to 3000 (-300.0 to 300.0%)			
0348H	40841	BET1	2 degrees of freedom coefficient $\beta$	0 to 9999 (0.0 to 999.9%)			
0350H	40849	KF1	Sets Feed Forward Gain and bias 1, bias 2. [FF=KF1 × (Input - B1F) + B2F]	-10000 to 10000			
0352H	40851	B1F1					
0354H	40853	B2F1					
0368H	40873	Manual MV1		0.0 to 100.0%			
0400H	41025	SV1	Set value 1	▪ Engineering unit setting (-25 to 125%FS)		*	
0402H	41027	P-1	Pallet 1 proportional band	0 to 9999 (0.0 to 999.9%)			
0404H	41029	I-1	Pallet 1 integral time	0 to 32000 (0.0 to 3200.0sec)			
0406H	41031	D-1	Pallet 1 derivative time	0 to 9999 (0.0 to 999.9sec)			
040AH	41035	ARH1	Pallet 1 anti-reset windup high limit	▪ Engineering unit setting (0 to 100%FS)		*	
040CH	41037	ARL1	Pallet 1 anti-reset windup low limit			*	
040EH	41039	HYS1	Pallet 1 hysteresis setting	▪ Engineering unit setting (0 to 50%FS)		*	
0414H	41045	BL-1	Pallet 1 output convergence value	-1000 to 1000 (-100.0 to 100.0%)			
0416H	41047	REF1	Pallet 1 PID change point	▪ Engineering unit setting (-25 to 125%FS)		*	
0418H	41049	PC-1	Cooling proportional band	0.0 to 999.9%			
041AH	41051	iC-1	Cooling integral time	0.0 to 3200.0 sec			
041CH	41053	dC-1	Cooling derivative time	0.0 to 999.9 sec			
0420H	41057	SV2	Set value 2	▪ Engineering unit setting (-25 to 125%FS)		*	
0422H	41059	P-2	Pallet 2 proportional band	0 to 9999 (0.0 to 999.9%)			
0424H	41061	I-2	Pallet 2 integral time	0 to 32000 (0.0 to 3200.0sec)			
0426H	41063	D-2	Pallet 2 derivative time	0 to 9999 (0.0 to 999.9sec)			
042AH	41067	ARH2	Pallet 2 anti-reset windup high limit	▪ Engineering unit setting (0 to 100%FS)		*	
042CH	41069	ARL2	Pallet 2 anti-reset windup low limit			*	
042EH	41071	HYS2	Pallet 2 hysteresis setting	▪ Engineering unit setting (0 to 50%FS)		*	
0434H	41077	BL-2	Pallet 2 output convergence value	-1000 to 1000 (-100.0 to 100.0%)			
0436H	41079	REF2	Pallet 2 PID change point	▪ Engineering unit setting (-25 to 125%FS)		*	
0438H	41081	PC-2	Cooling proportional band	0.0 to 999.9%			
043AH	41083	iC-2	Cooling integral time	0.0 to 3200.0 sec			
043CH	41085	dC-2	Cooling derivative time	0.0 to 999.9 sec			
0440H	41089	SV3	Set value 3	▪ Engineering unit setting (-25 to 125%FS)		*	
0442H	41091	P-3	Pallet 3 proportional band	0 to 9999 (0.0 to 999.9%)			
0444H	41093	I-3	Pallet 3 integral time	0 to 32000 (0.0 to 3200.0sec)			
0446H	41095	D-3	Pallet 3 derivative time	0 to 9999 (0.0 to 999.9sec)			
044AH	41099	ARH3	Pallet 3 anti-reset windup high limit	▪ Engineering unit setting (0 to 100%FS)		*	
044CH	41101	ARL3	Pallet 3 anti-reset windup low limit			*	
044EH	41103	HYS3	Pallet 3 hysteresis setting	▪ Engineering unit setting (0 to 50%FS)		*	
0454H	41109	BL-3	Pallet 3 output convergence value	-1000 to 1000 (-100.0 to 100.0%)			
0456H	41111	REF3	Pallet 3 PID change point	▪ Engineering unit setting (-25 to 125%FS)		*	
0458H	41113	PC-3	Cooling proportional band	0.0 to 999.9%			
045AH	41115	iC-3	Cooling integral time	0.0 to 3200.0 sec			
045CH	41117	dC-3	Cooling derivative time	0.0 to 999.9 sec			
0460H	41121	SV4	Set value 4	▪ Engineering unit setting (-25 to 125%FS)		*	
0462H	41123	P-4	Pallet 4 proportional band	0 to 9999 (0.0 to 999.9%)			
0464H	41125	I-4	Pallet 4 integral time	0 to 32000 (0.0 to 3200.0sec)			
0466H	41127	D-4	Pallet 4 derivative time	0 to 9999 (0.0 to 999.9sec)			
046AH	41131	ARH4	Pallet 4 anti-reset windup high limit	▪ Engineering unit setting (0 to 100%FS)		*	
046CH	41133	ARL4	Pallet 4 anti-reset windup low limit			*	
046EH	41135	HYS4	Pallet 4 hysteresis setting	▪ Engineering unit setting (0 to 50%FS)		*	

Relative address	Register No.	Parameter name	Parameter contents	Read-out data	Write-in data setting range	Affected by input range	Remarks or corresponding parameter
0474H	41141	BL-4	Pallet 4 output convergence value	-1000 to 1000 (-100.0 to 100.0%)			
0476H	41143	REF4	Pallet 4 PID change point	▪ Engineering unit setting (-25 to 125%FS)		*	
0478H	41145	PC-4	Cooling proportional band	0.0 to 999.9%			
047AH	41147	iC-4	Cooling integral time	0.0 to 3200.0 sec			
047CH	41149	dC-4	Cooling derivative time	0.0 to 999.9 sec			
0480H	41153	SV5	Set value 5	▪ Engineering unit setting (-25 to 125%FS)		*	
0482H	41155	P-5	Pallet 5 proportional band	0 to 9999 (0.0 to 999.9%)			
0484H	41157	I-5	Pallet 5 integral time	0 to 32000 (0.0 to 3200.0sec)			
0486H	41159	D-5	Pallet 5 derivative time	0 to 9999 (0.0 to 999.9sec)			
048AH	41163	ARH5	Pallet 5 anti-reset windup high limit	▪ Engineering unit setting (0 to 100%FS)		*	
048CH	41165	ARL5	Pallet 5 anti-reset windup low limit			*	
048EH	41167	HYS5	Pallet 5 hysteresis setting			*	
0494H	41173	BL-5	Pallet 5 output convergence value	-1000 to 1000 (-100.0 to 100.0%)			
0496H	41175	REF5	Pallet 5 PID change point	▪ Engineering unit setting (-25 to 125%FS)		*	
0498H	41177	PC-5	Cooling proportional band	0.0 to 999.9%			
049AH	41179	iC-5	Cooling integral time	0.0 to 3200.0 sec			
049CH	41181	dC-5	Cooling derivative time	0.0 to 999.9 sec			
04A0H	41185	SV6	Set value 6	▪ Engineering unit setting (-25 to 125%FS)		*	
04A2H	41187	P-6	Pallet 6 proportional band	0 to 9999 (0.0 to 999.9%)			
04A4H	41189	I-6	Pallet 6 integral time	0 to 32000 (0.0 to 3200.0sec)			
04A6H	41191	D-6	Pallet 6 derivative time	0 to 9999 (0.0 to 999.9sec)			
04AAH	41195	ARH6	Pallet 6 anti-reset windup high limit	▪ Engineering unit setting (0 to 100%FS)		*	
04ACH	41197	ARL6	Pallet 6 anti-reset windup low limit			*	
04AEH	41199	HYS6	Pallet 6 hysteresis setting			*	
04B4H	41205	BL-6	Pallet 6 output convergence value	-1000 to 1000 (-100.0 to 100.0%)			
04B6H	41207	REF6	Pallet 6 PID change point	▪ Engineering unit setting (-25 to 125%FS)		*	
04B8H	41209	PC-6	Cooling proportional band	0.0 to 999.9%			
04BAH	41211	iC-6	Cooling integral time	0.0 to 3200.0 sec			
04BCH	41213	dC-6	Cooling derivative time	0.0 to 999.9 sec			
04C0H	41217	SV7	Set value 7	▪ Engineering unit setting (-25 to 125%FS)		*	
04C2H	41219	P-7	Pallet 7 proportional band	0 to 9999 (0.0 to 999.9%)			
04C4H	41221	I-7	Pallet 7 integral time	0 to 32000 (0.0 to 3200.0sec)			
04C6H	41223	D-7	Pallet 7 derivative time	0 to 9999 (0.0 to 999.9sec)			
04CAH	41227	ARH7	Pallet 7 anti-reset windup high limit	▪ Engineering unit setting (0 to 100%FS)		*	
04CCH	41229	ARL7	Pallet 7 anti-reset windup low limit			*	
04CEH	41231	HYS7	Pallet 7 hysteresis setting	▪ Engineering unit setting (0 to 50%FS)		*	
04D4H	41237	BL-7	Pallet 7 output convergence value	-1000 to 1000 (-100.0 to 100.0%)			
04D6H	41239	REF7	Pallet 7 PID change point	▪ Engineering unit setting (-25 to 125%FS)		*	
04D8H	41241	PC-7	Cooling proportional band	0.0 to 999.9%			
04DAH	41243	iC-7	Cooling integral time	0.0 to 3200.0 sec			
04DCH	41245	dC-7	Cooling derivative time	0.0 to 999.9 sec			
04E0H	41249	Mh-1	MV high limit setting	-25.0 to 125.0%			
04E2H	41251	ML-1	MV low limit setting				
04E4H	41253	hC-1	MV high limit setting (cool)				
04E6H	41255	LC-1	MV low limit setting (cool)				
04E8H	41257	Mh-2	MV high limit setting				
04EAH	41259	ML-2	MV low limit setting				
04ECH	41261	hC-2	MV high limit setting (cool)				
04EEH	41263	LC-2	MV low limit setting (cool)				
04F0H	41265	Mh-3	MV high limit setting				
04F2H	41267	ML-3	MV low limit setting				

Relative address	Register No.	Parameter name	Parameter contents	Read-out data	Write-in data setting range	Affected by input range	Remarks or corresponding parameter
04F4H	41269	hC-3	MV high limit setting (cool)	-25.0 to 125.0%			
04F6H	41271	LC-3	MV low limit setting (cool)				
04F8H	41273	Mh-4	MV high limit setting				
04FAH	41275	ML-4	MV low limit setting				
04FCH	41277	hC-4	MV high limit setting (cool)				
04FEH	41279	LC-4	MV low limit setting (cool)				
0500H	41281	Mh-5	MV high limit setting	-25.0 to 125.0%			
0502H	41283	ML-5	MV low limit setting				
0504H	41285	hC-5	MV high limit setting (cool)				
0506H	41287	LC-5	MV low limit setting (cool)				
0508H	41289	Mh-6	MV high limit setting				
050AH	41291	ML-6	MV low limit setting				
050CH	41293	hC-6	MV high limit setting (cool)	-25.0 to 125.0%			
050EH	41295	LC-6	MV low limit setting (cool)				
0510H	41297	Mh-7	MV high limit setting				
0512H	41299	ML-7	MV low limit setting				
0514H	41301	hC-7	MV high limit setting (cool)				
0516H	41303	LC-7	MV low limit setting (cool)				
0518H	41305	hh-1	MV high limit setting (heat)	-25.0 to 125.0%			
051AH	41307	Lh-1	MV low limit setting (heat)				
051CH	41309	hh-2	MV high limit setting (heat)				
051EH	41311	Lh-2	MV low limit setting (heat)				
0520H	41313	hh-3	MV high limit setting (heat)				
0522H	41315	Lh-3	MV low limit setting (heat)				
0524H	41317	hh-4	MV high limit setting (heat)	-25.0 to 125.0%			
0526H	41319	Lh-4	MV low limit setting (heat)				
0528H	41321	hh-5	MV high limit setting (heat)				
052AH	41323	Lh-5	MV low limit setting (heat)				
052CH	41325	hh-6	MV high limit setting (heat)				
052EH	41327	Lh-6	MV low limit setting (heat)				
0530H	41329	hh-7	MV high limit setting (heat)	-25.0 to 125.0%			
0532H	41331	Lh-7	MV low limit setting (heat)				
0540H	41345	PTn	Ramp/soak activation pattern	0~31			
0542H	41347	TiMU	Ramp/soak time units	hh.MM (hour:min) MM.SS (min:sec)			
0544H	41349	Mod	Ramp/soak mode	0~15			
0546H	41351	GSok	Guaranty soak ON/OFF	oFF : Guaranty soak OFF on : Guaranty soak ON			
0548H	41353	GS-h	Guaranty soak band (upper)	0~50%FS		*	
054AH	41355	GS-L	Guaranty soak band (lower)	0~50%FS		*	
054CH	41357	PvST	PV start	oFF : PV start OFF on : PV start ON			
054EH	41359	ConT	Continue mode	rES : Reset (hold) Con : Continue ini : Restart			
0550H	41361	PTnM	Set the Max. pattern	0~31			
0552H	41363	PMin	Set the Min. pattern	0~31			
0560H	41377	Sv-1	(STEP1) Ramp/soak SV setting value	0~100%FS		*	
0562H	41379	TM1r	(STEP1) Ramp time	0 ~ 5999 (min/sec)			
0564H	41381	TM1S	(STEP1) Soak time	0 ~ 5999 (min/sec)			
0566H	41383	Sv-2	(STEP2) Ramp/soak SV setting value	0~100%FS		*	
0568H	41385	TM2r	(STEP2) Ramp time	0 ~ 5999 (min/sec)			
056AH	41387	TM2S	(STEP2) Soak time	0 ~ 5999 (min/sec)			
056CH	41389	Sv-3	(STEP3) Ramp/soak SV setting value	0~100%FS		*	
056EH	41391	TM3r	(STEP3) Ramp time	0 ~ 5999 (min/sec)			
0570H	41393	TM3S	(STEP3) Soak time	0 ~ 5999 (min/sec)			
0572H	41395	Sv-4	(STEP4) Ramp/soak SV setting value	0~100%FS		*	

Relative address	Register No.	Parameter name	Parameter contents	Read-out data	Write-in data setting range	Affected by input range	Remarks or corresponding parameter
0574H	41397	TM4r	(STEP4) Ramp time	1 ~ 5999 (min/sec)			
0576H	41399	TM4S	(STEP4) Soak time	1 ~ 5999 (min/sec)			
0578H	41401	Sv-5	(STEP5) Ramp/soak SV setting value	0~100%FS		*	
057AH	41403	TM5r	(STEP5) Ramp time	0 ~ 5999 (min/sec)			
057CH	41405	TM5S	(STEP5) Soak time	0 ~ 5999 (min/sec)			
057EH	41407	Sv-6	(STEP6) Ramp/soak SV setting value	0~100%FS		*	
0580H	41409	TM6r	(STEP6) Ramp time	0 ~ 5999 (min/sec)			
0582H	41411	TM6S	(STEP6) Soak time	0 ~ 5999 (min/sec)			
0584H	41413	Sv-7	(STEP7) Ramp/soak SV setting value	0~100%FS		*	
0586H	41415	TM7r	(STEP7) Ramp time	0 ~ 5999 (min/sec)			
0588H	41417	TM7S	(STEP7) Soak time	0 ~ 5999 (min/sec)			
058AH	41419	Sv-8	(STEP8) Ramp/soak SV setting value	0~100%FS		*	
058CH	41421	TM8r	(STEP8) Ramp time	0 ~ 5999 (min/sec)			
058EH	41423	TM8S	(STEP8) Soak time	0 ~ 5999 (min/sec)			
0590H	41425	Sv-9	(STEP9) Ramp/soak SV setting value	0~100%FS		*	
0592H	41427	TM9r	(STEP9) Ramp time	0 ~ 5999 (min/sec)			
0594H	41429	TM9S	(STEP9) Soak time	0 ~ 5999 (min/sec)			
0596H	41431	Sv10	(STEP10) Ramp/soak SV setting value	0~100%FS		*	
0598H	41433	T10r	(STEP10) Ramp time	0 ~ 5999 (min/sec)			
059AH	41435	T10S	(STEP10) Soak time	0 ~ 5999 (min/sec)			
059CH	41437	Sv11	(STEP11) Ramp/soak SV setting value	0~100%FS		*	
059EH	41439	T11r	(STEP11) Ramp time	0 ~ 5999 (min/sec)			
05A0H	41441	T11S	(STEP11) Soak time	0 ~ 5999 (min/sec)			
05A2H	41443	Sv12	(STEP12) Ramp/soak SV setting value	0~100%FS		*	
05A4H	41445	T12r	(STEP12) Ramp time	0 ~ 5999 (min/sec)			
05A6H	41447	T12S	(STEP12) Soak time	0 ~ 5999 (min/sec)			
05A8H	41449	Sv13	(STEP13) Ramp/soak SV setting value	0~100%FS		*	
05AAH	41451	T13r	(STEP13) Ramp time	0 ~ 5999 (min/sec)			
05ACH	41453	T13S	(STEP13) Soak time	0 ~ 5999 (min/sec)			
05AEH	41455	Sv14	(STEP14) Ramp/soak SV setting value	0~100%FS		*	
05B0H	41457	T14r	(STEP14) Ramp time	0 ~ 5999 (min/sec)			
05B2H	41459	T14S	(STEP14) Soak time	0 ~ 5999 (min/sec)			
05B4H	41461	Sv15	(STEP15) Ramp/soak SV setting value	0~100%FS		*	
05B6H	41463	T15r	(STEP15) Ramp time	0 ~ 5999 (min/sec)			
05B8H	41465	T15S	(STEP15) Soak time	0 ~ 5999 (min/sec)			
05BAH	41467	Sv16	(STEP16) Ramp/soak SV setting value	0~100%FS		*	
05BCH	41469	T16r	(STEP16) Ramp time	0 ~ 5999 (min/sec)			
05BEH	41471	T16S	(STEP16) Soak time	0 ~ 5999 (min/sec)			
05C0H	41473	Sv17	(STEP17) Ramp/soak SV setting value	0~100%FS		*	
05C2H	41475	T17r	(STEP17) Ramp time	0 ~ 5999 (min/sec)			
05C4H	41477	T17S	(STEP17) Soak time	0 ~ 5999 (min/sec)			
05C6H	41479	Sv18	(STEP18) Ramp/soak SV setting value	0~100%FS		*	
05C8H	41481	T18r	(STEP18) Ramp time	0 ~ 5999 (min/sec)			
05CAH	41483	T18S	(STEP18) Soak time	0 ~ 5999 (min/sec)			
05CCH	41485	Sv19	(STEP19) Ramp/soak SV setting value	0~100%FS		*	
05CEH	41487	T19r	(STEP19) Ramp time	0 ~ 5999 (min/sec)			
05D0H	41489	T19S	(STEP19) Soak time	0 ~ 5999 (min/sec)			
05D2H	41491	Sv20	(STEP20) Ramp/soak SV setting value	0~100%FS		*	

Relative address	Register No.	Parameter name	Parameter contents	Read-out data	Write-in data setting range	Affected by input range	Remarks or corresponding parameter
05D4H	41493	T20r	(STEP20) Ramp time	0 ~ 5999 (min/sec)			
05D6H	41495	T20S	(STEP20) Soak time	0 ~ 5999 (min/sec)			
05D8H	41497	Sv21	(STEP21) Ramp/soak SV setting value	0~100%FS		*	
05DAH	41499	T21r	(STEP21) Ramp time	0 ~ 5999 (min/sec)			
05DCH	41501	T21S	(STEP21) Soak time	0 ~ 5999 (min/sec)			
05DEH	41503	Sv22	(STEP22) Ramp/soak SV setting value	0~100%FS		*	
05E0H	41505	T22r	(STEP22) Ramp time	0 ~ 5999 (min/sec)			
05E2H	41507	T22S	(STEP22) Soak time	0 ~ 5999 (min/sec)			
05E4H	41509	Sv23	(STEP23) Ramp/soak SV setting value	0~100%FS		*	
05E6H	41511	T23r	(STEP23) Ramp time	0 ~ 5999 (min/sec)			
05E8H	41513	T23S	(STEP23) Soak time	0 ~ 5999 (min/sec)			
05EAH	41515	Sv24	(STEP24) Ramp/soak SV setting value	0~100%FS		*	
05ECH	41517	T24r	(STEP24) Ramp time	0 ~ 5999 (min/sec)			
05EEH	41519	T24S	(STEP24) Soak time	0 ~ 5999 (min/sec)			
05F0H	41521	Sv25	(STEP25) Ramp/soak SV setting value	0~100%FS		*	
05F2H	41523	T25r	(STEP25) Ramp time	0 ~ 5999 (min/sec)			
05F4H	41525	T25S	(STEP25) Soak time	0 ~ 5999 (min/sec)			
05F6H	41527	Sv26	(STEP26) Ramp/soak SV setting value	0~100%FS		*	
05F8H	41529	T26r	(STEP26) Ramp time	0 ~ 5999 (min/sec)			
05FAH	41531	T26S	(STEP26) Soak time	0 ~ 5999 (min/sec)			
05FCH	41533	Sv27	(STEP27) Ramp/soak SV setting value	0~100%FS		*	
05FEH	41535	T27r	(STEP27) Ramp time	0 ~ 5999 (min/sec)			
0600H	41537	T27S	(STEP27) Soak time	0 ~ 5999 (min/sec)			
0602H	41539	Sv28	(STEP28) Ramp/soak SV setting value	0~100%FS		*	
0604H	41541	T28r	(STEP28) Ramp time	0 ~ 5999 (min/sec)			
0606H	41543	T28S	(STEP28) Soak time	0 ~ 5999 (min/sec)			
0608H	41545	Sv29	(STEP29) Ramp/soak SV setting value	0~100%FS		*	
060AH	41547	T29r	(STEP29) Ramp time	0 ~ 5999 (min/sec)			
060CH	41549	T29S	(STEP29) Soak time	0 ~ 5999 (min/sec)			
060EH	41551	Sv30	(STEP30) Ramp/soak SV setting value	0~100%FS		*	
0610H	41553	T30r	(STEP30) Ramp time	0 ~ 5999 (min/sec)			
0612H	41555	T30S	(STEP30) Soak time	0 ~ 5999 (min/sec)			
0614H	41557	Sv31	(STEP31) Ramp/soak SV setting value	0~100%FS		*	
0616H	41559	T31r	(STEP31) Ramp time	0 ~ 5999 (min/sec)			
0618H	41561	T31S	(STEP31) Soak time	0 ~ 5999 (min/sec)			
061AH	41563	Sv32	(STEP32) Ramp/soak SV setting value	0~100%FS		*	
061CH	41565	T32r	(STEP32) Ramp time	0 ~ 5999 (min/sec)			
061EH	41567	T32S	(STEP32) Soak time	0 ~ 5999 (min/sec)			
0620H	41569	Sv33	(STEP33) Ramp/soak SV setting value	0~100%FS		*	
0622H	41571	T33r	(STEP33) Ramp time	0 ~ 5999 (min/sec)			
0624H	41573	T33S	(STEP33) Soak time	0 ~ 5999 (min/sec)			
0626H	41575	Sv34	(STEP34) Ramp/soak SV setting value	0~100%FS		*	
0628H	41577	T34r	(STEP34) Ramp time	0 ~ 5999 (min/sec)			
062AH	41579	T34S	(STEP34) Soak time	0 ~ 5999 (min/sec)			
062CH	41581	Sv35	(STEP35) Ramp/soak SV setting value	0~100%FS		*	
062EH	41583	T35r	(STEP35) Ramp time	0 ~ 5999 (min/sec)			
0630H	41585	T35S	(STEP35) Soak time	0 ~ 5999 (min/sec)			
0632H	41587	Sv36	(STEP36) Ramp/soak SV setting value	0~100%FS		*	

Relative address	Register No.	Parameter name	Parameter contents	Read-out data	Write-in data setting range	Affected by input range	Remarks or corresponding parameter
0634H	41589	T36r	(STEP36) Ramp time	0 ~ 5999 (min/sec)			
0636H	41591	T36S	(STEP36) Soak time	0 ~ 5999 (min/sec)			
0638H	41593	Sv37	(STEP37) Ramp/soak SV setting value	0~100%FS		*	
063AH	41595	T37r	(STEP37) Ramp time	0 ~ 5999 (min/sec)			
063CH	41597	T37S	(STEP37) Soak time	0 ~ 5999 (min/sec)			
063EH	41599	Sv38	(STEP38) Ramp/soak SV setting value	0~100%FS		*	
0640H	41601	T38r	(STEP38) Ramp time	0 ~ 5999 (min/sec)			
0642H	41603	T38S	(STEP38) Soak time	0 ~ 5999 (min/sec)			
0644H	41605	Sv39	(STEP39) Ramp/soak SV setting value	0~100%FS		*	
0646H	41607	T39r	(STEP39) Ramp time	0 ~ 5999 (min/sec)			
0648H	41609	T39S	(STEP39) Soak time	0 ~ 5999 (min/sec)			
064AH	41611	Sv40	(STEP40) Ramp/soak SV setting value	0~100%FS		*	
064CH	41613	T40r	(STEP40) Ramp time	0 ~ 5999 (min/sec)			
064EH	41615	T40S	(STEP40) Soak time	0 ~ 5999 (min/sec)			
0650H	41617	Sv41	(STEP41) Ramp/soak SV setting value	0~100%FS		*	
0652H	41619	T41r	(STEP41) Ramp time	0 ~ 5999 (min/sec)			
0654H	41621	T41S	(STEP41) Soak time	0 ~ 5999 (min/sec)			
0656H	41623	Sv42	(STEP42) Ramp/soak SV setting value	0~100%FS		*	
0658H	41625	T42r	(STEP42) Ramp time	0 ~ 5999 (min/sec)			
065AH	41627	T42S	(STEP42) Soak time	0 ~ 5999 (min/sec)			
065CH	41629	Sv43	(STEP43) Ramp/soak SV setting value	0~100%FS		*	
065EH	41631	T43r	(STEP43) Ramp time	0 ~ 5999 (min/sec)			
0660H	41633	T43S	(STEP43) Soak time	0 ~ 5999 (min/sec)			
0662H	41635	Sv44	(STEP44) Ramp/soak SV setting value	0~100%FS		*	
0664H	41637	T44r	(STEP44) Ramp time	0 ~ 5999 (min/sec)			
0666H	41639	T44S	(STEP44) Soak time	0 ~ 5999 (min/sec)			
0668H	41641	Sv45	(STEP45) Ramp/soak SV setting value	0~100%FS		*	
066AH	41643	T45r	(STEP45) Ramp time	0 ~ 5999 (min/sec)			
066CH	41645	T45S	(STEP45) Soak time	0 ~ 5999 (min/sec)			
066EH	41647	Sv46	(STEP46) Ramp/soak SV setting value	0~100%FS		*	
0670H	41649	T46r	(STEP46) Ramp time	0 ~ 5999 (min/sec)			
0672H	41651	T46S	(STEP46) Soak time	0 ~ 5999 (min/sec)			
0674H	41653	Sv47	(STEP47) Ramp/soak SV setting value	0~100%FS		*	
0676H	41655	T47r	(STEP47) Ramp time	0 ~ 5999 (min/sec)			
0678H	41657	T47S	(STEP47) Soak time	0 ~ 5999 (min/sec)			
067AH	41659	Sv48	(STEP48) Ramp/soak SV setting value	0~100%FS		*	
067CH	41661	T48r	(STEP48) Ramp time	0 ~ 5999 (min/sec)			
067EH	41663	T48S	(STEP48) Soak time	0 ~ 5999 (min/sec)			
0680H	41665	Sv49	(STEP49) Ramp/soak SV setting value	0~100%FS		*	
0682H	41667	T49r	(STEP49) Ramp time	0 ~ 5999 (min/sec)			
0684H	41669	T49S	(STEP49) Soak time	0 ~ 5999 (min/sec)			
0686H	41671	Sv50	(STEP50) Ramp/soak SV setting value	0~100%FS		*	
0688H	41673	T50r	(STEP50) Ramp time	0 ~ 5999 (min/sec)			
068AH	41675	T50S	(STEP50) Soak time	0 ~ 5999 (min/sec)			
068CH	41677	Sv51	(STEP51) Ramp/soak SV setting value	0~100%FS		*	
068EH	41679	T51r	(STEP51) Ramp time	0 ~ 5999 (min/sec)			
0690H	41681	T51S	(STEP51) Soak time	0 ~ 5999 (min/sec)			
0692H	41683	Sv52	(STEP52) Ramp/soak SV setting value	0~100%FS		*	



Relative address	Register No.	Parameter name	Parameter contents	Read-out data	Write-in data setting range	Affected by input range	Remarks or corresponding parameter
0694H	41685	T52r	(STEP52) Ramp time	0 ~ 5999 (min/sec)			
0696H	41687	T52S	(STEP52) Soak time	0 ~ 5999 (min/sec)			
0698H	41689	Sv53	(STEP53) Ramp/soak SV setting value	0~100%FS		*	
069AH	41691	T53r	(STEP53) Ramp time	0 ~ 5999 (min/sec)			
069CH	41693	T53S	(STEP53) Soak time	0 ~ 5999 (min/sec)			
069EH	41695	Sv54	(STEP54) Ramp/soak SV setting value	0~100%FS		*	
6A0H	41697	T54r	(STEP54) Ramp time	0 ~ 5999 (min/sec)			
6A2H	41699	T54S	(STEP54) Soak time	0 ~ 5999 (min/sec)			
6A4H	41701	Sv55	(STEP55) Ramp/soak SV setting value	0~100%FS		*	
6A6H	41703	T55r	(STEP55) Ramp time	0 ~ 5999 (min/sec)			
6A8H	41705	T55S	(STEP55) Soak time	0 ~ 5999 (min/sec)			
06AAH	41707	Sv56	(STEP56) Ramp/soak SV setting value	0~100%FS		*	
06ACH	41709	T56r	(STEP56) Ramp time	0 ~ 5999 (min/sec)			
06AEH	41711	T56S	(STEP56) Soak time	0 ~ 5999 (min/sec)			
06BOH	41713	Sv57	(STEP57) Ramp/soak SV setting value	0~100%FS		*	
06B2H	41715	T57r	(STEP57) Ramp time	0 ~ 5999 (min/sec)			
06B4H	41717	T57S	(STEP57) Soak time	0 ~ 5999 (min/sec)			
06B6H	41719	Sv58	(STEP58) Ramp/soak SV setting value	0~100%FS		*	
06B8H	41721	T58r	(STEP58) Ramp time	0 ~ 5999 (min/sec)			
06BAH	41723	T58S	(STEP58) Soak time	0 ~ 5999 (min/sec)			
06BCH	41725	Sv59	(STEP59) Ramp/soak SV setting value	0~100%FS		*	
06BEH	41727	T59r	(STEP59) Ramp time	0 ~ 5999 (min/sec)			
06C0H	41729	T59S	(STEP59) Soak time	0 ~ 5999 (min/sec)			
06C2H	41731	Sv60	(STEP60) Ramp/soak SV setting value	0~100%FS		*	
06C4H	41733	T60r	(STEP60) Ramp time	0 ~ 5999 (min/sec)			
06C6H	41735	T60S	(STEP60) Soak time	0 ~ 5999 (min/sec)			
06C8H	41737	Sv61	(STEP61) Ramp/soak SV setting value	0~100%FS		*	
06CAH	41739	T61r	(STEP61) Ramp time	0 ~ 5999 (min/sec)			
06CCH	41741	T61S	(STEP61) Soak time	0 ~ 5999 (min/sec)			
06CEH	41743	Sv62	(STEP62) Ramp/soak SV setting value	0~100%FS		*	
06D0H	41745	T62r	(STEP62) Ramp time	0 ~ 5999 (min/sec)			
06D2H	41747	T62S	(STEP62) Soak time	0 ~ 5999 (min/sec)			
06D4H	41749	Sv63	(STEP63) Ramp/soak SV setting value	0~100%FS		*	
06D6H	41751	T63r	(STEP63) Ramp time	0 ~ 5999 (min/sec)			
06D8H	41753	T63S	(STEP63) Soak time	0 ~ 5999 (min/sec)			
06DAH	41755	Sv64	(STEP64) Ramp/soak SV setting value	0~100%FS		*	
06DCH	41757	T64r	(STEP64) Ramp time	0 ~ 5999 (min/sec)			
06DEH	41759	T64S	(STEP64) Soak time	0 ~ 5999 (min/sec)			
0700H	41793	PC1	Cooling proportional band	0.0 to 999.9%			
0702H	41795	iC1	Cooling integral time	0.0 to 3200.0 sec			
0704H	41797	dC1	Cooling derivative time	0.0 to 999.9 sec			
0706H	41799	TCC1	Control output (cool) proportional period	1 to 150 sec			
0708H	41801	rVC1	Control operation method (cool)	NRML: Normal operation REV: Reverse operation			
070AH	41803	MKC1	MV output method (cool)	LNR SSR-d			
070CH	41805	PMC1	Manipulating output value (cool)	-25.0 to 125.0%			
070EH	41807	hh1	MV high limit setting (heat)				
0710H	41809	Lh1	MV low limit setting (heat)				
0712H	41811	Ld1	Output limiter type setting	0 to 3			

Relative address	Register No.	Parameter name	Parameter contents	Read-out data	Write-in data setting range	Affected by input range	Remarks or corresponding parameter
0714H	41813	LdC1	Cooling output limiter type setting				
0720H	41825	PC2	Cooling proportional band	0.0 to 999.9%			
0722H	41827	iC2	Cooling integral time	0.0 to 3200.0 sec			
0724H	41829	dC2	Cooling derivative time	0.0 to 999.9 sec			
0726H	41831	TCC2	Control output (cool) proportional period	1 to 150 sec			
0728H	41833	rVC2	Control operation method (cool)	NRML: Normal operation REV: Reverse operation			
072AH	41835	MKC2	MV output method (cool)	LNR SSR-d			
072CH	41837	PMC2	Manipulating output value (cool)	-25.0 to 125.0%			
072EH	41839	hh2	MV high limit setting (heat)				
0730H	41841	Lh2	MV low limit setting (heat)	-25.0 to 125.0%			
0732H	41843	Ld2	Output limiter type setting				
0734H	41845	LdC2	Cooling output limiter type setting	0 to 3			
0820H	42081	UCF1	Mathematical calculation full scale	-19999 to 99999			Turn off and on power
0822H	42083	UCB1	Mathematical calculation base scale				
0824H	42085	UCD1	Mathematical calculation decimal point position	0 to 3			
0830H	42097	PV1F	PV1 full scale	-19999 to 99999			Turn off and on power
0832H	42099	PV1B	PV1 base scale				
0834H	42101	PV1D	PV1 decimal point position	0 to 3			
0836H	42103	PV1T	PV1 input type	0 to 9, 12 to 14, 16 to 20, 26, 27			
0838H	42105	PV1U	PV1 input unit	0: °C 1: °F 2: non			
083AH	42107	PV1Z	PV1 zero adjustment	▪ Engineering unit setting (-50 to 50%FS)	*		
083CH	42109	PV1S	PV1 span adjustment		*		
0844H	42117	P1CU	PV1 input router cut point	-1 to 1250 (-0.1 to 125.0%) (-1: OFF)			
0846H	42119	P1TF	PV1 input filter time constant	0 to 9000 (0.0 to 900.0sec)			
0848H	42121	P1Ln	PV1 linearize setting	(0) OFF (1) nrML (2) hi-C (3) Lo-C			
0850H	42129	PV2F	PV2 full scale	-19999 to 99999			Turn off and on power
0852H	42131	PV2B	PV2 base scale				
0854H	42133	PV2D	PV2 decimal point position	0 to 3			
0856H	42135	PV2T	PV2 input type	0 to 9, 12 to 14, 16 to 20, 26, 27			
0858H	42137	PV2U	PV2 input unit	0: °C 1: °F 2: non			
085AH	42139	PV2Z	PV2 zero adjustment	▪ Engineering unit setting (-50 to 50%FS)	*		
085CH	42141	PV2S	PV2 span adjustment		*		
0864H	42149	P2CU	PV2 input router cut point	-1 to 1250 (-0.1 to 125.0%) (-1: OFF)			
0866H	42151	P2TF	PV2 input filter time constant	0 to 9000 (0.0 to 900.0sec)			
0868H	42153	P2Ln	PV2 linearize setting	(0) OFF (1) nrML (2) hi-C (3) Lo-C			
0890H	42193	A11F	A11 full scale	-19999 to 99999			Turn off and on power
0892H	42195	A11B	A11 base scale				
0894H	42197	A11D	A11 decimal point position	0 to 3			
0896H	42199	A11T	A11 input unit	16 to 18			
089AH	42203	A11Z	A11 zero adjustment	▪ Engineering unit setting (-50 to 50%FS)	*		
089CH	42205	A11S	A11 span adjustment		*		
08A2H	42211	A1CU	A11 input router cut point	-1 to 1250 (-0.1 to 125.0%) (-1: OFF)			

Relative address	Register No.	Parameter name	Parameter contents	Read-out data	Write-in data setting range	Affected by input range	Remarks or corresponding parameter
08A4H	42213	A1TF	A11 input filter time constant	0 to 9000 (0.0 to 900.0sec)			
08A6H	42215	A1Ln	Ai1 linearize setting	(0) OFF (1) nrML (2) hi-C (3) Lo-C			
0970H	42417	AO1T	AO1 output type	1: PV      5: AiM 2: SV      6: S1 3: MV      7: S2 4: DV      8: S3			
0972H	42419	AO2T	AO2 output type				
0982H	42435	AO1L	AO1 output base scale	-1300 to 1300 (-130.0 to 130.0%)			
0984H	42437	AO1H	AO1 output full scale	-1300 to 1300 (-130.0 to 130.0%)			
0986H	42439	A1LL	AO1 output low limit	-250 to 1050 (-25.0 to 105.0%)			
0988H	42441	A1LH	AO1 output high limit				
0992H	42451	AO2L	AO2 output base scale	-1300 to 1300 (-130.0 to 130.0%)			
0994H	42453	AO2H	AO2 output full scale				
0996H	42455	A2LL	AO2 output low limit	-250 to 1050 (-25.0 to 105.0%)			
0998H	42457	A2LH	AO2 output high limit				

Relative address	Register No.	Parameter name	Parameter contents	Read-out data	Write-in data setting range	Affected by input range	Remarks or corresponding parameter
0A00H	42561	CALC	Calculation	0 to 40			
0A02H	42563	TPLT	Template number	10, 11, 13, 14, 16, 30, 31, 33, 34, 50, 51, 53, 54			Turn off and on power
0A04H	42565	OTYP	Output type number	10 to 13, 30, 31, 50 to 55			
0A22H	42595	VTYP	Valve type	FB (0): PFB control FB-Sr (1): PFB + estimated control Sr1 (2): Estimated control 1 Sr2 (3): Estimated control 2 (Valve fully open when power is turned on)			
0A24H	42597	TrVL	Travel time	50 to 3000 (5.0 to 300.0 sec)			
0A26H	42599	PGP	Valve dead zone	50 to 1000 (0.5 to 100.0%)			
0A2CH	42605	AdPC	Valve close adjustment value	0 to 1048575 (00000H to FFFFFH)			
0A2EH	42607	AdPO	Valve open adjustment value	0 to 1048575 (00000H to FFFFFH)			
0A30H	42609	RIH1	Remote setting inhibition	0: OFF 1: ON			
0A40H	42625	RAC1	Whether to use R-ACK or not	0: inhibit 1: enable			
0A50H	42641	A-M1	A/M mode	0: A-M 1: A			
0A60H	42657	CND1	Power-ON starting mode setting	0: Auto 1: Remote 2: Manual			
0A74H	42677	STBO	Standby action setting	0, 1			
0A80H	42689	TRK1	Whether to select tracking or not	0: OFF 1: ON			
0A90H	42705	PLTS	Palette change method selection	0: PLTn 1: SV 2: PV			
0A92H	42707	F1	User assign key 1 (F1)	0 to 27			
0A94H	42709	F2	User assign key 2 (F2)				
0A96H	42711	F3	User assign key 3 (F3)				
0A98H	42713	JP1	Parameter jump setting 1	1-01 to Z-Z9			Refer to parameter no. setting
0A9AH	42715	JP2	Parameter jump setting 2				
0A9CH	42717	JP3	Parameter jump setting 3				
0AA0H	42721	BRD1	Burnout direction designation (MV1)	0: HOLD 1: LO 2: UP 3: EXMV			
0AE0H	42785	DI01	DI1 function selection	0 to 255			
0AE2H	42787	DI02	DI2 function selection				
0AE4H	42789	DI03	DI3 function selection				
0AE6H	42791	DI04	DI4 function selection				
0AE8H	42793	DI11	DI11 function selection				
0AEAH	42795	DI12	DI12 function selection				
0AECH	42797	DI13	DI13 function selection				
0AEEH	42799	DI14	DI14 function selection				
0AF0H	42801	DI15	DI15 function selection	0 to 255			
0B00H	42817	Ci01	Communication Di1 function setting	0 to 255			
0B02H	42819	Ci02	Communication Di2 function setting				
0B04H	42821	Ci03	Communication Di3 function setting				
0B06H	42823	Ci04	Communication Di4 function setting				
0B08H	42825	Ci05	Communication Di5 function setting				
0B0AH	42827	Ci06	Communication Di6 function setting				
0B0CH	42829	Ci07	Communication Di7 function setting				

Relative address	Register No.	Parameter name	Parameter contents	Read-out data	Write-in data setting range	Affected by input range	Remarks or corresponding parameter
0B0EH	42831	Ci08	Communication Di8 function setting				
0B24H	42853	dSPT	Operation display type	0: Control output (MV) 1: Valve aperture feedback value (MVRB)			
0B26H	42855	odSP	Operation display setting	000 to 111 1: Show, 0: Hide 0-bit: PV/totalized value 1-bit: Value during totalizer/totalized value 2-bit: PV/AiM			
0B30H	42865	brG1	Bar graph display type	NON (0): No display MV (1): Control output MVRB (2): Valve aperture feedback value			
0B50H	42897	DS00	Parameter mask 00	0 to 65535 (0000H to FFFFH)			
0B52H	42899	DS01	Parameter mask 01				
0B54H	42901	DS02	Parameter mask 02				
0B56H	42903	DS03	Parameter mask 03				
0B58H	42905	DS04	Parameter mask 04				
0B5AH	42907	DS05	Parameter mask 05				
0B5CH	42909	DS06	Parameter mask 06				
0B5EH	42911	DS07	Parameter mask 07				
0B60H	42913	DS08	Parameter mask 08	0 to 65535 (0000H to FFFFH)			
0B62H	42915	DS09	Parameter mask 09				
0B64H	42917	DS10	Parameter mask 10				
0B66H	42919	DS11	Parameter mask 11				
0B68H	42921	DS12	Parameter mask 12				
0B6AH	42923	DS13	Parameter mask 13				
0B6CH	42925	DS14	Parameter mask 14				
0B6EH	42927	DS15	Parameter mask 15				
0B70H	42929	DS16	Parameter mask 16	0 to 65535 (0000H to FFFFH)			
0B72H	42931	DS17	Parameter mask 17				
0B74H	42933	DS18	Parameter mask 18				
0B76H	42935	DS19	Parameter mask 19				
0B78H	42937	DS20	Parameter mask 20				
0B7AH	42939	DS21	Parameter mask 21				
0B7CH	42941	DS22	Parameter mask 22				
0B7EH	42943	DS23	Parameter mask 23				
0B80H	42945	DS24	Parameter mask 24	0 to 65535 (0000H to FFFFH)			
0B82H	42947	DS25	Parameter mask 25				
0B84H	42949	DS26	Parameter mask 26				
0B86H	42951	DS27	Parameter mask 27				
0B88H	42953	DS28	Parameter mask 28				
0B8AH	42955	DS29	Parameter mask 29				
0B8CH	42957	DS30	Parameter mask 30				
0B8EH	42959	DS31	Parameter mask 31				
0B90H	42961	DS32	Parameter mask 32	0 to 65535 (0000H to FFFFH)			
0B92H	42963	DS33	Parameter mask 33				
0B94H	42965	DS34	Parameter mask 34				
0B96H	42967	DS35	Parameter mask 35				
0B98H	42969	DS36	Parameter mask 36				
0B9AH	42971	DS37	Parameter mask 37				
0B9CH	42973	DS38	Parameter mask 38				
0B9EH	42975	DS39	Parameter mask 39				
0BA0H	42977	DS40	Parameter mask 40	0 to 65535 (0000H to FFFFH)			
0BA2H	42979	DS41	Parameter mask 41				
0BA4H	42981	DS42	Parameter mask 42				
0BA6H	42983	DS43	Parameter mask 43				
0BA8H	42985	DS44	Parameter mask 44				
0C00H	43073	PAS1	Security setting 1	0 to 65535 (0000H to FFFFH)			
0C02H	43075	PAS2	Security setting 2				
0C04H	43077	PAS3	Security setting 3				

Relative address	Register No.	Parameter name	Parameter contents	Read-out data	Write-in data setting range	Affected by input range	Remarks or corresponding parameter
0C22H	43107	STN4	RS-485 station No.	0 to 255			Turn off and on power
0C24H	43109	SPD4	RS-485 communication speed	0: 9.6k 1: 19.2k 2: 38.4k			
0C26H	43111	BIT4	RS-485 bit format	0: 8N 1: 8O 2: 8E			
0C30H	43121	SPD2	RS-232C communication speed	0: 9.6k 1: 19.2k 2: 38.4k			
0C32H	43123	BIT2	RS-232C bit format	0: 8N 1: 8O 2: 8E			
0C50H	43153	-	FIX command	0: Not writing in memory 1: Now writing in memory	0: No effect 1: Write-in request		
0C80H	43201	P1X0	Linearize table P1X0	-25% to 125% FS (Engineering value of PV1 scale)			
0C82H	43203	P1X1	Linearize table P1X1				
0C84H	43205	P1X2	Linearize table P1X2				
0C86H	43207	P1X3	Linearize table P1X3				
0C88H	43209	P1X4	Linearize table P1X4				
0C8AH	43211	P1X5	Linearize table P1X5				
0C8CH	43213	P1X6	Linearize table P1X6				
0C8EH	43215	P1X7	Linearize table P1X7				
0C90H	43217	P1X8	Linearize table P1X8	-25% to 125% FS (Engineering value of PV1 scale)			
0C92H	43219	P1X9	Linearize table P1X9				
0C94H	43221	P1XA	Linearize table P1XA				
0C96H	43223	P1XB	Linearize table P1XB				
0C98H	43225	P1XC	Linearize table P1XC				
0C9AH	43227	P1XD	Linearize table P1XD				
0C9CH	43229	P1XE	Linearize table P1XE				
0C9EH	43231	P1XF	Linearize table P1XF				
0CA0H	43233	P1Y0	Linearize table P1Y0	-25% to 125% FS (Engineering value of PV1 scale)			
0CA2H	43235	P1Y1	Linearize table P1Y1				
0CA4H	43237	P1Y2	Linearize table P1Y2				
0CA6H	43239	P1Y3	Linearize table P1Y3				
0CA8H	43241	P1Y4	Linearize table P1Y4				
0CAAH	43243	P1Y5	Linearize table P1Y5				
0CACH	43245	P1Y6	Linearize table P1Y6				
0CAEH	43247	P1Y7	Linearize table P1Y7				
0CB0H	43249	P1Y8	Linearize table P1Y8	-25% to 125% FS (Engineering value of PV1 scale)			
0CB2H	43251	P1Y9	Linearize table P1Y9				
0CB4H	43253	P1YA	Linearize table P1YA				
0CB6H	43255	P1YB	Linearize table P1YB				
0CB8H	43257	P1YC	Linearize table P1YC				
0CBAH	43259	P1YD	Linearize table P1YD				
0CBCH	43261	P1YE	Linearize table P1YE				
0CBEH	43263	P1YF	Linearize table P1YF				
0CC0H	43265	P2X0	Linearize table P2X0	-25% to 125% FS (Engineering value of PV2 scale)			
0CC2H	43267	P2X1	Linearize table P2X1				
0CC4H	43269	P2X2	Linearize table P2X2				
0CC6H	43271	P2X3	Linearize table P2X3				
0CC8H	43273	P2X4	Linearize table P2X4				
0CCAH	43275	P2X5	Linearize table P2X5				
0CCCH	43277	P2X6	Linearize table P2X6				
0CCEH	43279	P2X7	Linearize table P2X7				
0CD0H	43281	P2X8	Linearize table P2X8	-25% to 125% FS (Engineering value of PV2 scale)			
0CD2H	43283	P2X9	Linearize table P2X9				

Relative address	Register No.	Parameter name	Parameter contents	Read-out data	Write-in data setting range	Affected by input range	Remarks or corresponding parameter
0CD4H	43285	P2XA	Linearize table P2XA	-25% to 125% FS (Engineering value of PV2 scale)			
0CD6H	43287	P2XB	Linearize table P2XB				
0CD8H	43289	P2XC	Linearize table P2XC				
0CDAH	43291	P2XD	Linearize table P2XD				
0CDCH	43293	P2XE	Linearize table P2XE				
0CDEH	43295	P2XF	Linearize table P2XF				
0CE0H	43297	P2Y0	Linearize table P2Y0	-25% to 125% FS (Engineering value of PV2 scale)			
0CE2H	43299	P2Y1	Linearize table P2Y1				
0CE4H	43301	P2Y2	Linearize table P2Y2				
0CE6H	43303	P2Y3	Linearize table P2Y3				
0CE8H	43305	P2Y4	Linearize table P2Y4				
0CEAH	43307	P2Y5	Linearize table P2Y5				
0CECH	43309	P2Y6	Linearize table P2Y6				
0CEEH	43311	P2Y7	Linearize table P2Y7				
0CF0H	43313	P2Y8	Linearize table P2Y8	-25% to 125% FS (Engineering value of PV2 scale)			
0CF2H	43315	P2Y9	Linearize table P2Y9				
0CF4H	43317	P2YA	Linearize table P2YA				
0CF6H	43319	P2YB	Linearize table P2YB				
0CF8H	43321	P2YC	Linearize table P2YC				
0CFAH	43323	P2YD	Linearize table P2YD				
0CFCH	43325	P2YE	Linearize table P2YE				
0CFEH	43327	P2YF	Linearize table P2YF				
0D40H	43393	A1X0	Linearize table A1X0	-25% to 125% FS (Engineering value of Ai1 scale)			
0D42H	43395	A1X1	Linearize table A1X1				
0D44H	43397	A1X2	Linearize table A1X2				
0D46H	43399	A1X3	Linearize table A1X3				
0D48H	43401	A1X4	Linearize table A1X4				
0D4AH	43403	A1X5	Linearize table A1X5				
0D4CH	43405	A1X6	Linearize table A1X6				
0D4EH	43407	A1X7	Linearize table A1X7				
0D50H	43409	A1X8	Linearize table A1X8	-25% to 125% FS (Engineering value of Ai1 scale)			
0D52H	43411	A1X9	Linearize table A1X9				
0D54H	43413	A1XA	Linearize table A1XA				
0D56H	43415	A1XB	Linearize table A1XB				
0D58H	43417	A1XC	Linearize table A1XC				
0D5AH	43419	A1XD	Linearize table A1XD				
0D5CH	43421	A1XE	Linearize table A1XE				
0D5EH	43423	A1XF	Linearize table A1XF				
0D60H	43425	A1Y0	Linearize table A1Y0	-25% to 125% FS (Engineering value of Ai1 scale)			
0D62H	43427	A1Y1	Linearize table A1Y1				
0D64H	43429	A1Y2	Linearize table A1Y2				
0D66H	43431	A1Y3	Linearize table A1Y3				
0D68H	43433	A1Y4	Linearize table A1Y4				
0D6AH	43435	A1Y5	Linearize table A1Y5				
0D6CH	43437	A1Y6	Linearize table A1Y6				
0D6EH	43439	A1Y7	Linearize table A1Y7				
0D70H	43441	A1Y8	Linearize table A1Y8	-25% to 125% FS (Engineering value of Ai1 scale)			
0D72H	43443	A1Y9	Linearize table A1Y9				
0D74H	43445	A1YA	Linearize table A1YA				
0D76H	43447	A1YB	Linearize table A1YB				
0D78H	43449	A1YC	Linearize table A1YC				
0D7AH	43451	A1YD	Linearize table A1YD				
0D7CH	43453	A1YE	Linearize table A1YE				
0D7EH	43455	A1YF	Linearize table A1YF				

Relative address	Register No.	Parameter name	Parameter contents	Read-out data	Write-in data setting range	Affected by input range	Remarks or corresponding parameter
0DC0H	43521	K01	Mathematical calculation constant 1	Floating decimal point type 99999 to 0.0000 -0.001 to -9999			
0DC2H	43523	K02	Mathematical calculation constant 2				
0DC4H	43525	K03	Mathematical calculation constant 3				
0DC6H	43527	K04	Mathematical calculation constant 4				
0DC8H	43529	K05	Mathematical calculation constant 5				
0DCAH	43531	K06	Mathematical calculation constant 6				
0DCCH	43533	K07	Mathematical calculation constant 7				
0DCEH	43535	K08	Mathematical calculation constant 8				
0DD0H	43537	K09	Mathematical calculation constant 9	Floating decimal point type 99999 to 0.0000 -0.001 to -9999			
0DD2H	43539	K10	Mathematical calculation constant 10				
0DD4H	43541	K11	Mathematical calculation constant 11				
0DD6H	43543	K12	Mathematical calculation constant 12				
0DD8H	43545	K13	Mathematical calculation constant 13				
0DDAH	43547	K14	Mathematical calculation constant 14				
0DDCH	43549	K15	Mathematical calculation constant 15				
0DDEH	43551	K16	Mathematical calculation constant 16				
0E00H	43585	ATP1	Auto tuning type	0: NRML 1: LPV			
0E20H	43617	DO1	DO1 output designation	0 to 255			Turn off and on power
0E22H	43619	DO2	DO2 output designation				
0E24H	43621	DO3	DO3 output designation				
0E26H	43623	DO4	DO4 output designation				
0E30H	43633	DO11	DO11 output designation	0 to 255			
0E32H	43635	DO12	DO12 output designation				
0E34H	43637	DO13	DO13 output designation				
0E36H	43639	DO14	DO14 output designation				
0E38H	43641	DO15	DO15 output designation				
0E70H	43697	C1	LED C1 assign				0 to 255
0E72H	43699	C2	LED C2 assign				
0E74H	43701	LDO1	LED DO1 assign				
0E76H	43703	LDO2	LED DO2 assign				
0E78H	43705	LDO3	LED DO3 assign				
0E7AH	43707	LDO4	LED DO4 assign				
0E7CH	43709	LDO5	LED DO5 assign				
0E7EH	43711	LALM	LED ALM assign				
0EA0H	43745	CN01	Constant 1 used for template	-19999 to 99999			
0EA2H	43747	CN02	Constant 2 used for template				
0EA4H	43749	CN03	Constant 3 used for template				
0EA6H	43751	CN04	Constant 4 used for template				
0EA8H	43753	CN05	Constant 5 used for template				
0EAAH	43755	CN06	Constant 6 used for template				
0EACH	43757	CN07	Constant 7 used for template				
0EAEH	43759	CN08	Constant 8 used for template				



Relative address	Register No.	Parameter name	Parameter contents	Read-out data	Write-in data setting range	Affected by input range	Remarks or corresponding parameter
0EB0H	43761	CN09	Constant 9 used for template	-19999 to 99999			
0EB2H	43763	CN10	Constant 10 used for template				
0EB4H	43765	CN11	Constant 11 used for template				
0EB6H	43767	CN12	Constant 12 used for template				
0EB8H	43769	CN13	Constant 13 used for template				
0EBAH	43771	CN14	Constant 14 used for template				
0EBCH	43773	CN15	Constant 15 used for template				
0EBEH	43775	CN16	Constant 16 used for template				
0F00H	43841	TrUn	Totalizer command/status	hoLd/rUn/LATCh			
0F02H	43843	TrES	Totalizer reset command	on/oFF			
0F04H	43845	Toin	Totalizer input selection	(0) Pv1 (1) Pv2 (2) Ai1 (3) AiM * When "(3) AiM" is selected, set the mathematical calculation scale to (Ch 8-89, 90, 91).			
0F06H	43847	TdP	Totalizer value display decimal point position	0 to 4			
0F08H	43849	TCUT	Totalizer cut point	0% to 100%FS (Engineering value setting) Decimal point position for the input scale set in Toin depends on decimal point setting for input range.			
0F0AH	43851	A1TP	Totalizer alarm 1 type	0: No alarm 1: Totalizer value alarm 2: Totalizer batch output 3: Totalizer batch output (with auto-reset)			
0F0CH	43853	A1on	Totalizer alarm 1 ON pulse width	0: Continuous 1: 100 ms 2: 200 ms 3: 500 ms 4: 1 sec			
0F0EH	43855	A1oP	Totalizer alarm 1 Excitation/non-excitation setting	0: Excitation 1: Non-excitation			
0F10H	43857	A2TP	Totalizer alarm 2 type	0: No alarm 1: Totalizer value alarm 2: Totalizer batch output 3: Totalizer batch output (with auto-reset)			
0F12H	43859	A2on	Totalizer alarm 2 ON pulse width	0: Continuous 1: 100 ms 2: 200 ms 3: 500 ms 4: 1 sec			
0F14H	43861	A2oP	Totalizer alarm 2 Excitation/non-excitation setting	0: Excitation 1: Non-excitation			
0F16H	43863	TMod	Operation mode	(0) JpN: Japanese mode (1) EnG: English mode			
0F18H	43865	ToPT	Totalizer option setting	0000 to 1111			
0F1AH	43867	Tb	Totalizer standard time	(0) SEC (1) Min (2) hoUr (3) dAY			
0F1CH	43869	SCL	Totalizer divisor	0 to ±1000000			
0F1EH	43871	MUL	Totalizer multiplier				
0F20H	43873	TCF	Totalizer constant	20 to 9999999 Uses decimal point set in TdP			
0F22H	43875	TinT	Totalizer initial value	-1999999 to 9999999			
0F24H	43877	A1SP	Totalizer alarm 1 setting	Uses decimal point set in TdP			

Relative address	Register No.	Parameter name	Parameter contents	Read-out data	Write-in data setting range	Affected by input range	Remarks or corresponding parameter
0F26H	43879	A2SP	Totalizer alarm 2 setting	-1999999 to 9999999 Uses decimal point set in TdP			
0F28H	43881	rTSc	Transfer output source scale	-1999999 to 9999999			
0F30H	43889	rCP0	Recipe assignment 1	0-00 to R-Z9		Refer to parameter no. setting	
0F32H	43891	rCP1	Recipe assignment 2				
0F34H	43893	rCP2	Recipe assignment 3				
0F36H	43895	rCP3	Recipe assignment 4				
0F38H	43897	rCP4	Recipe assignment 5				
0F3AH	43899	rCP5	Recipe assignment 6				
0F3CH	43901	rCP6	Recipe assignment 7				
0F3EH	43903	rCP7	Recipe assignment 8				
0F40H	43905	rCP8	Recipe assignment 9	0-00 to R-Z9		Refer to parameter no. setting	
0F42H	43907	rCP9	Recipe assignment 10				
0F44H	43909	d00	Recipe setting 0	Dependent on rCP0 setting			
0F46H	43911	d01	Recipe setting 1	Dependent on rCP1 setting			
0F48H	43913	d02	Recipe setting 2	Dependent on rCP2 setting			
0F4AH	43915	d03	Recipe setting 3	Dependent on rCP3 setting			
0F4CH	43917	d04	Recipe setting 4	Dependent on rCP4 setting			
0F4EH	43919	d05	Recipe setting 5	Dependent on rCP5 setting			
0F50H	43921	d06	Recipe setting 6	Dependent on rCP6 setting			
0F52H	43923	d07	Recipe setting 7	Dependent on rCP7 setting			
0F54H	43925	d08	Recipe setting 8	Dependent on rCP8 setting			
0F56H	43927	d09	Recipe setting 9	Dependent on rCP9 setting			
0F58H	43929	d10	Recipe setting 10	Dependent on rCP0 setting			
0F5AH	43931	d11	Recipe setting 11	Dependent on rCP1 setting			
0F5CH	43933	d12	Recipe setting 12	Dependent on rCP2 setting			
0F5EH	43935	d13	Recipe setting 13	Dependent on rCP3 setting			
0F60H	43937	d14	Recipe setting 14	Dependent on rCP4 setting			
0F62H	43939	d15	Recipe setting 15	Dependent on rCP5 setting			
0F64H	43941	d16	Recipe setting 16	Dependent on rCP6 setting			
0F66H	43943	d17	Recipe setting 17	Dependent on rCP7 setting			
0F68H	43945	d18	Recipe setting 18	Dependent on rCP8 setting			
0F6AH	43947	d19	Recipe setting 19	Dependent on rCP9 setting			
0F6CH	43949	d20	Recipe setting 20	Dependent on rCP0 setting			
0F6EH	43951	d21	Recipe setting 21	Dependent on rCP1 setting			
0F70H	43953	d22	Recipe setting 22	Dependent on rCP2 setting			
0F72H	43955	d23	Recipe setting 23	Dependent on rCP3 setting			
0F74H	43957	d24	Recipe setting 24	Dependent on rCP4 setting			
0F76H	43959	d25	Recipe setting 25	Dependent on rCP5 setting			
0F78H	43961	d26	Recipe setting 26	Dependent on rCP6 setting			
0F7AH	43963	d27	Recipe setting 27	Dependent on rCP7 setting			
0F7CH	43965	d28	Recipe setting 28	Dependent on rCP8 setting			
0F7EH	43967	d29	Recipe setting 29	Dependent on rCP9 setting			
0F80H	43969	d30	Recipe setting 30	Dependent on rCP0 setting			
0F82H	43971	d31	Recipe setting 31	Dependent on rCP1 setting			
0F84H	43973	d32	Recipe setting 32	Dependent on rCP2 setting			
0F86H	43975	d33	Recipe setting 33	Dependent on rCP3 setting			
0F88H	43977	d34	Recipe setting 34	Dependent on rCP4 setting			
0F8AH	43979	d35	Recipe setting 35	Dependent on rCP5 setting			
0F8CH	43981	d36	Recipe setting 36	Dependent on rCP6 setting			
0F8EH	43983	d37	Recipe setting 37	Dependent on rCP7 setting			
0F90H	43985	d38	Recipe setting 38	Dependent on rCP8 setting			
0F92H	43987	d39	Recipe setting 39	Dependent on rCP9 setting			
0F94H	43989	d40	Recipe setting 40	Dependent on rCP0 setting			
0F96H	43991	d41	Recipe setting 41	Dependent on rCP1 setting			
0F98H	43993	d42	Recipe setting 42	Dependent on rCP2 setting			
0F9AH	43995	d43	Recipe setting 43	Dependent on rCP3 setting			
0F9CH	43997	d44	Recipe setting 44	Dependent on rCP4 setting			
0F9EH	43999	d45	Recipe setting 45	Dependent on rCP5 setting			
0FA0H	44001	d46	Recipe setting 46	Dependent on rCP6 setting			
0FA2H	44003	d47	Recipe setting 47	Dependent on rCP7 setting			
0FA4H	44005	d48	Recipe setting 48	Dependent on rCP8 setting			
0FA6H	44007	d49	Recipe setting 49	Dependent on rCP9 setting			
0FA8H	44009	d50	Recipe setting 50	Dependent on rCP0 setting			
0FAAH	44011	d51	Recipe setting 51	Dependent on rCP1 setting			
0FACH	44013	d52	Recipe setting 52	Dependent on rCP2 setting			

Relative address	Register No.	Parameter name	Parameter contents	Read-out data	Write-in data setting range	Affected by input range	Remarks or corresponding parameter
0FAEH	44015	d53	Recipe setting 53	Dependent on rCP3 setting			
0FB0H	44017	d54	Recipe setting 54	Dependent on rCP4 setting			
0FB2H	44019	d55	Recipe setting 55	Dependent on rCP5 setting			
0FB4H	44021	d56	Recipe setting 56	Dependent on rCP6 setting			
0FB6H	44023	d57	Recipe setting 57	Dependent on rCP7 setting			
0FB8H	44025	d58	Recipe setting 58	Dependent on rCP8 setting			
0FBAH	44027	d59	Recipe setting 59	Dependent on rCP9 setting			
0FBCH	44029	d60	Recipe setting 60	Dependent on rCP0 setting			
0FBEH	44031	d61	Recipe setting 61	Dependent on rCP1 setting			
0FC0H	44033	d62	Recipe setting 62	Dependent on rCP2 setting			
0FC2H	44035	d63	Recipe setting 63	Dependent on rCP3 setting			
0FC4H	44037	d64	Recipe setting 64	Dependent on rCP4 setting			
0FC6H	44039	d65	Recipe setting 65	Dependent on rCP5 setting			
0FC8H	44041	d66	Recipe setting 66	Dependent on rCP6 setting			
0FCAH	44043	d67	Recipe setting 67	Dependent on rCP7 setting			
0FCCH	44045	d68	Recipe setting 68	Dependent on rCP8 setting			
0FCEH	44047	d69	Recipe setting 69	Dependent on rCP9 setting			
0FD0H	44049	d70	Recipe setting 70	Dependent on rCP0 setting			
0FD2H	44051	d71	Recipe setting 71	Dependent on rCP1 setting			
0FD4H	44053	d72	Recipe setting 72	Dependent on rCP2 setting			
0FD6H	44055	d73	Recipe setting 73	Dependent on rCP3 setting			
0FD8H	44057	d74	Recipe setting 74	Dependent on rCP4 setting			
0FDAH	44059	d75	Recipe setting 75	Dependent on rCP5 setting			
0FDCH	44061	d76	Recipe setting 76	Dependent on rCP6 setting			
0FDEH	44063	d77	Recipe setting 77	Dependent on rCP7 setting			
0FEOH	44065	d78	Recipe setting 78	Dependent on rCP8 setting			
0FE2H	44067	d79	Recipe setting 79	Dependent on rCP9 setting			
01388H	45001		Communication Di terminal	00000000 to 11111111 (8-bit)			

Word data [read-out only] : Function code [04<sub>H</sub>]

Relative address	Register No.	Parameter name	Parameter contents	Read-out data	Affected by input range	Remarks or corresponding parameter
0100H	30257	PID MODE1	Current control mode	0001H: Fault status 0002H: Standby status 0004H: Remote Ack 0008H: Other than auto mode 0010H: Auto mode request 0020H: Remote mode request 0040H: Auto tuning status 0080H: Normal operation status 0100H: PV tracking status 0200H: Local SV status 0400H: Remote SV status 0800H: Local + PV tracking status 1000H: Forced manual mode status 2000H: EX-MV mode status 4000H: Manual mode status		Corresponding bit to relevant status is "1".
0102H	30259	PV1	Process variable (PV) used for control currently	-25999 to 105999 (Input scale: -5 to 105% FS)	*	
0104H	30261	SV1	Currently used setpoint (SV)	-19999 to 99999 (within settable range)	*	
0106H	30263	DV1	Currently used deviation (DV)	-125998 to 125998 (Input scale: -105 to 105% FS)	*	
0108H	30265	MV1	Currently used manipulating value (MV)	-250 to 1250 (-25.0 to 125.0%)		
010CH	30269	FAULT1	Currently used input error status information	Normal: 0 Over: 1 Under: 2		
0270H	30625	HMV1	Heating MV	—		
0272H	30627	HMV2		—		
0280H	30641	CMV1	Cooling MV	—		
0282H	30643	CMV2		—		
0310H	30785	ALM1 (RELAY)	Alarm 1 status (relay status)	Excitation: 1, Non-excitation: 0		
0312H	30787	ALM2 (RELAY)	Alarm 2 status (relay status)			
0314H	30789	ALM3 (RELAY)	Alarm 3 status (relay status)			
0316H	30791	ALM4 (RELAY)	Alarm 4 status (relay status)			
0318H	30793	ALM5 (RELAY)	Alarm 5 status (relay status)			
031AH	30795	ALM6 (RELAY)	Alarm 6 status (relay status)			
031CH	30797	ALM7 (RELAY)	Alarm 7 status (relay status)			
031EH	30799	ALM8 (RELAY)	Alarm 8 status (relay status)			
0340H	30833	ALM1	Alarm 1 status	ON: 1, OFF: 0		
0342H	30835	ALM2	Alarm 2 status			
0344H	30837	ALM3	Alarm 3 status			
0346H	30839	ALM4	Alarm 4 status			
0348H	30841	ALM5	Alarm 5 status			
034AH	30843	ALM6	Alarm 6 status			
034CH	30845	ALM7	Alarm 7 status			
034EH	30847	ALM8	Alarm 8 status			
03C0H	30961	STAT	Display of Ramp/soak activation	oFF : Ramp/soak is stopped 1-rP : Step1 during ramp 1-Sk : Step1 during soak ... 64rP : Step64 during ramp 64Sk : Step64 during soak End : Ramp/soak end		
03C2H	30963	rSTM	Ramp/soak elapsed time	0~5999 (min/sec)		
03C4H	30965	PTno	Current pattern No.	0~30		
03C6H	30967	DiPT	Current pattern No. selected by DI	0~30		

Relative address	Register No.	Parameter name	Parameter contents	Read-out data	Affected by input range	Remarks or corresponding parameter
03C8H	30969	rSV	Display the SV value which is result from Ramp/soak calculation	0~100%FS	*	
0400H	31025	PV1	PV1 measurement value	-214783647 to 214783648	*	
0402H	31027	PV2	PV2 measurement value		*	
0406H	31031	AI1	Ai1 measurement value		*	
0420H	31057	RCJ1	PV1 RCJ measurement value			
0422H	31059	RCJ2	PV2 RCJ measurement value			
0450H	31105	AO1	AO1 output value	-250 to 1250 (-25.0 to 125.0%)		
0452H	31107	AO2	AO2 output value			
0470H	31137	DI01	DI1 to 4 input status	DI1: 8000H DI2: 4000H DI3: 2000H DI4: 1000H		Corresponding bit to ON is "1".
0472H	31139	DI11	DI11 to 15 input status	DI11: 8000H DI12: 4000H DI13: 2000H DI14: 1000H DI15: 0800H		Corresponding bit to ON is "1".
0476H	31143	diC1	Communication Di monitor (1-5)	—		
0478H	31145	diC2	Communication Di monitor (6-8)	—		
04D0H	31233	DO01	DO1 to 4 output status	DO1: 1 DO2: 2 DO3: 4 DO4: 8		Corresponding bit to ON is "1".
04D2H	31235	DO11	DO11 to 15 output status	DO11: 1 DO12: 2 DO13: 4 DO14: 8 DO15: 16		Corresponding bit to ON is "1".
0540H	31345	AIM	Mathematical calculation result	-214783647 to 214783648	*	Mathematical calculation scale
0550H	31361	ALM DLY 1	Alarm 1 delay timer remaining time monitor	0 to 9999		
0552H	31363	ALM DLY 2	Alarm 2 delay timer remaining time monitor			
0554H	31365	ALM DLY 3	Alarm 3 delay timer remaining time monitor			
0556H	31367	ALM DLY 4	Alarm 4 delay timer remaining time monitor			
0558H	31369	ALM DLY 5	Alarm 5 delay timer remaining time monitor			
055AH	31371	ALM DLY 6	Alarm 6 delay timer remaining time monitor			
055CH	31373	ALM DLY 7	Alarm 7 delay timer remaining time monitor			
055EH	31375	ALM DLY 8	Alarm 8 delay timer remaining time monitor			
0564H	31381	AMV1	EXMV value (External analog value)	-214783647 to 214783648		
056CH	31389	FFV1	Feed Forward value	-214783647 to 214783648		
0574H	31397	MVrb	Valve aperture monitor	-50 to 1050 (-5.0% to 105.0%)		
0576H	31399	Int Val	Front integration display			
0578H	31401		Totalizer alarm 1 status (relay state)	Excitation: 1, Non-excitation: 0		
057AH	31403		Totalizer alarm 2 status (relay state)			
057CH	31405		Totalizer alarm 1 status	ON: 1, OFF: 0		
057EH	31407		Totalizer alarm 2 status			

## 8. SAMPLE PROGRAM

---

This section concerns data read-out/write-in sample program by Microsoft Visual Basic 6.0 (SP6).

Note that the program shown here is for reference for you to create a program and not for guaranteeing all actions.

Before executing the program, make sure of the communication conditions in the following procedure.

- Parity, communication speed: Must be set in this program to match the instrument.

Precautions for some RS-232C  $\Leftrightarrow$  RS-485 converter

The transmission data itself may precede the answer data from the slave station. In such a case, discard as many data as transmission bytes found there, and then process it as answer data.

Applicable OS

Windows 2000 Professional

Windows XP Professional Edition

Fuji Electric Systems Co., Ltd. will not be responsible for damages attributable to use of the sample program nor infringement of rights owned by third parties.

Use the program upon admitting the above.

---

(a) Example of data read-out

Operation: 2 word data of a designated address is read-out and displayed at a time.

Used function code: 03<sub>H</sub> , 04<sub>H</sub>

Read-out word number: 2

```
' Variable declaration *****
  Dim idx As Integer
  Dim Ansdatt() As Byte
  Dim Rxbuff As Variant
  Dim PauseTime
  Dim Stno As Byte
  ' For storing answer data
  ' Receive data buffer
  ' Sets the communication wait time
  ' Required wait time depends on transmission speed and transmission frame length
  ' Communication station number

Private Sub Form_Load()

' Initializing the variable *****
  Stno = 1
  Main.Visible = True

End Sub

'-----
'Read continuous words sample program
'Function code : 03H, 04H
'Number of words : 2
'-----

Private Sub TX1_Click()

  TX1.Enabled = False

' Communication port setting *****
  If Com5.Value = True Then
    Comm_port = 5
    ' COM5
  ElseIf Com4.Value = True Then
    Comm_port = 4
    ' COM4
  ElseIf Com3.Value = True Then
    Comm_port = 3
    ' COM3
  ElseIf Com2.Value = True Then
    Comm_port = 2
    ' COM2
  Else
    Comm_port = 1
    ' COM1
  End If

  If SPD192.Value = True Then
    Comm_speed = "19200,"
    ' 19200bps
  ElseIf SPD96.Value = True Then
    Comm_speed = "9600,"
    ' 9600bps
  Else
    Comm_speed = "38400,"
    ' 38400bps
  End If

  If Even1.Value = True Then
    Comm_parity = "E,"
    ' Even parity
  ElseIf Odd1.Value = True Then
    Comm_parity = "O,"
    ' Odd parity
  Else
    Comm_parity = "N,"
    ' No parity
  End If

  PauseTime = 0.2
    ' Sets the wait time (0.2 sec)

  idx = 0

' Opening the communication port *****
  MSCComm1.CommPort = Comm_port
  MSCComm1.Settings = Comm_speed & Comm_parity & "8,1"
  MSCComm1.PortOpen = True
  ' COM port setting
  ' Speed / Parity / 8bit_Data / Stop_1bit
  ' Opens a port

' Setting the opposite station number for communication *****
  St = Val(Stno1(idx).Text)
  Stno = St Mod 256
  Stno1(idx).Text = Str(Stno)

' Address processing *****
  ADS = Str(Val(Address(idx).Text) - 1)
  ADS = Right$("00000" & ADS, 5)
  Area = Val(Left$(ADS, 1))
  Adrsh = Int(Val(Right$(ADS, 4)) / 256)
  Adrsl = Val(Right$(ADS, 4)) Mod 256
```

```

' Transmission command generation *****
Select Case Area
Case 3
  ReDim Txdat(7) As Byte          ' Secures 8 byte array
  Txdat(0) = Stno                ' Station No.
  Txdat(1) = &H4                 ' Command
  Txdat(2) = Adrsh               ' High address
  Txdat(3) = Adrsl               ' Low address
  Txdat(4) = &H0                 ' Number of read-in words (High)
  Txdat(5) = &H2                 ' Number of read-in words (Low)
  Txsu = 5                       ' Number of transmission data

Case 4
  ReDim Txdat(7) As Byte          ' Secures 8 byte array
  Txdat(0) = Stno                ' Station No.
  Txdat(1) = &H3                 ' Command
  Txdat(2) = Adrsh               ' High address
  Txdat(3) = Adrsl               ' Low address
  Txdat(4) = &H0                 ' Number of read-in words (High)
  Txdat(5) = &H2                 ' Number of read-in words (Lo)
  Txsu = 5                       ' Number of transmission data

Case Else
  ' For other value
  MSComm1.PortOpen = False      ' Closes COM port
  TX1.Enabled = True
  Exit Sub
End Select

' Transmitting a command *****

' Generation of CRC for transmission data
GoSub 10000                      ' CRC calculation
Txdat(Txsu + 1) = CRC1
Txdat(Txsu + 2) = CRC2

' Transmitting a generated command
MSComm1.Output = Txdat          ' Transmits 1 byte

' Waiting until all answer data is received
Start = Timer                    ' Saves the waiting start time
Do While Timer < Start + PauseTime ' Whether time setting elapsed
  DoEvents                       ' Transfers the control to another process
  If ((Start + PauseTime) - Timer) > PauseTime Then
    Start = Timer
  End If
Loop

' Fetching the answer data into byte array
MSComm1.InputMode = comInputModeBinary ' Designates binary mode
length = MSComm1.InBufferCount        ' Acquires required number of receive data bytes
MSComm1.InputLen = 0                   ' Designates acquisition of all data
Rxbuff = MSComm1.Input                 ' Fetches receive data into receive buffer
Ansdatt = Rxbuff                       ' Assigns byte array to receive data

' CRC calculation for receive data
Ansu = length - 3                      ' Receive data length
GoSub 20000                             ' CRC calculation

' Error check
If (length = 0) Then                   ' No answer
  Noans = Noans + 1: Rx_data.Caption = "Noans": GoTo 150
ElseIf ((Ansdatt(length - 2) <> CRC1) + (Ansdatt(length - 1) <> CRC2)) Then ' CRC error
  CRCErr = CRCErr + 1: Rx_data.Caption = "CRCErr": GoTo 150
ElseIf Ansdatt(1) >= &H80 Then         ' Command error
  CMDErr = CMDErr + 1: Rx_data.Caption = "CMDErr": GoTo 150
End If

' Processing of normal receive data
wrk1 = Ansdatt(3)
wrk2 = Ansdatt(4)
wrk3 = Ansdatt(5)
wrk4 = Ansdatt(6)
If Ansdatt(5) > 128 Then                ' If receive data is negative
  Rx_data.Caption = Str(((wrk3 * (2 ^ 24)) + (wrk4 * (2 ^ 16)) + (wrk1 * (2 ^ 8)) + wrk2) - (2 ^ 32))
Else
  Rx_data.Caption = Str(((wrk3 * (2 ^ 24)) + (wrk4 * (2 ^ 16)) + (wrk1 * (2 ^ 8)) + wrk2))
End If
150
MSComm1.PortOpen = False                ' Closes COM port

TX1.Enabled = True

Exit Sub

```



---

```

' *****
10000 ' CRC calculation subroutine IN:Txdat(Txsu) / OUT CRC1,CRC2 *****
CRC = &HFFFF
For i = 0 To Txsu Step 1
  CRC = CRC Xor Txdat(i)
  For J = 1 To 8 Step 1
    CT = CRC And &H1
    If CRC < 0 Then CH = 1 Else: CH = 0: GoTo 11000
    CRC = CRC And &H7FFF
11000   CRC = Int(CRC / 2)
    If CH = 1 Then CRC = CRC Or &H4000
    If CT = 1 Then CRC = CRC Xor &HA001
  Next J
Next i
CRC1 = CRC And &HFF
CRC2 = ((CRC And &HFF00) / 256 And &HFF)
Return

20000 ' CRC calculation subroutine IN:Ansdat(Ansu) / OUT CRC1,CRC2 *****
CRC = &HFFFF
For i = 0 To Ansu Step 1
  CRC = CRC Xor Ansdat(i)
  For J = 1 To 8 Step 1
    CT = CRC And &H1
    If CRC < 0 Then CH = 1 Else: CH = 0: GoTo 21000
    CRC = CRC And &H7FFF
21000   CRC = Int(CRC / 2)
    If CH = 1 Then CRC = CRC Or &H4000
    If CT = 1 Then CRC = CRC Xor &HA001
  Next J
Next i
CRC1 = CRC And &HFF
CRC2 = ((CRC And &HFF00) / 256 And &HFF)
Return

End Sub

```

---

(b) Example of data write-in

Operation: Writes 2 word data into a designated address

Used function code: 10<sub>H</sub>

Number of write-in words: 2

```
'-----  
'Write 2 words sample program  
'Function code : 10H  
'Number of words : 2  
'-----  
  
Private Sub Write_command_Click()  
    Write_command.Enabled = False  
  
    ' Communication port setting *****  
    If Com5.Value = True Then  
        Comm_port = 5                ' COM5  
    ElseIf Com4.Value = True Then  
        Comm_port = 4                ' COM4  
    ElseIf Com3.Value = True Then  
        Comm_port = 3                ' COM3  
    ElseIf Com2.Value = True Then  
        Comm_port = 2                ' COM2  
    Else  
        Comm_port = 1                ' COM1  
    End If  
  
    If SPD192.Value = True Then  
        Comm_speed = "19200,"        ' 19200bps  
    ElseIf SPD96.Value = True Then  
        Comm_speed = "9600,"        ' 9600bps  
    Else  
        Comm_speed = "38400,"       ' 38400bps  
    End If  
  
    If Even1.Value = True Then  
        Comm_parity = "E,"          ' Even parity  
    ElseIf Odd1.Value = True Then  
        Comm_parity = "O,"          ' Odd parity  
    Else  
        Comm_parity = "N,"          ' No parity  
    End If  
  
    PauseTime = 0.2                  ' Sets the wait time (0.2 sec)  
    idx = 1  
  
    ' Opening the communication port *****  
    MSComm1.CommPort = Comm_port    ' Com port  
    MSComm1.Settings = Comm_speed & Comm_parity & "8,1" ' Speed / Parity / 8bit_Data / Stop_1bit  
    MSComm1.PortOpen = True         ' Open com port  
  
    ' Setting the opposite station number for communication *****  
    St = Val(Stno1(idx).Text)  
    Stno = St Mod 256  
    Stno1(idx).Text = Str(Stno)  
  
    ' Address processing *****  
    ADS = Str(Val(Address(idx).Text) - 1)  
    ADS = Right$("00000" & ADS, 5)  
    Area = Val(Left$(ADS, 1))  
    Adrsh = Int(Val(Right$(ADS, 4)) / 256)  
    Adrsl = Val(Right$(ADS, 4)) Mod 256  
  
    ' Transmission command generation *****  
  
    Select Case Area  
    Case 4  
  
        'Normal sending data is processed.  
        Dim byteData(3) As Byte  
        Dim sHex As String  
  
        sHex = Right$("00000000" & Hex(Val(Write_data.Text)), 8) ' Decimal → hexadecimal  
        byteData(0) = CByte("&H" & Mid(sHex, 1, 2))           'hh byte  
        byteData(1) = CByte("&H" & Mid(sHex, 3, 2))           'hl byte  
        byteData(2) = CByte("&H" & Mid(sHex, 5, 2))           'lh byte  
        byteData(3) = CByte("&H" & Mid(sHex, 7, 2))           'll byte
```

```

ReDim Txdat(12) As Byte          ' 13 bytes
Txdat(0) = Sino                 ' Station No.
Txdat(1) = &H10                 ' Command
Txdat(2) = Adrsh                ' High address
Txdat(3) = Adrsl                ' Low address
Txdat(4) = &H0                  ' Number of write-in words (High)
Txdat(5) = &H2                  ' Number of write -in words (Lo)
Txdat(6) = &H4                  ' Number of write -in bytes
Txdat(7) = byteData(2)         ' Write-in data (Lo high)
Txdat(8) = byteData(3)         ' Write-in data (Lo lo)
Txdat(9) = byteData(0)         ' Write-in data (High high)
Txdat(10) = byteData(1)        ' Write-in data (High lo)
Txsu = 10                      ' Number of transmission data

Case Else                       ' For other
    MSCComm1.PortOpen = False   ' Closes COM port
    Write_command.Enabled = True
    Exit Sub
End Select

' Transmitting a command *****

' Generation of CRC for transmission data
GoSub 10000                     ' CRC calculation
Txdat(Txsu + 1) = CRC1          '
Txdat(Txsu + 2) = CRC2          '

' Transmitting a generated command
MSCComm1.Output = Txdat        ' Transmits 1 byte

' Waiting until all answer data is received
Start = Timer                   ' Saves the waiting start time
Do While Timer < Start + PauseTime ' Whether time setting elapsed
    DoEvents                    ' Transfers the control to another process
    If ((Start + PauseTime) - Timer) > PauseTime Then
        Start = Timer
    End If
Loop

MSCComm1.PortOpen = False      ' Closes COM port

Write_command.Enabled = True

Exit Sub

*****

10000 ' CRC calculation subroutine IN:Txdat(Txsu) / OUT CRC1,CRC2 *****
CRC = &HFFFF
For i = 0 To Txsu Step 1
    CRC = CRC Xor Txdat(i)
    For J = 1 To 8 Step 1
        CT = CRC And &H1
        If CRC < 0 Then CH = 1 Else: CH = 0: GoTo 11000
        CRC = CRC And &H7FFF
11000    CRC = Int(CRC / 2)
        If CH = 1 Then CRC = CRC Or &H4000
        If CT = 1 Then CRC = CRC Xor &HA001
    Next J
Next i
CRC1 = CRC And &HFF
CRC2 = ((CRC And &HFF00) / 256 And &HFF)
Return

End Sub

```

## 9. TROUBLESHOOTING

---

If the communication is unavailable, check the following items.

- Whether all devices related to communication are turned on.
- Whether wirings are correct. (Whether polarities are correct.)
- Whether the number of connected instruments and connection distance are as specified.
- Whether communication conditions coincide between the master station (host computer) and slave stations (PXH).
  - Transmission speed : 9600bps, 19200bps, 38400bps
  - Data length : 8 bits
  - Stop bit : 1 bit
  - Parity :  odd
    - even
    - none
- Whether send/receive signal timing conforms to Section 5.4 in this manual.
- Whether the station No. designated as send destination by the master station coincides with the station No. of the connected PXH. (For PC loader communication, the station No. is fixed at "1".)
- Whether, at RS-485 communication, more than one instrument connected on the same transmission line does not share the same station No.
- Whether, at RS-485 communication, the station No. of instruments is not set at 0.  
If it is 0, the communication function does not work.
- Whether, at RS-485 communication, the 11th digit of type code of this controller is R.  
(PXH9□□□□ - □□R□□-□)
- Whether, at RS-485 communication, settings of communication conditions for RS-232C ↔ RS-485 converter are correct.

---

** Fuji Electric Co., Ltd.**

**International Sales Div  
Sales Group**

Gate City Ohsaki, East Tower, 11-2, Osaki 1-chome,  
Shinagawa-ku, Tokyo 141-0032, Japan  
<http://www.fujielectric.com>  
Phone: 81-3-5435-7280, 7281 Fax: 81-3-5435-7425  
<http://www.fujielectric.com/products/instruments/>

---