

Digital Controller

[Heating/cooling control type]

Type : PXH

User's Manual

BEFORE USE

Thank you very much for purchasing Fuji's digital controller (Heating/cooling control type).

- (1) Be sure to deliver this manual to the end user.
- (2) Be sure to read this manual and grasp the concept before operating the instrument.
- (3) The purpose of this manual is to provide detailed information on the function of the instrument. It does not guarantee that the instrument conforms to the specific purpose of the customer.
- (4) No part or the whole of this manual may be reproduced without Fuji Electric permission.
- (5) The contents of this manual may be changed without prior notice.

Note

Sufficient care has been taken to assure the accuracy of this manual. Please note that Fuji Electric is not responsible for any damage, including indirect damage, resulting from an error in writing, missing information, or the use of the information described in the manual.



©Fuji Electric Co., Ltd. 2006

Issued in January, 2006
Rev. 1st edition May, 2008
Rev. 2nd edition April, 2011
Rev. 3rd edition September, 2012

PLEASE READ FIRST

SAFETY WARNINGS

Please read the section “Safety Warnings” thoroughly before using. Please observe the warnings stated here as they contain important safety details. The safety warning items are divided into “WARNING” and “CAUTION” categories.

| | |
|--|--|
|  WARNING | Mishandling may lead to death or serious injury. |
|  CAUTION | Mishandling may cause injury to the user or property damage. |

⚠ WARNING

Limitations in use

This product was developed, designed and manufactured on the premise that it would be used for general machinery. In particular, if this product is to be used for applications that require the utmost safety as described below, please take into consideration the safety of the entire system and the machine by adopting such means as a fail-safe design, a redundancy design as well as the conducting of periodical inspections.

- Safety devices for the purpose of protecting the human body
- Direct control of transportation equipment
- Airplanes
- Space equipment
- Atomic equipment, etc,

Please do not use this product for applications which directly concern human lives.

Installation and wiring

- This equipment is intended to be used under the following conditions.

| | | |
|-----------------------|--|--------------|
| Ambient temperature | -10°C to 50°C | |
| Ambient humidity | 90% RH or below (with no condensation) | |
| Installation category | II | by IEC1010-1 |
| Pollution level | 2 | |

- Between the temperature sensor and the location where the voltage reaches the values described below, secure clearance space and creepage distance as shown in the table below. If such space cannot be secured, the EN61010 safety compliance may become invalid.

| Voltage used or generated by any assemblies | Clearance Space [mm] | Creepage Space [mm] |
|---|--------------------------------|---------------------|
| Up to 50 Vrms or Vdc | 0.2 | 1.2 |
| Up to 100 Vrms or Vdc | 0.2 | 1.4 |
| Up to 150 Vrms or Vdc | 0.5 | 1.6 |
| Up to 300 Vrms or Vdc | 1.5 | 3.0 |
| Above 300 Vrms or Vdc | Please consult our distributor | |

} hazardous voltage

- For the above, if voltage exceeds 50Vdc (called danger voltage), grounding and basic insulation for all terminals of the equipment and auxiliary insulation for warning outputs are required. Note that the insulation class for this equipment is as follows. Before installing, please confirm that the insulation class for equipment meets usage requirements.

| Power source | Internal Circuit |
|------------------------------------|--|
| Digital output (Do) 1, 2 | PC Loader Interface |
| | Measurement value input 1 (PV1) |
| | Measurement value input 2 (PV2) |
| Digital output (Do) 3 | Auxiliary analog Input 1 (Ai1) |
| Digital output (Do) 4 | Output 1 (Current / SSR driver) |
| Digital output (Do) 11 to 15 | Output 2 (Current / SSR driver) |
| | Digital input (DI) 1 to 4 |
| ————— Basic insulation (1500 V AC) | Digital input (DI) 11 to 15 |
| | ————— Functional insulation (500 V AC) |
| ----- No insulation | RS485 |

- In cases where damage or problems with this equipment may lead to serious accidents, install appropriate external protective circuits.
- As this equipment does not have a power switch or fuses, install them separately as necessary. (Main power switch: 2 point Breaker, fuse rating: 250 V 1A)
- For power supply wiring, use wire equal to 600 V vinyl insulation or above.
- To prevent damage and failure of the equipment, provide the rated power voltage.
- To prevent shock and equipment failure, do not turn the power ON until all wiring is complete.
- Before feeding power, confirm that clearance space has been secured to prevent shock and fire with the equipment.
- Do not touch the terminal while the machine is on. Doing so risks shock or equipment errors.
- Never disassemble, convert, modify or repair this equipment. Doing so carries the risk of abnormal operation, shock and fire.

Maintenance

- When installing and removing the equipment, turn the power OFF. Failing to do so may cause shock operational errors or failures.
- Periodic maintenance is recommended for continuous and safe use of this equipment. Some components used on this equipment have a limited life and/or may deteriorate over time.
- The warranty period for this unit (including accessories) is one year, if the product is used properly.

Caution

Cautions when installing

Please avoid installing in the following locations.

- Locations in which the ambient temperature falls outside the range of -10°C to 50°C when equipment is in use. (If the power supply is 200 V AC, the recommended maximum ambient temperature is 45°C .)
- Locations in which the ambient humidity falls outside the range of 0 to 90% RH when equipment is in use
- Locations with rapid temperature changes, leading to dew condensation
- Locations with corrosive gases (especially sulfide gas, ammonia, etc.) or flammable gases
- Locations in contact with water, oil, chemicals, steam or hot water (If the equipment gets wet, there is a risk of electric shock or fire, so have it inspected by the distributor.)
- Locations with high concentrations of atmospheric dust, salt or iron particles
- Locations with large inductive interference, resulting in static electricity, magnetic fields or noise
- Locations in direct sunlight.
- Locations that build up heat from radiant heat sources, etc.

Cautions when attaching the panels

- Please attach the PXH with the included Fixtures (2 pieces) to the top and bottom, and tighten with a screwdriver.

The clamp torque is approximately $0.15\text{ N}\cdot\text{m}$ ($1.5\text{ kg}\cdot\text{cm}$)

It is designed such that overtightening will cause left/right cracking to the central area of the Fixtures and hence reduce the torque.

Cracking to the central area will not cause any problems in terms of usability of the equipment as is.

(However, do exercise caution in not applying too much torque because the casing is made of plastic.)

Cautions for wire connections

- For thermocouple input, use the designated compensation lead; for resistance temperature sensors, use wires with small lead wire resistance and without any resistance difference among the three wires.
- To avoid noise conductor effects, do not use input signal wires in close proximity with electric power lines or load lines.
- Use input signal lines and output signal lines that are separated from each other and are shielded.
- If there is a lot of noise from the power source, adding an insulation transducer and using a noise filter is recommended.

(Example: TDK ZMB22R5-11 noise filter)

Always attach a noise filter to a panel that is grounded securely, and keep the wiring between the noise filter output side and the measuring equipment power terminal wiring to a minimum length. Please do not attach fuses and switches, etc. to the noise filter output wiring since doing so will decrease the filter's effectiveness.

- Twisting the measuring instrument wiring is effective when connecting the wires.
(The shorter the pitch of the twist, the more effective the connection is against noise.)
- Operation preparation time is required for the contact output when power is turned on. If using it as a signal to an external interlock circuit, please couple it with a delayed relay.
- Concerning the output relay, connecting the maximum rated load will shorten the product's life; so please attach an auxiliary relay. If the output operation frequency is high, selecting a SSR/SSC drive output type is recommended.

[Proportionate cycles] Relay output: 30 seconds or more,
SSR/SSC drive output: 1 second or more

- When inductive loads such as magnetic opening/closing equipment, etc. as relay output equipment are connected, use of "Zetrap," manufactured by Fuji Device Technology Co. Ltd., is recommended in order to protect the connection points against opening/closing surges and to ensure long-term use.

Model names : ENC241D-05A (For 100 V power voltage)
ENC471D-05A (For 200 V power voltage)

Others

- Please do not wipe the equipment with organic solvents such as alcohol or benzene, etc. If wiping is necessary, do so with a neutral cleaning agent.
- Do not use mobile phones near the instrument (within 50 cm). Otherwise malfunction may occur.

CONTENTS

| | |
|---|-----------|
| BEFORE USE | 1 |
| PLEASE READ FIRST | 2 |
| CONTENTS | 6 |
| 1 OUTLINE | 9 |
| 1-1 Code symbols | 9 |
| 1-2 Checking the delivered items | 10 |
| 1-3 Operating parts and their functions | 11 |
| 1-4 Digital characters | 12 |
| 2 INSTALLATION AND WIRING | 13 |
| 2-1 Installation site | 13 |
| 2-2 External and panel cut dimensions | 14 |
| 2-3 Mounting the PXH to the panel | 15 |
| 2-4 Before wiring | 16 |
| 2-5 Wiring | 17 |
| 3 BASIC USAGE | 19 |
| 3-1 Setting control template | 21 |
| 3-2 Setting input | 27 |
| 3-3 Setting output type | 36 |
| 3-4 Reset command | 38 |
| 3-5 Outline of function of heating/cooling control type | 40 |
| 3-6 Setting the set value (SV) | 53 |
| 3-7 AT (Auto tuning) | 55 |
| 3-8 Alarm function | 58 |
| 3-9 Re-transmission output | 66 |
| 3-10 Setting communications | 73 |
| 4 OPERATION | 77 |
| 4-1 Auto operation | 80 |
| 4-2 Manual operation | 82 |
| 4-3 Remote operation (SV=Auxiliary input Ai1) | 84 |
| 4-4 SV selection function (Remote operation) | 86 |
| 4-5 Standby function | 87 |
| 4-6 How to use monitoring function | 89 |
| 5 ADVANCED USAGE | 90 |
| 5-1 Setting inputs | 90 |
| 5-2 Setting output | 92 |
| 5-3 Setting PID | 93 |
| 5-4 Setting hysteresis | 95 |
| 5-5 Setting bAL, Arh, and ArL | 96 |
| 5-6 Palette function | 97 |
| 5-7 Key lock | 98 |
| 5-8 Setting output direction at the input error burnout | 99 |
| 5-9 User adjustment | 100 |
| 5-10 Digital input (Di) function | 101 |
| 5-11 Digital output (Do) function | 105 |
| 5-12 Setting LED allocation | 107 |
| 5-13 Function key | 109 |
| 5-14 Math function | 114 |
| 5-15 Remote operation prohibition | 117 |
| 5-16 Remote acknowledge (R-ACK) function | 118 |
| 5-17 Manual operation prohibition | 119 |

| | |
|---|------------|
| 5-18 Operation mode at the time of power ON | 120 |
| 5-19 SV tracking function | 121 |
| 5-20 Password | 122 |
| 5-21 Parameter mask | 123 |
| 5-22 EX-MV function | 124 |
| 5-23 Setting 2 degrees of freedom PID | 125 |
| 5-24 Screen display selection function | 126 |
| 5-25 Totalizer function | 127 |
| 5-26 Recipe function | 138 |
| 5-27 Linearize function | 141 |
| 5-28 Data change through communications | 143 |
| 5-29 Ramp/Soak | 145 |
| 6 TROUBLESHOOTING | 153 |
| 7 FREQUENTLY ASKED QUESTIONS | 156 |
| 8 SPECIFICATIONS | 157 |
| Appendix 1 Terminal connection diagram | 159 |
| Appendix 2 Parameter list | 160 |
| 9 INDEX | 179 |

CONTENTS

1 OUTLINE

Thank you very much for purchasing Fuji's digital controller (Heating/cooling control type). This manual describes the installation, operation, maintenance, etc. of this instrument. Read it carefully before operating the controller.

1-1 Code symbols

Before using the controller, check that the controller is of the type you ordered.

| Digit | Description | Notes | 1 | 2 | 3 | 4 | 5 | 6 | 7 | 8 | 9 | 10 | 11 | 12 | 13 |
|-------|--|-------|---|---|---|---|---|---|---|---|---|----|----|----|----|
| | | | P | X | H | 9 | F | 1 | | | V | | | | 0 |
| 4 | <Dimension of front face H x W> 96 x 96 mm | | | | | | 9 | | | | | | | | |
| 5 | <Number of control loops/Function> Heating/cooling controller | | | | | | | F | | | | | | | |
| 6 | <Measurement value input> Universal input: 1 point Universal input: 2 points | *1 | | | | | | | 1 | 2 | | | | | |
| 7 | <Auxiliary input> Not fitted DC voltage: 1 point | | | | | | | | 0 | 1 | | | | | |
| 8 | <Version No.> | | | | | | | | | 1 | | | | | |
| 9 | <Output> OUT1 OUT2 | *3 | | | | | | | | | | 1 | 2 | 3 | 5 |
| | Current Not fitted | | | | | | | | | | | | | | |
| | Current Current | | | | | | | | | | | | | | |
| | Current SSR/SSC drive | | | | | | | | | | | | | | |
| | Current Transmitter supply | | | | | | | | | | | | | | |
| | SSR/SSC driver Not fitted | | | | | | | | | | | | | | |
| | SSR/SSC driver Current | | | | | | | | | | | | | | |
| | SSR/SSC driver SSR/SSC drive | | | | | | | | | | | | | | |
| | | | | | | | | | | | | | | | |
| 10 | <Power supply> 100 to 240 V AC | | | | | | | | | | | | V | | |
| 11 | <Communication interface> Not fitted RS-485 | | | | | | | | | | | | | 0 | R |
| 12 | <Digital input/output> Digital input Digital output (Including relay control output) | *2 | | | | | | | | | | | | | |
| | 4 points (Di1 to Di4) 2 points (Do3, Do4) | | | | | | | | | | | | | | |
| | 4 points (Di1 to Di4) 4 points (Do1 to Do4) | | | | | | | | | | | | | | |
| | 9 points (Di1 to Di4, Di11 to Di15) 9 points (Do1 to Do4, Do11 to Do15) | *1 | | | | | | | | | | | | | |
| 13 | <Additional specifications> Not fitted. | | | | | | | | | | | | | | 0 |

*1: "2" for the 6th digit and "B" for the 12th digit cannot be specified at the same time.
 *2: One digital output (Do4) or 2 points (Do3 and 4) is occupied when relay is allocated as control output.
 *3: Explanation of the 9th digit of type code and output terminal function is below.

| Code | 9th digit | Terminal | Do3 | Do4 | OUT1 | | OUT2 | | Transmitter power supply |
|------|-----------|-------------|----------------------------------|----------------------------------|--|----------------|--|----------------|--------------------------|
| | | Output Kind | Relay | Relay | Current (4 to 20 mA) | SSR/SSC driver | Current (4 to 20 mA) | SSR/SSC driver | |
| | | Function * | Control output or Digital output | Control output or Digital output | Control output or Re-transmission output | Control output | Control output or Re-transmission output | Control output | |
| | 1 | ○ | ○ | ○ | — | — | — | — | |
| | 2 | ○ | ○ | ○ | — | ○ | — | — | |
| | 3 | ○ | ○ | ○ | — | — | ○ | — | |
| | 5 | ○ | ○ | ○ | — | — | — | ○ | |
| | A | ○ | ○ | — | ○ | — | — | — | |
| | B | ○ | ○ | — | ○ | ○ | — | — | |
| | C | ○ | ○ | — | ○ | — | ○ | — | |

*The selection of "Function" is specified according to the parameter.

1. OUTLINE

1-2 Checking the delivered items

Confirm that all of the following accessories are included.

- Digital Controller..... 1 unit
- Instruction Manual..... 1 copy
- CD-ROM 1 pc.
 - (Contents)
 - Instruction Manual
 - User's Manual
 - Communication Functions Instruction Manual (Modbus)
 - Communication Sample Program
 - Parameter Loader Instruction Manual
 - Parameter loader software
- Mounting fixture..... 2 pcs.
- Waterproof packing 1 pc.
- Unit nameplate..... 1 pc.
- Terminating resistance *1 1 pc.
 - *1) Supplied only when the communications function (RS485) is selected with this model.

Option

| Name | Order No. |
|-------------------------------|-----------------|
| PC loader communication cable | ZZPPXH*TK4H4563 |
| Terminal covers *2 | ZZPPXR1-B230 |

*2) Two pieces are required per unit.

1-3 Operating parts and their functions

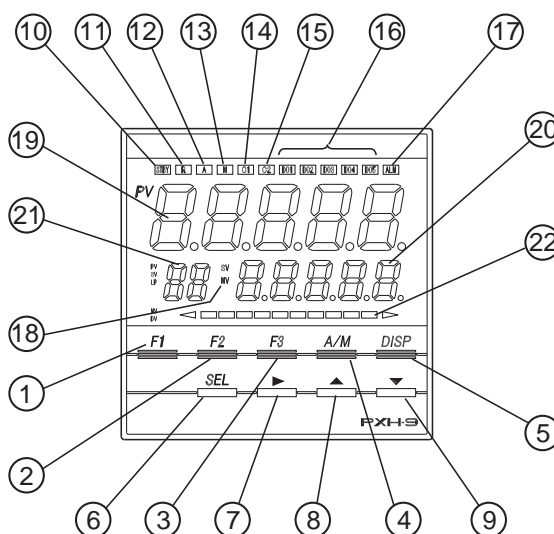

Operation Part

| Name | Function |
|--|---|
| ① F1 key | Assignable by the user. |
| ② F2 key | Assignable by the user. |
| ③ F3 key | Assignable by the user. |
| ④ A/M key (AUTO/MANUAL switch key) | Switches between AUTO mode and MANUAL mode. |
| ⑤ DISP key (switch display key) | Switches display between the set value (SV) / control output (MV). Press the key to return from the setting mode to the operation mode (operation screen). |
| ⑥ SEL key (Select key) | For parameter block selection, parameter selection, and parameter setting change. |
| ⑦ ► key (Digit selection key) | Select a digit of data value for a desired setting change. |
| ⑧ ▲ key (Up key) | Increases the data value of a desired setting change. Changes the value of a set value (SV) when in operation. Used to select channels and parameters and change parameter settings in the setting mode. |
| ⑨ ▼ key (DOWN key) | Decreases the data value of a desired setting change. Changes the value of a set value (SV) when in operation. Used to select channels and parameters and change the parameter setting in the setting mode. |

Note) For the current output, the lamp will not light.

Display

| Name | Function |
|--|---|
| ⑩ STBY Lamp | Stays on in standby mode. |
| ⑪ R Lamp | Stays on in REMOTE mode. |
| ⑫ A Lamp | Stays on in AUTO mode. |
| ⑬ M Lamp | Stays on in MANUAL mode. |
| ⑭ C1 Lamp | Stays on while heating output is ON. ^{Note} |
| ⑮ C2 Lamp | Stays on while cooling output is ON. ^{Note} |
| ⑯ DO1 Lamp DO2 Lamp DO3 Lamp DO4 Lamp DO5 Lamp | Stays on while digital output 1 to 4 (DO1 to DO4) is on. The lamp functions are assignable by the user. |
| ⑰ ALM Lamp | Stays on while alarm is activated. |
| ⑱ SV/MV Lamp | Indicates the status shown in the sub-segment display. SV: Set value MV: Control output value |
| ⑲ Measurement value (PV) display | Displays the measurement value (PV) during operation. Also displays the parameter name when setting parameters. |
| ⑳ Set value (SV) display (orange) or control output value (MV) display | Displays the set values (SV) or control output value (MV) during operation. Displays lower 5 digits of the integrated value in integrated value display. |
| ㉑ Sub-segment display | During operation: When TPLT (ch8-92) is set at 50 or 53 the loop number is displayed. When TPLT (ch8-92) is set at 51 or 54, the SV number is displayed. Displays higher 2 digits of the integrated value in integrated value display. Setting parameters: Parameter number is displayed. |
| ㉒ Bar graph display | Displays a bar graph of control output (MV) during operation. |

1. OUTLINE

1-4 Digital characters

The following tables provide correspondence between digital characters used for the display of the controller and alphanumerical characters.

| Alphabet | Digital character | Alphabet | Digital character | Alphabet | Digital character |
|----------|-------------------|----------|-------------------|----------|-------------------|
| A | <i>A</i> | K | <i>k</i> | U | <i>U</i> |
| B | <i>b</i> | L | <i>L</i> | V | <i>v</i> |
| C | <i>C</i> | M | <i>M</i> | W | <i>W</i> |
| D | <i>d</i> | N | <i>n</i> | X | <i>X</i> |
| E | <i>E</i> | O | <i>o</i> | Y | <i>Y</i> |
| F | <i>F</i> | P | <i>P</i> | Z | <i>Z</i> |
| G | <i>G</i> | Q | * | | |
| H | <i>h</i> | R | <i>r</i> | | |
| I | <i>i</i> | S | <i>S</i> | | |
| J | <i>J</i> | T | <i>T</i> | | |

| Numeric character | Digital character | Numeric character | Digital character |
|-------------------|-------------------|-------------------|-------------------|
| 1 | <i>1</i> | 6 | <i>6</i> |
| 2 | <i>2</i> | 7 | <i>7</i> |
| 3 | <i>3</i> | 8 | <i>8</i> |
| 4 | <i>4</i> | 9 | <i>9</i> |
| 5 | <i>5</i> | 0 | <i>0</i> |

* Not used by PXH.

2 INSTALLATION AND WIRING

2-1 Installation site

Install the controller in the following places.

- A place where ambient temperature falls within the range from -10°C to 50°C , and temperature change is minimal (We recommend you to use the controller at the ambient temperature of 45°C at the maximum if the power supply is 200 V AC.).
- A place where ambient humidity falls within the range from 0 to 90%RH, and where condensation does not occur.
- A place where corrosive gases (such as sulfuric gas or ammonia) or inflammable gases are not generated.
- A place where vibration or impact is not directly transferred to the main unit (The output relay may malfunction because of vibration or impact.).
- A place not subjected to exposure to water, oil, chemicals, vapor, and steam (If water is splashed onto the controller, electrical leak or fire may occur. Ask your distributor for maintenance in such cases.).
- A place where accumulation of heat due to radiant heat does not occur.
- A place where electromagnetic interference by radios or mobile phones does not occur.
- A place where dust, salt, or iron content is minimal.
- A place not subjected to direct sunlight.
- A place where inductive interference is large and therefore not prone to generation of static electricity, magnetism, and noise.

2-2 External and panel cut dimensions

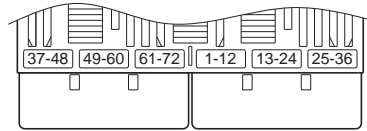
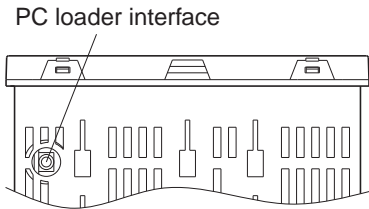
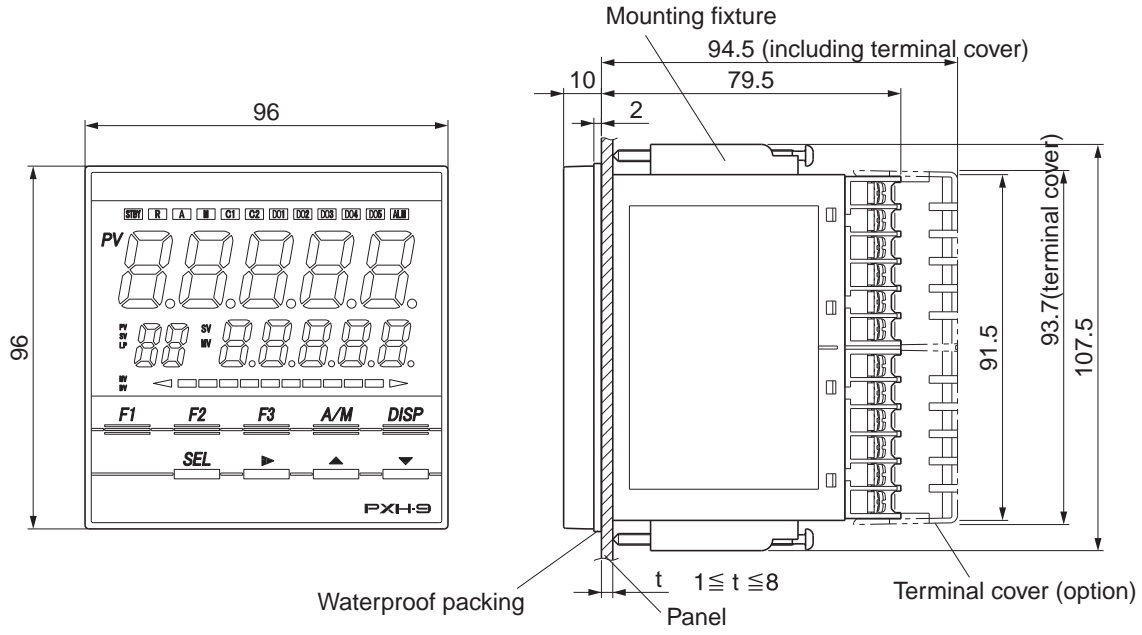

Panel Cutout Dimensions

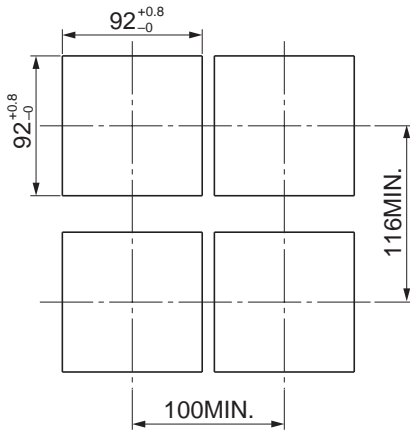

Note: In the case where a paint finish will be applied after panel hole-punching, take care of the finished dimensions.

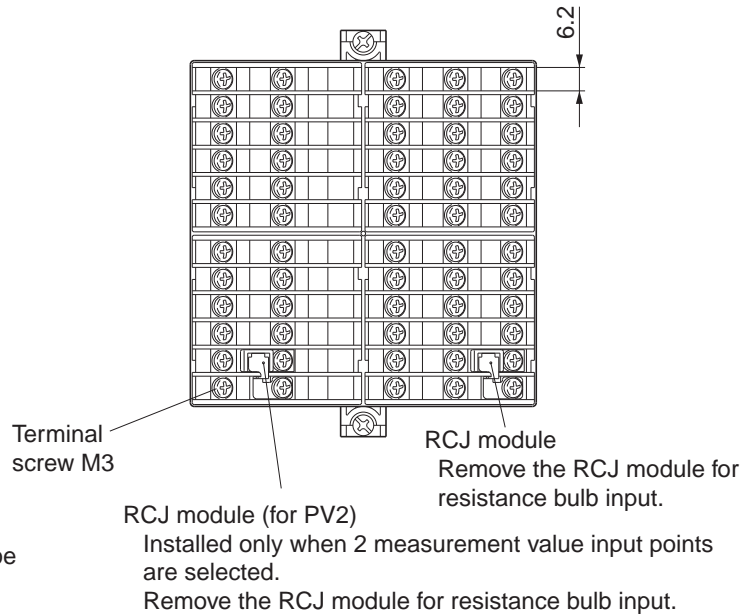

2-3 Mounting the PXH to the panel

- Please attach the PXH with the included Fixtures (2 pieces) to the top and bottom, and tighten with a screwdriver.
The clamp torque is approximately 0.15 N·m (1.5 kg·cm)
(However, do exercise caution in not applying too much torque because the casing is made of plastic.)
- The front of this equipment is waterproof in compliance with NEMA-4X standards (IP66-equivalent). However, regarding waterproofing between the equipment and the panel, use the included packing to ensure waterproofing and attach it according to the guidelines below. (Incorrect attachment may cause the equipment to lose its waterproof capabilities.)
(1) As shown in Fig. 1, insert the panel after attaching the packing to the equipment case.
(2) As shown in Fig. 2, tighten the fixture screws so that no gaps can remain between the equipment face, the packing and the panels. Once finished, confirm that there are no changes in shape such as displaced or improperly-fitted packing, etc. as shown in Fig. 3.
- Please exercise caution if the panel strength is weak and gaps develop between the packing and the panel, as this will result in the loss of its waterproofing capabilities.

Mounting Method

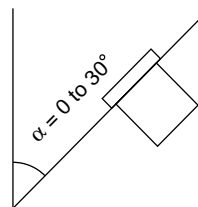
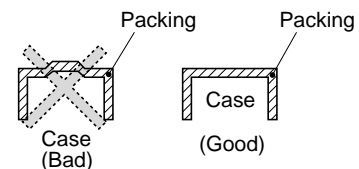
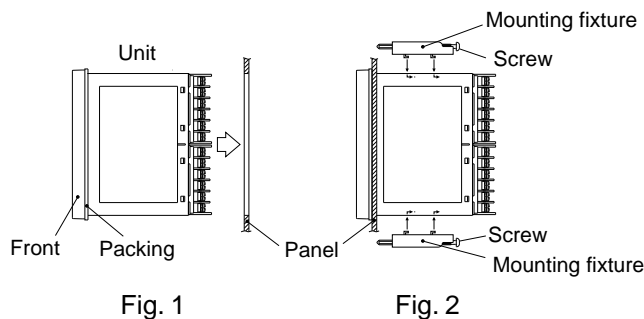

Standard: vertical panel attachment (horizontal position installing)
If attached at an angle, the maximum gradient is a 30° downslope.

(Caution)

- In order not to hamper heat radiation, do not block the sides of the equipment.
- Do not block the air vents on the upper part of the terminal.
- For the PXH9, please attach the Fixtures to the attachment holes in the center of the main unit.

2-4 Before wiring

- Use wires and crimp-style terminals of the size shown below for connection.

Wire size

| Parts | Size |
|-------------------------------------|---------------------------------|
| Thermocouple (Compensation wire) | 1.25 mm ² or smaller |
| Wire | 1.25 mm ² or smaller |

Crimp-style terminal

| Applicable wire size | Fastening torque |
|------------------------------|------------------|
| 0.25 to 1.25 mm ² | 0.8 N·m |

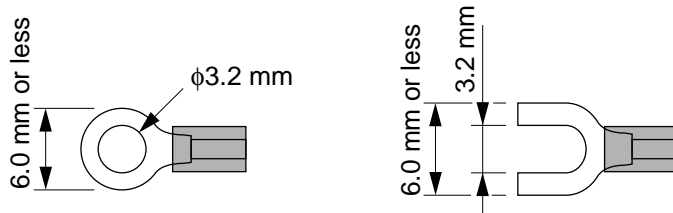

2-5 Wiring

- For thermocouple input use the appropriate compensating cable, for resistance bulb sensors, use wires with small resistance and without any resistance difference among the three wires.
- To avoid noise conductor effects, do not use input signal wires in close proximity with electric power lines or load lines.
- Use input signal lines and output signal lines that are separated from each other and are shielded.
- If there is a lot of noise from the power source, adding an insulation transducer and using a noise filter is recommended.

(Example: TDK ZMB22R5-11 noise filter)

Always attach a noise filter to a panel that is grounded securely, and keep the wiring between the noise filter output side and the measuring equipment power terminal wiring to a minimum length. Please do not attach fuses and switches, etc. to the noise filter output wiring since doing so will decrease the filter's effectiveness.

- Twisting the measuring instrument wiring is effective when connecting the wires.
(The shorter the pitch of the twist, the more effective the connection is against noise.)
- It takes preparation time before operation starts for the contact output when power is turned on. If using it as a signal to an external interlock circuit, please couple it with a delayed relay.
- Concerning the output relay, connecting the maximum rated load will shorten the relay's life; so please attach an auxiliary relay. If the output operation frequency is high, selecting a SSR/SSC drive output type is recommended.

[Proportional cycles] Relay output: 30 seconds or more,
SSR/SSC drive output: 1 second or more

- When inductive loads such as magnetic opening/closing equipment, etc. as relay output equipment are connected, use of "Zetrap," manufactured by Fuji Device Technology, Co. Ltd., is recommended in order to protect the connection points against opening/closing surges and to ensure long-term use.

Model names : ENC241D-05A (For 100V power voltage)
ENC471D-05A (For 200V power voltage)

Attachment position : Please connect between the relay control output connection points. (Refer to Fig. 5.)

- If using a thermocouple input, make sure that an RCJ module is connected as shown in Fig. 5.
(If an RCJ module is not connected, the temperature measurement cannot function.)
To use resistance bulb input instead of thermocouple input, remove RCJ module.
Keep the removed RCJ module, and do not forget to mount it back again when input is changed.
- Take wiring resistance into consideration when using a Zener barrier.
- In applying mV voltage, do not remove the RCJ module.
- It is dangerous to make an SSR connection when the output is set at 4-20mA, because the output will be kept "ON" even when the MV display shows -5%. Make sure to confirm the setting and the wiring before making the SSR connection.
- When the transmitter power supply model is selected, the external wiring will be connected as Fig. 6.

2 INSTALLATION AND WIRING

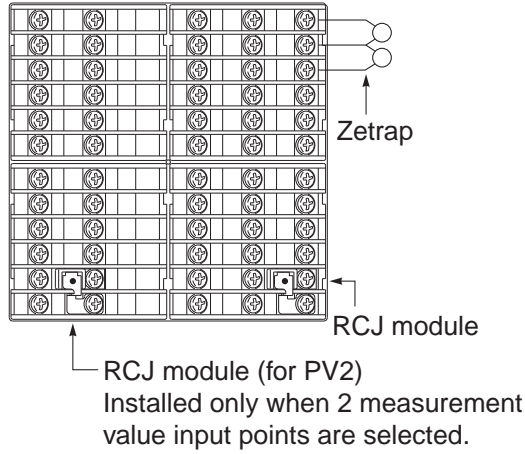
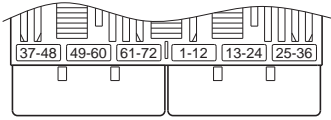

Fig. 5 Attachment position of Zetrap and RCJ module

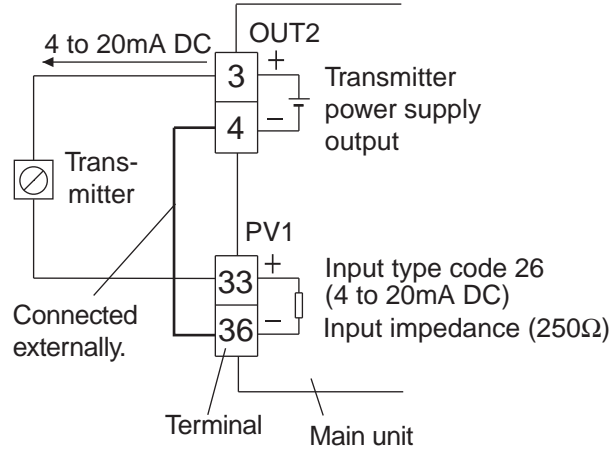
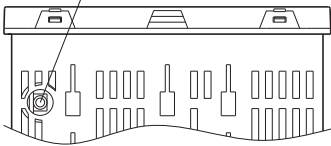

Fig. 6 External wiring for the model with the transmitter power supply

PC loader interface



- To connect the main unit to a PC, connect the optional PC loader communication cable to the PC loader interface and the serial port (RS232C) of the PC.

- Connection when terminal cover is used
To connect 2 cables to one terminal, use cables of 1.25 mm² or smaller in diameter, and make connections as shown by the figure at right.

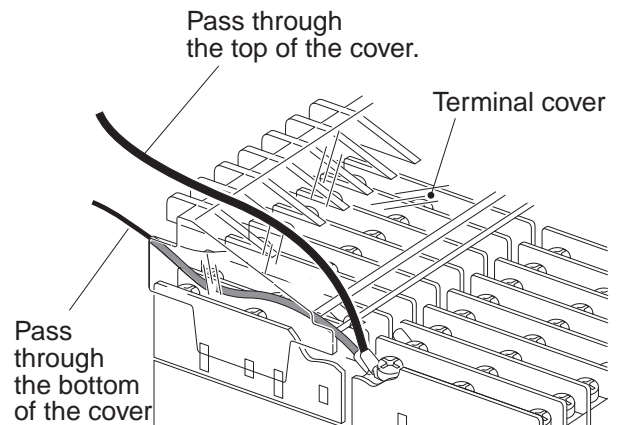

3 BASIC USAGE

Basic settings required in the flow from power ON to the start of operation are shown below. See the next page for basic key operations.

Setting procedure

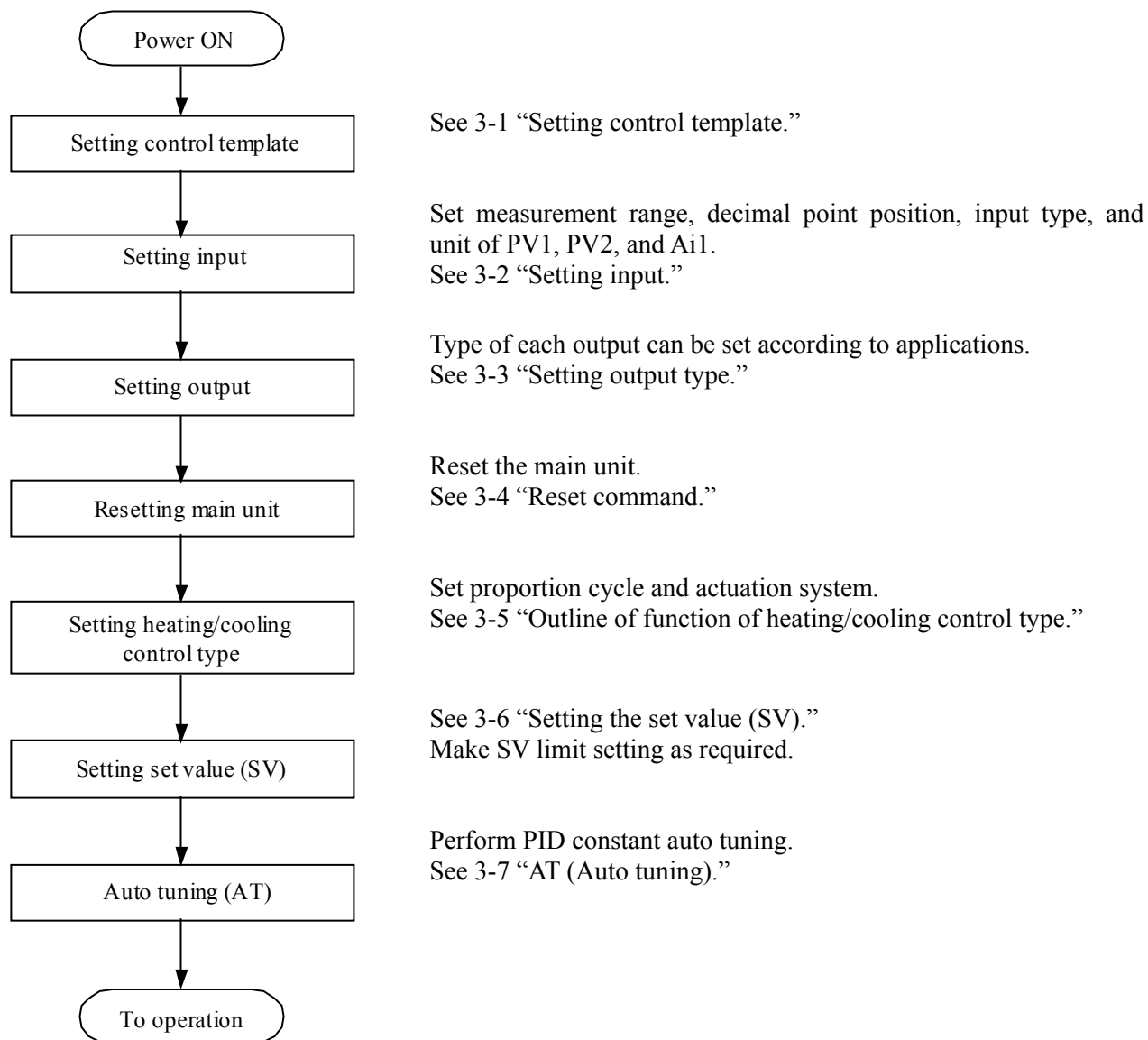

[Note]

- * To enable the setting of [rEv1] of Ch2, Ch9, ChB, and Ch8 that has been registered, reset the controller or turn on the power again.
- * If key operation is not performed for 10 seconds under the condition where the setting is flickering in setting change mode, the value being changed is canceled.
- * This instrument is not provided with the function of automatically returning to the operation screen when no operation status is continued. Return to the operation screen manually.
- * Parameters in the text are expressed as shown below.

Example: STbo (Ch1 - 5)



Switching parameters

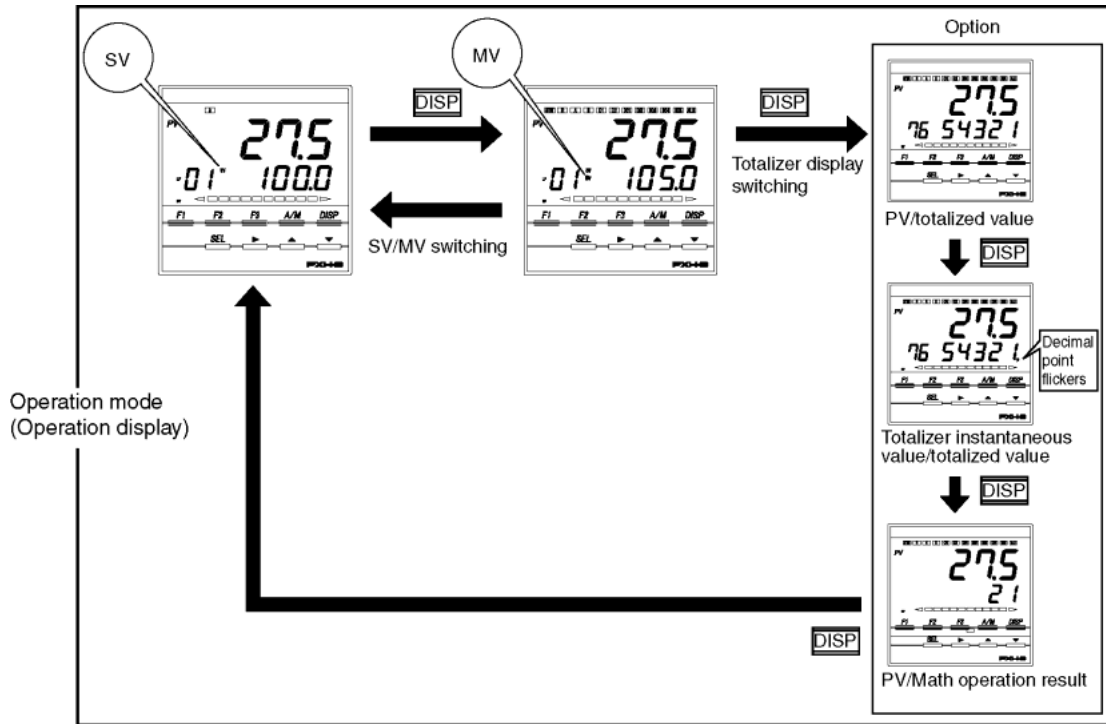

SEL ↓ ↑ DISP

| | | | | | | | | |
|-------------------|------------|-----|------------|-----|-----|-----|-----|-----|
| Channel selection | Password 1 | Ch1 | Password 2 | Ch2 | Ch3 | Ch7 | Ch8 | Ch9 |
| | PS1 | oPE | PS2 | Pcd | PLr | Non | SEr | SYS |
| | ChA | ChB | ChC | ChD | ChE | ChG | ChH | ChX |
| | RLn | CoN | Lnr | CLC | AR | roF | rS | rCP |

Press **SEL** or in PS1 or PS2 Press **SEL** to confirm
 Press **DISP** to confirm

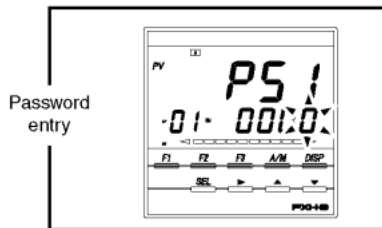

After selecting a desired channel, press **SEL** or .

If the value entered does not allow PS1=PAS1 (Ch9-1) or PS2=PAS2 (Ch9-2) to hold, the later channels cannot be selected.

Parameter selection

| | |
|---------------|----------------|
| Parameter No. | Parameter name |
| 01 | LrEN1 |
| ... | ... |
| 37 | L JP3 |

.....

| | |
|---------------|----------------|
| Parameter No. | Parameter name |
| 01 | HrCP0 |
| ... | ... |
| 90 | H d79 |

* See appended parameter list.

3-1 Setting control template

TPLT Specifying control template (Setting range: 50, 51, 53, 54)

[Description]





- Specify control templates.

| TPLT | Control template | SV selection | Math function |
|------|--|--------------|---------------|
| 50 | Single-loop heating/cooling control (with math function) | — | ○ |
| 51 | Single-loop SV selectable heating/cooling control (with math function) | ○ | ○ |
| 53 | Single-loop heating/cooling control | — | — |
| 54 | Single-loop SV selectable heating/cooling control | ○ | — |

<Factory set>

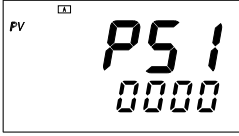
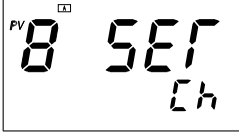
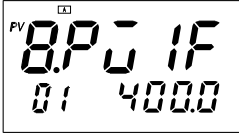
- Each template is provided with an input conditioner function.
Input conditioner function allows the following four operations.
 - (1) User adjustment
 - (2) Square root extraction
 - (3) Input filter
 - (4) Linearize
- Math function can be selected for templates No. 50 and No. 51, and SV selection can be selected for templates No. 51 and No. 54. See the template chart on the next page for details.
- * See 5-14 “Math function.” for Math function.
See 4-4 “SV selection function (Remote operation)” for SV selection function.

[Setting example] Setting the template to be used to 51.

| Display | Operation procedure |
|--|---|
|  <p>Operation display</p> | <p>1. Check that the operation display is shown.</p> |
|  <p>Channel selection display</p> | <p>2. Press the [SEL] key, and the channel selection display appears, displaying <i>P51</i>.</p> |
|  <p>Channel selection display</p> | <p>3. Press the [▽] key to display <i>8 SER</i>.</p> |
|  <p>Parameter selection display</p> | <p>4. Press the [SEL] or the [▶] key, and <i>8P51F</i> appears and the parameter selection display is shown</p> |
|  <p>Parameter selection display</p> | <p>5. Press the [▽] key to display <i>8PPLF</i>.</p> |
|  <p>Setting change mode</p> | <p>6. Press the [SEL] or the [▽] key to make the setting flicker, and set the value to <i>00051</i> using the [▶], [▲] or the [▽] key.</p> |
|  <p>Parameter selection display</p> | <p>7. Press the [SEL] key to register the setting.</p> |
|  <p>Operation display</p> | <p>8. Press the [DISP] key once to return to the parameter selection display. Press it again to return to the operation display.</p> |

Template No. 50 **Single-loop heating/cooling control type (with math function)**

Contents of input conditioner

- User adjustment
- Square root extraction
- Input filter
- Linearize

1 The value obtained by calculating the input values PV1, PV2, and Ai1 can be controlled as PV.

< Practical operations >

- Flow rate/compensation with temperature and Pressure
- Averaging (Weighting allowed)
- Maximum/minimum selector
- Input signal switching
- Calorie calculation

(See section 5-14 for details of arithmetic expressions.)

- Others

2 See template No. 53 for the functions other than math function.

Note 1) Scale setting [UCF1, UCB1, and UCD1 (Ch8-89 to 91)] should be made according to the range of operation result.

Note 2) In manual operation, the setting of EX-MV (Ch2-97 EXM1) and the setting at occurrence of an input error (Ch9-35 brd1) are for the MV value before it is allocated to heating/cooling output. If setting is made so that MV=50% holds, the output both on heating and cooling sides is set to OFF (when heating output rEV1 is set to REV, and cooling output rVc1 to NRML only).

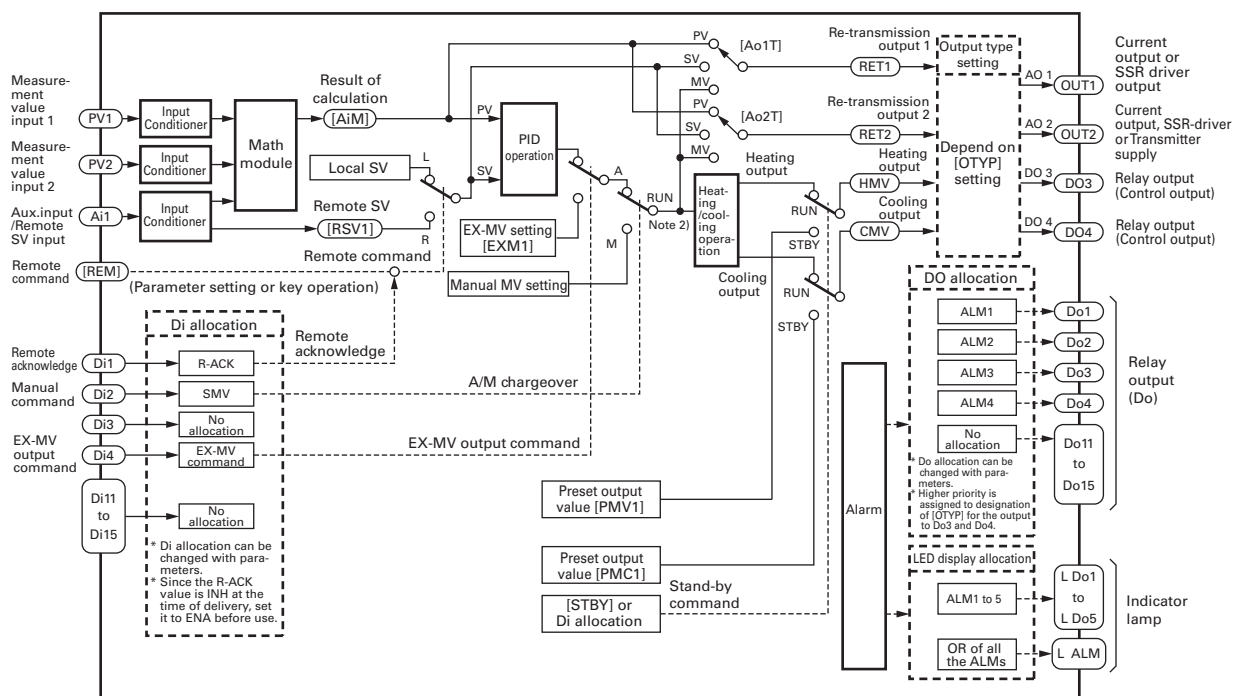

Template No. 51 Single-loop SV selection heating/cooling control type (with math function)

- 1** Use the template to perform math operation with PV1, PV2, and Ai1 in SV selection control.
- 2** See template No. 54 for the functions other than math function.

Note 1) Scale setting [UCF1, UCB1, and UCD1 (Ch8-89 to 91)] should be made according to the range of operation result.

Note 2) In manual operation, the setting of EX-MV (Ch2-97 EXM1) and the setting at occurrence of an input error (Ch9-35 brd1) are for the MV value before it is allocated to heating/cooling output. If setting is made so that MV=50% holds, the output both on heating and cooling sides is set to OFF (when heating output rEV1 is set to REV, and cooling output rVc1 to NRML only).

SV selection signal and SV No. selected

| Selection SV No. | SV selection Signal 1 | SV selection Signal 2 | SV selection Signal 3 |
|------------------|-----------------------|-----------------------|-----------------------|
| Local SV | OFF | OFF | OFF |
| SV1 | ON | OFF | OFF |
| SV2 | OFF | ON | OFF |
| SV3 | ON | ON | OFF |
| SV4 | OFF | OFF | ON |
| SV5 | ON | OFF | ON |
| SV6 | OFF | ON | ON |
| SV7 | ON | ON | ON |

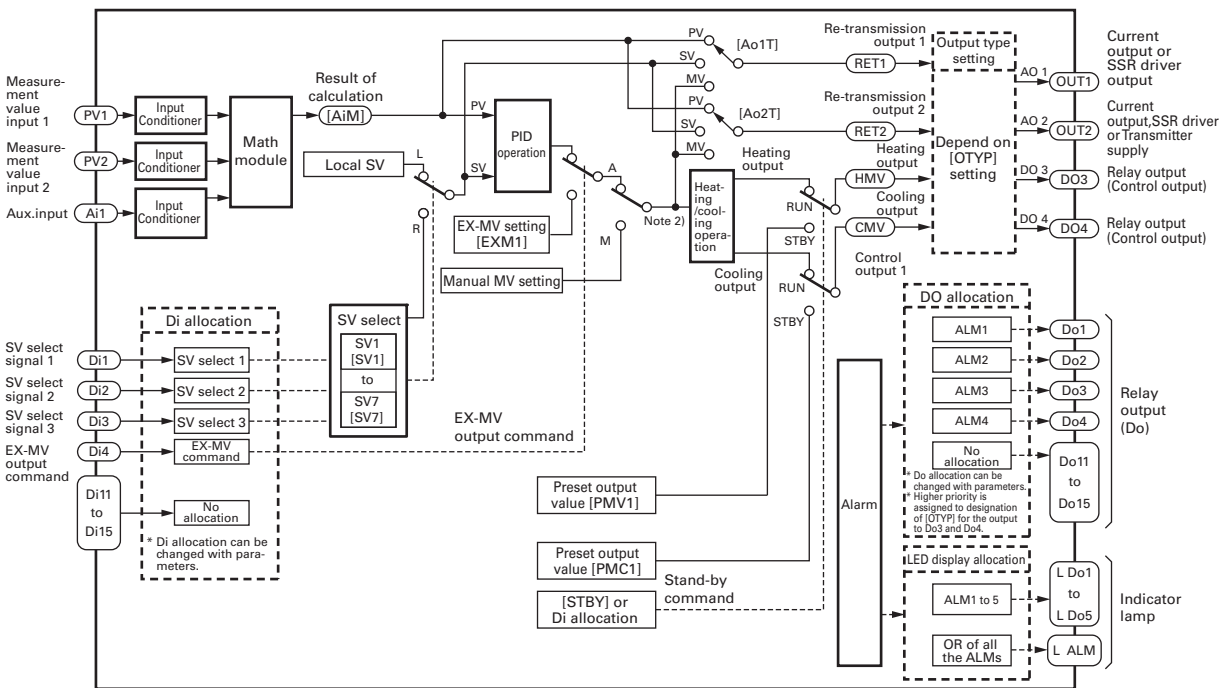

Template No. 53 Single-loop heating/cooling control type

- 1 Template No. 53 is the most basic control template.
- 2 Control is made by digital input in Auto/Manual/Remote operation mode.
- 3 Re-transmission output is set with parameters [Ao1T, Ao2T].
- 4 By changing digital input (Di) allocations, standby operation, etc. are allowed.
- 5 Digital output (Do) and LED lamp allocation can be changed.

Note 1) In manual operation, the setting of EX-MV (Ch2-97 EXM1) and the setting at occurrence of an input error (Ch9-35 brd1) are for the MV value before it is allocated to heating/cooling output. If setting is made so that MV=50% holds, the output both on heating and cooling sides is set to OFF (when heating output rEV1 is set to REV, and cooling output rVc1 to NRML only)

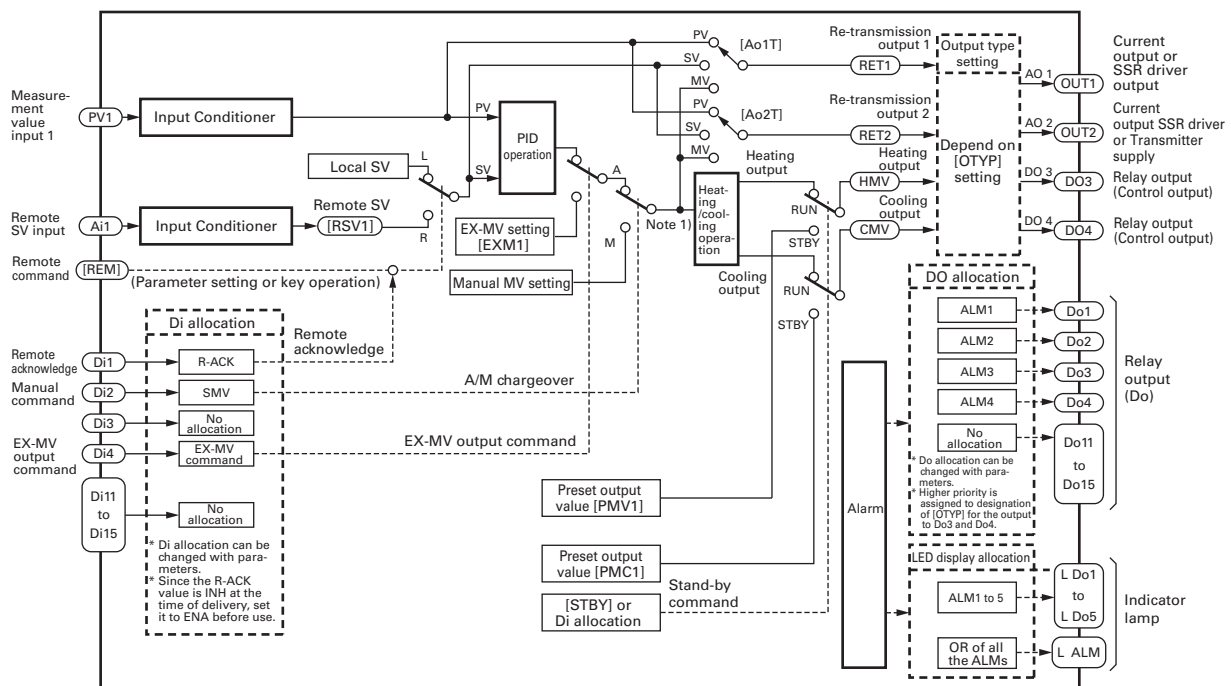

Template No. 54 Single-loop SV selection heating/cooling type control

- 1** The set value (SV) can be selected by digital input. The SV can be selected from local (front face) setting and 7 pairs of palette setting (SV of Ch4), 8 points in total.
- 2** The PID parameter can also be switched according the SV. (Set PLTS [ch9-31] to SV.)
- 3** Set the control output and transfer output with parameter [OTPY].
- 4** By changing the allocation of digital input (Di), standby operation, etc. can be made.
- 5** The allocation of digital output (Do) and LED lamp can be changed.
See the description of template No. 51 for the SV selection signal and SV No. selected.

Note 1) In manual operation, the setting of EX-MV (Ch2-97 EXM1) and the setting at occurrence of an input error (Ch9-35 brd1) are for the MV value before it is allocated to heating/cooling output. If setting is made so that MV=50% holds, the output both on heating and cooling sides is set to OFF (when heating output rEV1 is set to REV, and cooling output rVc1 to NRML only).

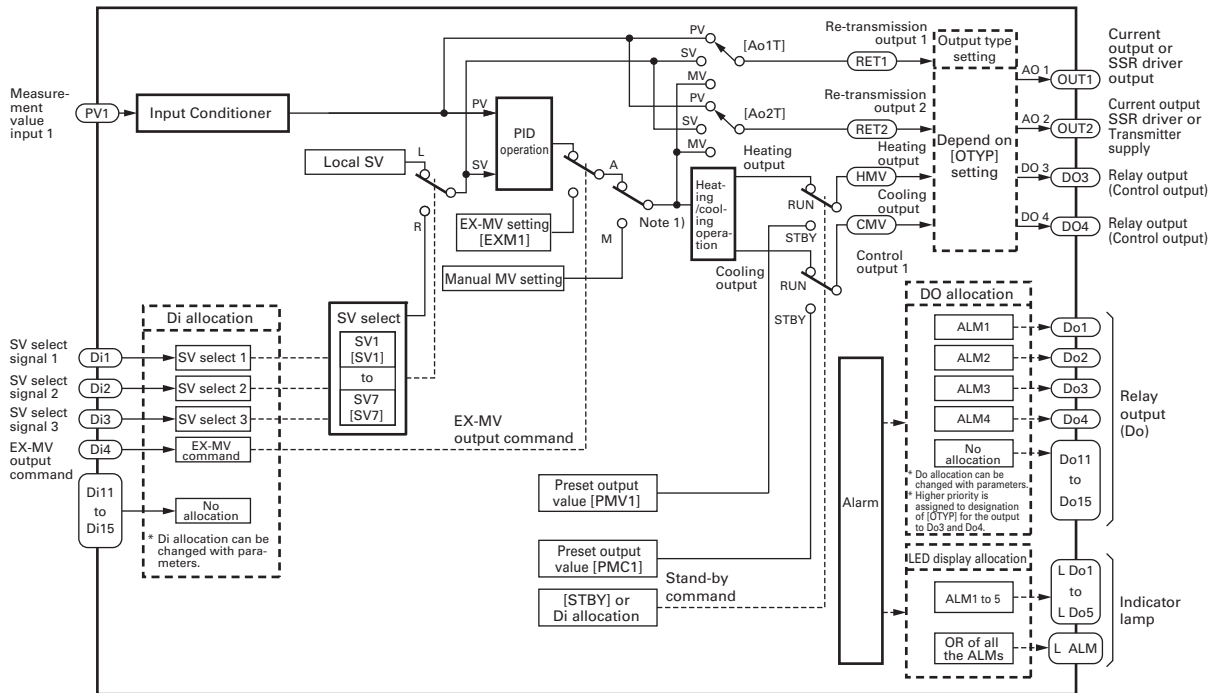

3-2 Setting input

Make the setting of each input of PV1, PV2, and Ai1.
Parameters you have to make the setting are shown below.

<PV1 input>

| Parameter symbol | | Meaning |
|------------------|--------------|--|
| $P\bar{v}1F$ | Pv1F (Ch8-1) | Measurement value input (PV1) full scale setting |
| $P\bar{v}1b$ | Pv1b (Ch8-2) | Measurement value input (PV1) base scale setting |
| $P\bar{v}1d$ | Pv1d (Ch8-3) | Measurement value input (PV1) decimal point position setting |
| $P\bar{v}1T$ | Pv1T (Ch8-4) | Measurement value input (PV1) input type setting |
| $P\bar{v}1U$ | Pv1U (Ch8-5) | Measurement value input (PV1) unit setting |

<PV2 input>

| Parameter symbol | | Meaning |
|------------------|---------------|--|
| $P\bar{v}2F$ | Pv2F (Ch8-14) | Measurement value input (PV2) full scale setting |
| $P\bar{v}2b$ | Pv2b (Ch8-15) | Measurement value input (PV2) base scale setting |
| $P\bar{v}2d$ | Pv2d (Ch8-16) | Measurement value input (PV2) decimal point position setting |
| $P\bar{v}2T$ | Pv2T (Ch8-17) | Measurement value input (PV2) input type setting |
| $P\bar{v}2U$ | Pv2U (Ch8-18) | Measurement value input (PV2) unit setting |

<Ai1 input>

| Parameter symbol | | Meaning |
|------------------|---------------|---|
| $Ai1F$ | Ai1F (Ch8-40) | Analog input (Ai1) full scale setting |
| $Ai1b$ | Ai1b (Ch8-41) | Analog input (Ai1) base scale setting |
| $Ai1d$ | Ai1d (Ch8-42) | Analog input (Ai1) decimal point position setting |
| $Ai1T$ | Ai1T (Ch8-43) | Analog input (Ai1) input type setting |

- Subsequent descriptions are given with PV1 taken as example. To use PV2 or Ai1, check the above parameter symbols, and make the setting, following the same procedure.

Note

- To enable the setting, reset the main unit. See section 3-4 “Reset command” for resetting procedure.
Check whether the setting has been enabled with the display and parameter setting on the operation screen.

3. BASIC USAGE

Pv1F Measurement value input (PV1) full scale (Setting range: -19999 to 99999)

Pv1b Measurement value input (PV1) base scale (Setting range: -19999 to 99999)

[Description]

- Set the upper limit Pv1F (Ch8-1) and the lower limit Pv1b (Ch8-2) of the measurement range.
- Select decimal point position with Pv1d (Ch8-3), and input type with Pv1T (Ch8-4).
- See the following table for details of input range.
- To use Pv2 and Ai1, set Pv2F (Ch8-14), Pv2b (Ch8-15), Ai1F (Ch8-40), and Ai1b (Ch8-41), following the same procedure.

| Input Type | | Measurement Range (°C) | Measurement Range (°F) |
|---------------------------|--------|------------------------|------------------------|
| Resistance bulb (RTD) IEC | Pt100Ω | 0 to 150 | 32 to 302 |
| | | 0 to 300 | 32 to 572 |
| | | 0 to 500 | 32 to 932 |
| | | 0 to 600 | 32 to 1112 |
| | | -50 to 100 | -58 to 212 |
| | | -100 to 200 | -148 to 392 |
| | | -150 to 600 | -238 to 1112 |
| | | -150 to 850 | -238 to 1562 |

- To use Zener barrier for RTD input, user adjustment (section 5-9) is required.

Note 1)

R thermocouple 0 to 500°C } Proper values may not
 B thermocouple 0 to 400°C } be displayed within
 these ranges due to the
 sensor's characteristics.

Note 2) When using at the settings below the minimum range stated in the table above, the input accuracy is not guaranteed.









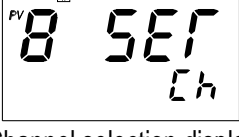

Note 3) In the -50%FS to +50%FS display, values under -199.99 will not be displayed.

| Input Type | | Measurement Range (°C) | Measurement Range (°F) |
|--------------|---|--|------------------------|
| Thermocouple | J | 0 to 400 | 32 to 752 |
| | J | 0 to 1000 | 32 to 1832 |
| | K | 0 to 400 | 32 to 752 |
| | K | 0 to 800 | 32 to 1472 |
| | K | 0 to 1200 | 32 to 2192 |
| | R | 0 to 1600 | 32 to 2912 |
| | B | 0 to 1800 | 32 to 3272 |
| | S | 0 to 1600 | 32 to 2912 |
| | T | -200 to 200 | -328 to 392 |
| | T | -200 to 400 | -328 to 752 |
| | E | 0 to 800 | 32 to 1472 |
| | E | -200 to 800 | -328 to 1472 |
| | PR40/20 | 0 to 1800 | 32 to 3272 |
| | N | 0 to 1300 | 32 to 2372 |
| | PL-II | 0 to 1300 | 32 to 2372 |
| WRe5-26 | 0 to 2300 | 32 to 4172 | |
| DC voltage | 1 to 5V DC 0 to 5V DC 0 to 10V DC 0 to 10mV DC 0 to 50mV DC | -19999 to 99999 (Scaling is possible) | |
| DC current | 4 to 20mA DC 0 to 20mA DC | | |

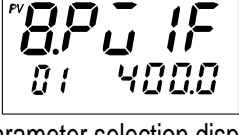
Note

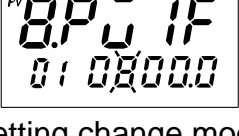
- To enable the setting, reset the main unit. See section 3-4 "Reset command" for resetting procedure.
 Check whether the setting has been enabled with the display and parameter setting on the operation screen.

[Setting example] Changing scale to "0 to 800"

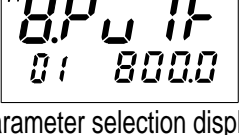
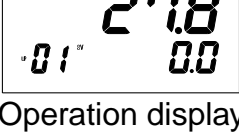
| Display | Operation procedure |
|--|---|
|  <p>Operation display</p> | <p>1. Check that the operation display is shown.</p> |
|  <p>Channel selection display</p> | <p>2. Press the SEL key, and the channel selection display appears, displaying <i>P51</i>.</p> |
|  <p>Channel selection display</p> | <p>3. Press the  key to display <i>8 5EF</i>.</p> |
|  <p>Parameter selection display</p> | <p>4. Press the SEL or the  key, and <i>8.P0 IF</i> appears and the parameter selection display is shown.</p> |
|  <p>Setting change mode</p> | <p>5. Press the SEL or the  key to make the setting flicker, and set the value to <i>08000</i> using the , , or the  key.</p> |
|  <p>Parameter selection display</p> | <p>6. Press the SEL key to register the setting.</p> |
|  <p>Operation display</p> | <p>7. Press the DISP key once to return to the parameter selection display. Press it again to return to the operation display.</p> |

Note

- To enable the setting, reset the main unit. See section 3-4 "Reset command" for resetting procedure. Check whether the setting has been enabled with the display and parameter setting on the operation screen.

3. BASIC USAGE

Pv1d Measurement value input (PV1) decimal point position (Setting range: 0 to 3)

[Description]

- Select the decimal point position of the measurement input value (PV1).

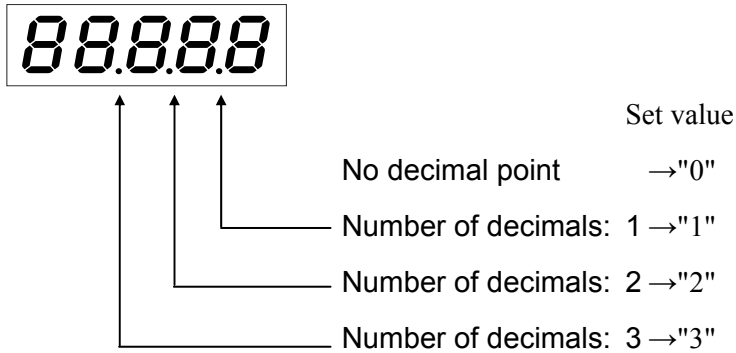











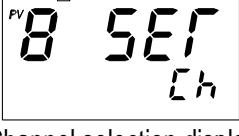

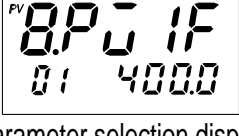
- To use PV2 or Ai1, set Pv2d (Ch8-16) or Ai1d (Ch8-42), following the same procedure.

Note

- To enable the setting, reset the main unit. See section 3-4 "Reset command" for resetting procedure. Check whether the setting has been enabled with the display and parameter setting on the operation screen.

[Setting example] Selecting 2 decimal places

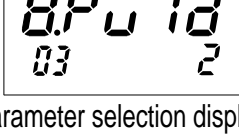
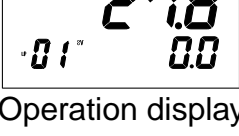
| Display | Operation procedure |
|--|---|
|  <p>Operation display</p> | <p>1. Check that the operation display is shown.</p> |
|  <p>Channel selection display</p> | <p>2. Press the SEL key, and the channel selection display appears, displaying <i>P51</i>.</p> |
|  <p>Channel selection display</p> | <p>3. Press the  key to display <i>B SEF</i>.</p> |
|  <p>Parameter selection display</p> | <p>4. Press the SEL or the  key, and <i>8.PC IF</i> appears and the parameter selection display is shown.</p> |
|  <p>Parameter selection display</p> | <p>5. Press the  key to display <i>8.PC Id</i>.</p> |
|  <p>Setting change mode</p> | <p>6. Press the SEL or the  key to make the setting flicker, and set the value to <i>00002</i> using the , , or the  key.</p> |
|  <p>Parameter selection display</p> | <p>7. Press the SEL key to register the setting.</p> |
|  <p>Operation display</p> | <p>8. Press the DISP key once to return to the parameter selection display. Press it again to return to the operation display.</p> |

3. BASIC USAGE

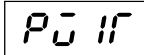

Setting input type of measurement value input (PV1) (Setting range: 0 to 27)

[Description]

- Specify input type.
- See the following table for details of input type and setting (input code).





| Input Type | Code |
|--|--------------------------------------|
| Resistance bulb | |
| <ul style="list-style-type: none"> • Pt100Ω (IEC) | 1 |
| Thermocouple | |
| <ul style="list-style-type: none"> • J • K • R • B • S • T • E • PR40/20 | 2 3 4 5 6 7 8 9 |

| Input Type | Code |
|--|----------------------------|
| <ul style="list-style-type: none"> • N • PL-II • WRe5-26 | 12 13 14 |
| DC voltage | |
| <ul style="list-style-type: none"> • 1 to 5 V DC • 0 to 5 V DC • 0 to 10 V DC • 0 to 10 mV DC • 0 to 50 mV DC | 16 17 18 19 20 |
| DC current | |
| <ul style="list-style-type: none"> • 4 to 20 mA DC • 0 to 20 mA DC | 26 27 |

*For Ai1, only DC voltage (code 16 to 18) settings are possible.

- To use PV2 or Ai1, set Pv2T (Ch8-17) or Ai1T (Ch8-43), following the same procedure.

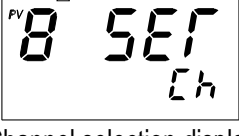
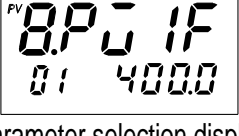
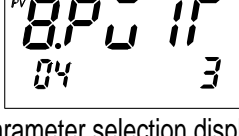
[Setting example] Selecting thermocouple J input

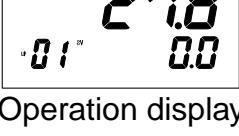
| Display | Operation procedure |
|--|--|
|  <p>Operation display</p> | <p>1. Check that the operation display is shown.</p> |
|  <p>Channel selection display</p> | <p>2. Press the [SEL] key, and the channel selection display appears, displaying <i>P51</i>.</p> |
|  <p>Channel selection display</p> | <p>3. Press the [▽] key to display <i>8 5EF</i>.</p> |
|  <p>Parameter selection display</p> | <p>4. Press the [SEL] or the [▶] key, and <i>8.PC IF</i> appears and the parameter selection display is shown.</p> |
|  <p>Parameter selection display</p> | <p>5. Press the [▽] key to display <i>8.PC IF</i>.</p> |
|  <p>Setting change mode</p> | <p>6. Press the [SEL] or the [▶] key to make the setting flicker, and set the value to <i>00002</i> using the [▶], [▲], or the [▽] key.</p> |
|  <p>Parameter selection display</p> | <p>7. Press the [SEL] key to register the setting.</p> |
|  <p>Operation display</p> | <p>8. Press the [DISP] key once to return to the parameter selection display. Press it again to return to the operation display.</p> |













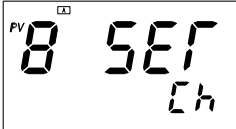

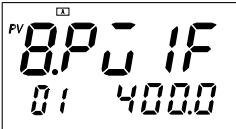
3. BASIC USAGE

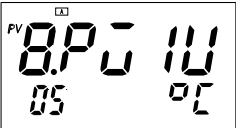
PV U Selecting the unit of measurement value input (PV1) (Setting range: non, °F, °C)

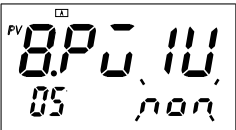
[Description]

- Select a measurement unit from the following.
 - non : No unit
 - °F : °F unit
 - °C : °C unit
- To use PV2, set Pv2U (Ch8-18), following the same procedure.

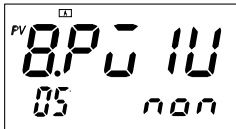
[Setting example] Changing the unit from °C to non

| Display | Operation procedure |
|--|---|
|  <p>Operation display</p> | <p>1. Check that the operation display is shown.</p> |
|  <p>Channel selection display</p> | <p>2. Press the SEL key, and the channel selection display appears, displaying <i>P51</i>.</p> |
|  <p>Channel selection display</p> | <p>3. Press the  key to display <i>B 5EF</i>.</p> |
|  <p>Parameter selection display</p> | <p>4. Press the SEL or the  key, and <i>8.PC IF</i> appears and the parameter selection display is shown.</p> |
|  <p>Parameter selection display</p> | <p>5. Press the  key to display <i>8.PC IU</i>.</p> |
|  <p>Setting change mode</p> | <p>6. Press the SEL or the  key to make the setting flicker, and set the value to <i>non</i> using the , , or the  key.</p> |
|  <p>Parameter selection display</p> | <p>7. Press the SEL key to register the setting.</p> |
|  <p>Operation display</p> | <p>8. Press the DISP key once to return to the parameter selection display. Press it again to return to the operation display.</p> |

3-3 Setting output type





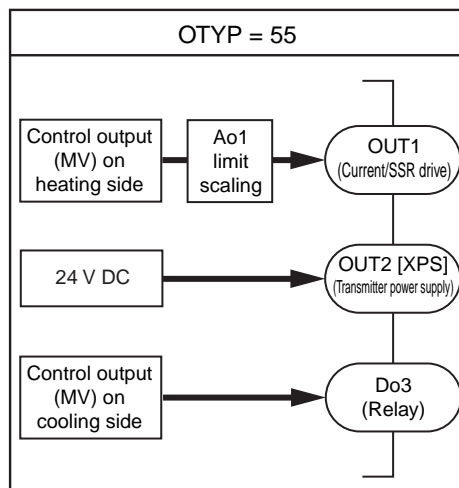
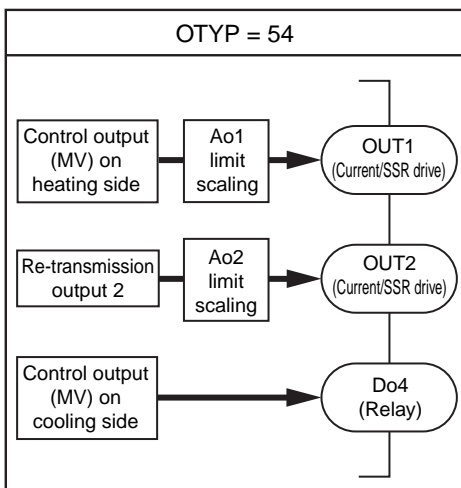
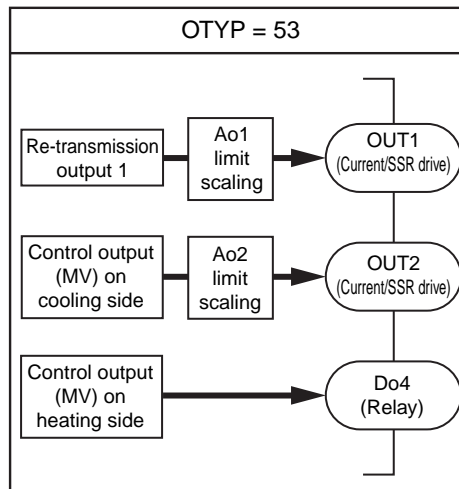
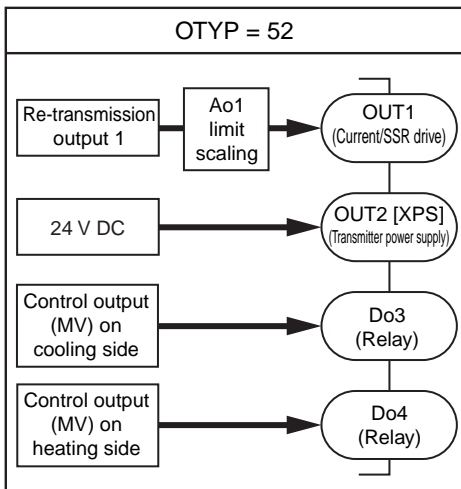
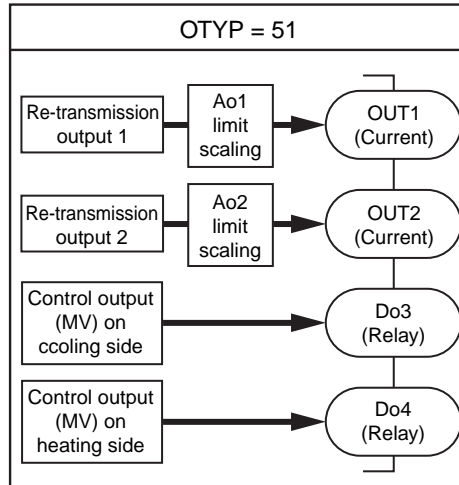
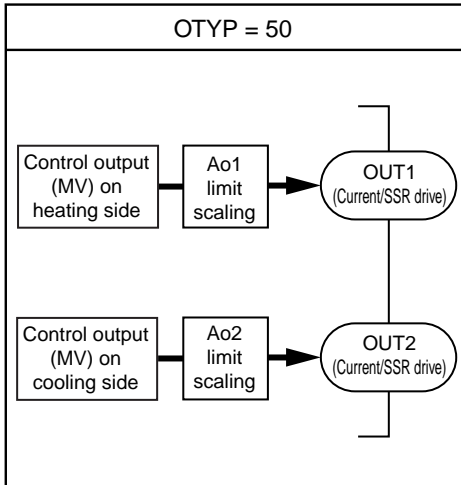

oTYP Selecting output type (Setting range: 50 to 55)

[Description]

- Select a control output type according to applications.
- See the following figure for details of each output type.

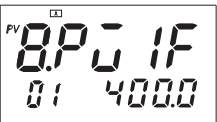
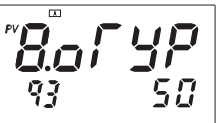

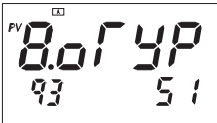
[Setting example] Changing the setting so that both the relay as control output and 2 points of current output as re-transmission output (2 points) can be used

| Display | Operation procedure |
|--|---|
|  <p>Operation display</p> | <p>1. Check that the operation display is shown.</p> |
|  <p>Channel selection display</p> | <p>2. Press the [SEL] key, and the channel selection display appears, displaying <i>P51</i>.</p> |
|  <p>Channel selection display</p> | <p>3. Press the [▽] key to display <i>8 SEF</i>.</p> |
|  <p>Parameter selection display</p> | <p>4. Press the [SEL] or the [▶] key, and <i>8PU IF</i> appears and the parameter selection display is shown.</p> |
|  <p>Parameter selection display</p> | <p>5. Press the [▽] key to display <i>8ofYP</i>.</p> |
|  <p>Setting change mode</p> | <p>6. Press the [SEL] or the [▶] key to make the setting flicker, and set the value to <i>0005</i> using the [▶], [▲], or the [▽] key.</p> |
|  <p>Parameter selection display</p> | <p>7. Press the [SEL] key to register the setting.</p> |
|  <p>Operation display</p> | <p>8. Press the [DISP] key once to return to the parameter selection display. Press it again to return to the operation display.</p> |













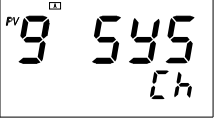

3-4 Reset command

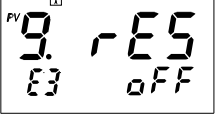
$rE5$ Resetting the main unit (Setting range: ON, OFF)

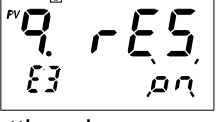
[Description]

- Selecting ON to reset the main unit.
- To enable parameters selected for Ch8, Ch9, ChB, and Ch2 (rEv1), reset the main unit or turn on the power again.

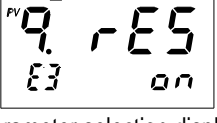
[Setting example] Resetting

| Display | Operation procedure |
|--|--|
|  <p>Operation display</p> | <p>1. Check that the operation display is shown.</p> |
|  <p>Channel selection display</p> | <p>2. Press the SEL key, and the channel selection display appears, displaying <i>PS1</i>.</p> |
|  <p>Channel selection display</p> | <p>3. Press the  key to display <i>9 545</i>.</p> |
|  <p>Parameter selection display</p> | <p>4. Press the SEL or the  key, and <i>9PRS1</i> appears and the parameter selection display is shown.</p> |
|  <p>Parameter selection display</p> | <p>5. Press the  key to display <i>9 rES</i>.</p> |
|  <p>Setting change mode</p> | <p>6. Press the SEL or the  key to make the setting flicker, and set the value to <i>on</i> using the , , or the  key.</p> |
|  <p>Parameter selection display</p> | <p>7. Press the SEL key to register the setting.</p> |
|  <p>Operation display</p> | <p>8. “WAIT RESET” appears and the bar graph comes on. After resetting is completed, the operation display automatically appears.</p> <p>* Resetting takes approx. 10 seconds.</p> |

3-5 Outline of function of heating/cooling control type

About PID control parameters

In heating/cooling control type PID operation, the PID combination on the heating side and that of cooling side are switched according to the result of previous operation (MV). The threshold value of switching the PID combination is fixed to 50% of MV ($MV=50\%$).

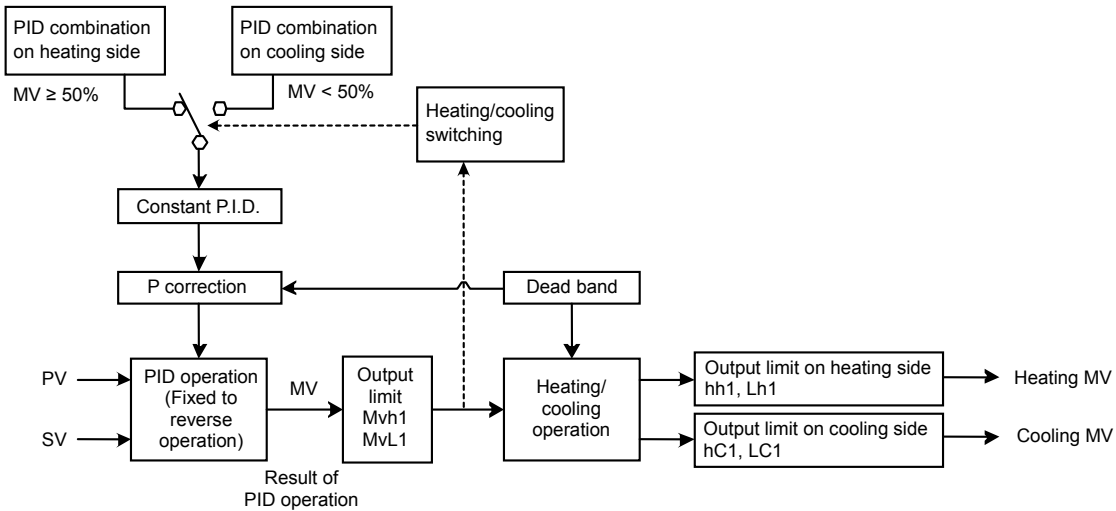

[Note]

- Operation is performed without performing integration either on heating or cooling side when I (heating side) or I (cooling side) is set to 0. BAL is used both for heating output and cooling output.
- Even if P is set to 0 ($P=0$) when heating/cooling control is performed, ON/OFF control is not carried out, but control operation is performed with P set to 0.1 ($P=0.1$).
(To perform 3-position control, allocate deviation alarm to Do3, 4.)

Heating/cooling output operation

The result of PID operation is output divided both to heating and cooling sides.

db 1 Dead band function (Setting range: -100 to 50%)





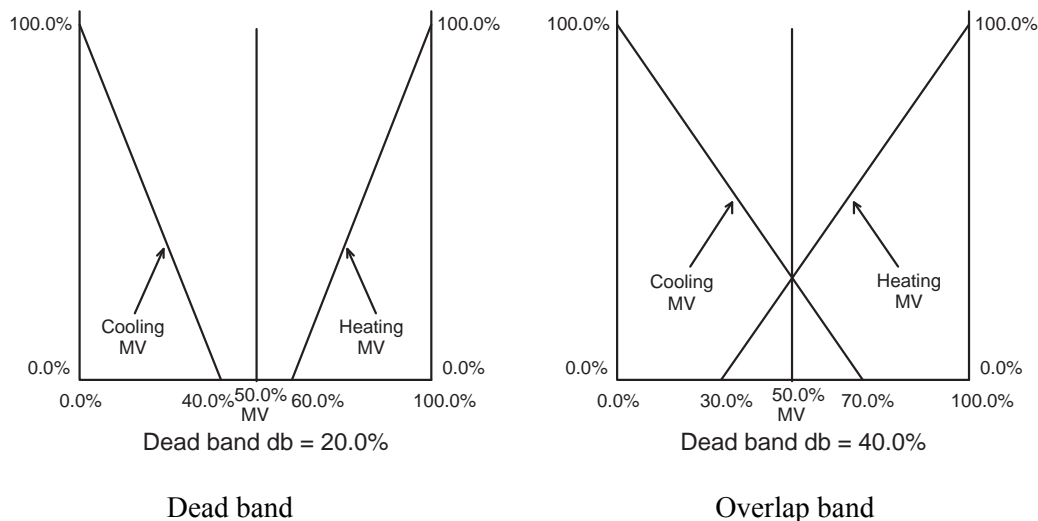





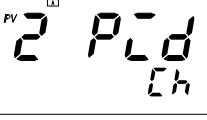

[Description]

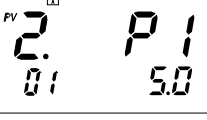
In heating/cooling control, the output on (both the heating and cooling sides) can be overlapped, or a dead band can be provided. This function operates as shown by the following figure according to the setting.

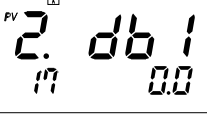
**[Note]**

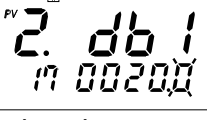
- Set positive value (0 to 55%) for the dead band, and negative value (-100 to 0%) for the overlap band.

[Setting example] Changing dead band from 0% to 20%

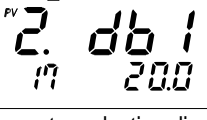
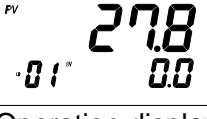
| Display | Operation procedure |
|--|---|
|  <p>Operation display</p> | <p>1. Check that the operation display is shown.</p> |
|  <p>Channel selection display</p> | <p>2. Press the [SEL] key, and the channel selection display appears, displaying <i>P51</i>.</p> |
|  <p>Channel selection display</p> | <p>3. Press the  key to display <i>2 Pcd</i>.</p> |
|  <p>Parameter selection display</p> | <p>4. Press the [SEL] or the  key, and <i>2 P1</i> appears and the parameter selection display is shown.</p> |
|  <p>Parameter selection display</p> | <p>5. Press the  key to display <i>2 db1..</i></p> |
|  <p>Setting change mode</p> | <p>6. Press the [SEL] or the  key to make the setting flicker, and set the value to <i>200</i> using the , , or the  key.</p> |
|  <p>Parameter selection display</p> | <p>7. Press the [SEL] key to register the setting.</p> |
|  <p>Operation display</p> | <p>8. Press the [DISP] key once to return to the parameter selection display. Press it again to return to the operation display.</p> |

PMV1 Output volume setting function on standby heating side (Setting range: -25.0 to 125.0)











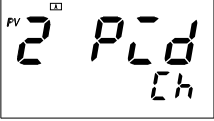

PMC1 Output volume setting function on standby cooling side (Setting range: -25.0 to 125.0)

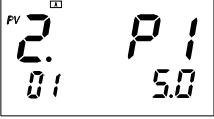
[Description]

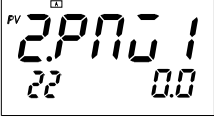
The output volume on the heating side PMV1 (Ch2-22) and that on the cooling side PMC1(Ch2-37) can be specified independently of each other in control standby mode.

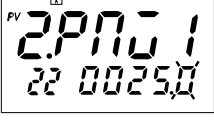
3. BASIC USAGE

[Setting example] Changing the output on heating side from 20.0 to 25.0

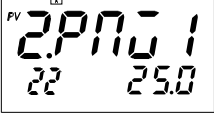
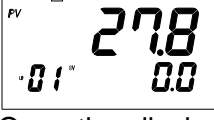
| Display | Operation procedure |
|--|---|
|  <p>Operation display</p> | <p>1. Check that the operation display is shown.</p> |
|  <p>Channel selection display</p> | <p>2. Press the SEL key, and the channel selection display appears, displaying P51.</p> |
|  <p>Channel selection display</p> | <p>3. Press the  key to display 2 Pcd.</p> |
|  <p>Parameter selection display</p> | <p>4. Press the SEL or the  key, and 2 P1 appears and the parameter selection display is shown.</p> |
|  <p>Parameter selection display</p> | <p>5. Press the  key to display 2 Pn01.</p> |
|  <p>Setting change mode</p> | <p>6. Press the SEL or the  key to make the setting flicker, and set the value to 25.0 using the , , or the  key.</p> |
|  <p>Parameter selection display</p> | <p>7. Press the SEL key to register the setting.</p> |
|  <p>Operation display</p> | <p>8. Press the DISP key once to return to the parameter selection display. Press it again to return to the operation display.</p> |

hh1 Upper limit setting on operation output heating side (Setting range: -25.0 to 125.0%)

Lh1 Lower limit setting on operation output heating side (Setting range: -25.0 to 125.0%)

hc1 Upper limit setting on operation output cooling side (Setting range: -25.0 to 125.0%)

lc1 Lower limit setting on operation output cooling side (Setting range: -25.0 to 125.0%)

[Description]

- The upper limit hh1 (Ch2-11) and the lower limit Lh1 (Ch2-12) on the heating side, and the upper limit Hc1 (Ch2-28) and the lower limit LC1 (Ch2-29) on the cooling side can be limited independently to each other.

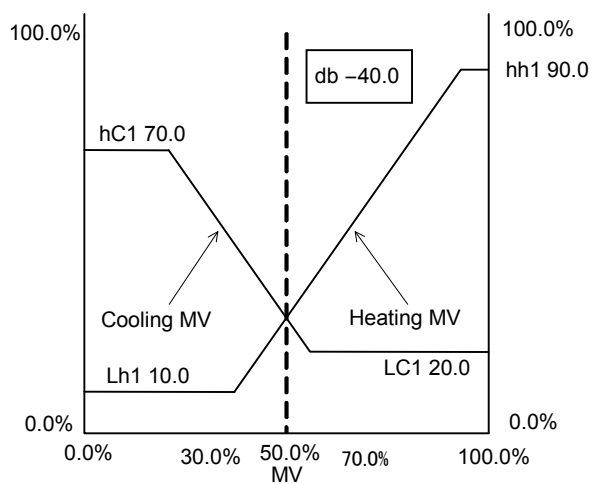











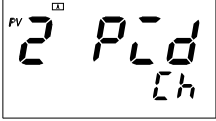

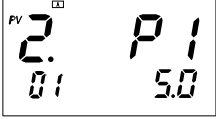

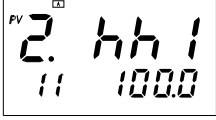
[Note]

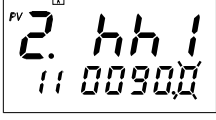
- Output limit cannot be made while auto tuning is performed or in standby state.

3. BASIC USAGE

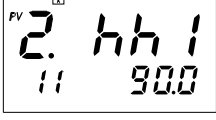
[Setting example] Setting the upper limit output on heating side to 90%

| Display | Operation procedure |
|--|---|
|  <p>Operation display</p> | <p>1. Check that the operation display is shown.</p> |
|  <p>Channel selection display</p> | <p>2. Press the SEL key, and the channel selection display appears, displaying <i>P51</i>.</p> |
|  <p>Channel selection display</p> | <p>3. Press the  key to display <i>2 Pcd</i>.</p> |
|  <p>Parameter selection display</p> | <p>4. Press the SEL or the  key, and <i>2 P1</i> appears and the parameter selection display is shown.</p> |
|  <p>Parameter selection display</p> | <p>5. Press the  key to display <i>2hh1</i>.</p> |
|  <p>Setting change mode</p> | <p>6. Press the SEL or the  key to make the setting flicker, and set the value to <i>900</i> using the , , or the  key.</p> |
|  <p>Parameter selection display</p> | <p>7. Press the SEL key to register the setting.</p> |
|  <p>Operation display</p> | <p>8. Press the DISP key once to return to the parameter selection display. Press it again to return to the operation display.</p> |

Ld1 Setting output limiter type on heating side (Setting range: 0 to 3)

LdC1 Setting output limiter type on cooling side (Setting range: 0 to 3)

[Description]

Whether the value should be limited or exceeded (scale out) (125%, -25%) when the limit setting of cooling output or heating output is reached can be selected.

If scale out setting is made, the minimum ON or OFF time can be created when relay output is made.

The function operates as shown by the following figure according to the Ld1 (Ch2-38) and LdC1 (ch2-39) setting.

| Output on heating side | | |
|------------------------|-------------|-------------|
| Ld1 (Ch2-38) | Upper limit | Lower limit |
| 0 | 125% | -25% |
| 1 | 125% | Limit |
| 2 | Limit | -25% |
| 3 | Limit | Limit |

| Output on cooling side | | |
|------------------------|-------------|-------------|
| LdC1 (Ch2-39) | Upper limit | Lower limit |
| 0 | 125% | -25% |
| 1 | 125% | Limit |
| 2 | Limit | -25% |
| 3 | Limit | Limit |

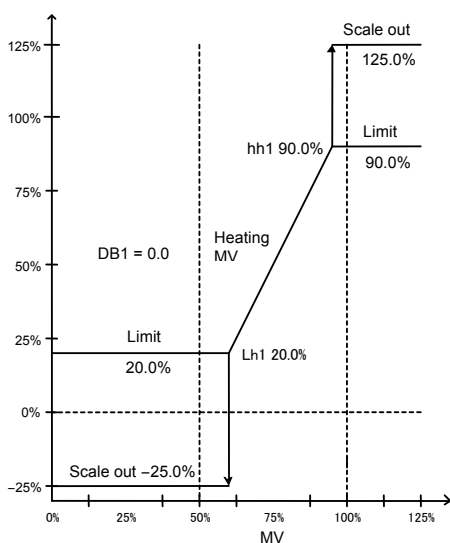

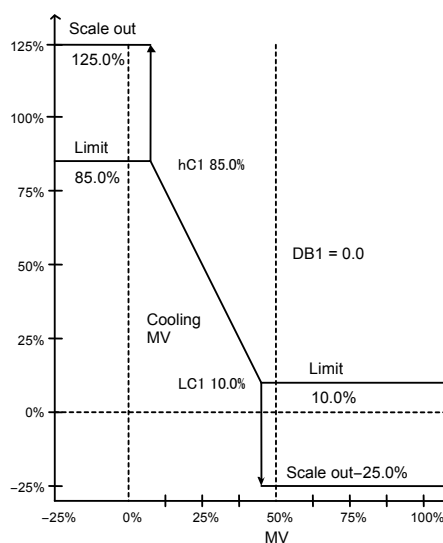

Example of output limit on heating side
(hh1 = 90.0%)
(Lh1 = 20.0%)



Example of output limit on cooling side
(hC1 = 85.0%)
(LC1 = 10.0%)

3. BASIC USAGE

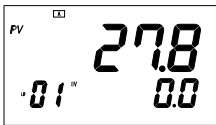
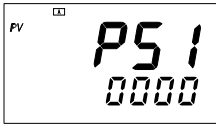
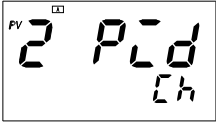
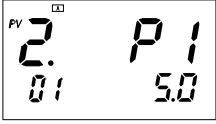
[Setting example] Setting the limiter type at normal output to upper:125% and lower:limit (Ldl=1)

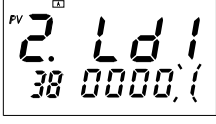
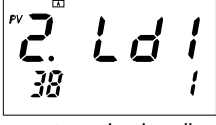
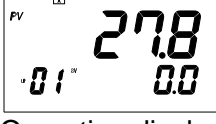
| Display | Operation procedure |
|--|--|
|  <p>Operation display</p> | <p>1. Check that the operation display is shown.</p> |
|  <p>Channel selection display</p> | <p>2. Press the [SEL] key, and the channel selection display appears, displaying <i>P51</i>.</p> |
|  <p>Channel selection display</p> | <p>3. Press the [▽] key to display <i>2 Pld</i>.</p> |
|  <p>Parameter selection display</p> | <p>4. Press the [SEL] or the [▶] key, and <i>2 P1</i> appears and the parameter selection display is shown.</p> |
|  <p>Parameter selection display</p> | <p>5. Press the [▽] key to display <i>2Ldl</i>.</p> |
|  <p>Setting change mode</p> | <p>6. Press the [SEL] or the [▶] key to make the setting flicker, and set the value to <i>1</i> using the [▶], [▲], or the [▽] key.</p> |
|  <p>Parameter selection display</p> | <p>7. Press the [SEL] key to register the setting.</p> |
|  <p>Operation display</p> | <p>8. Press the [DISP] key once to return to the parameter selection display. Press it again to return to the operation display.</p> |

rEÜ1 Control action on heating side (Setting range: NRML, REV)

rEÜ1 Control action on cooling side (Setting range: NRML, REV)

[Description]

- Heating output rE1 (Ch2-20) and cooling output rC1 (Ch2-35) can be switched independently between normal and reverse action.

There are two control action, normal and reverse.







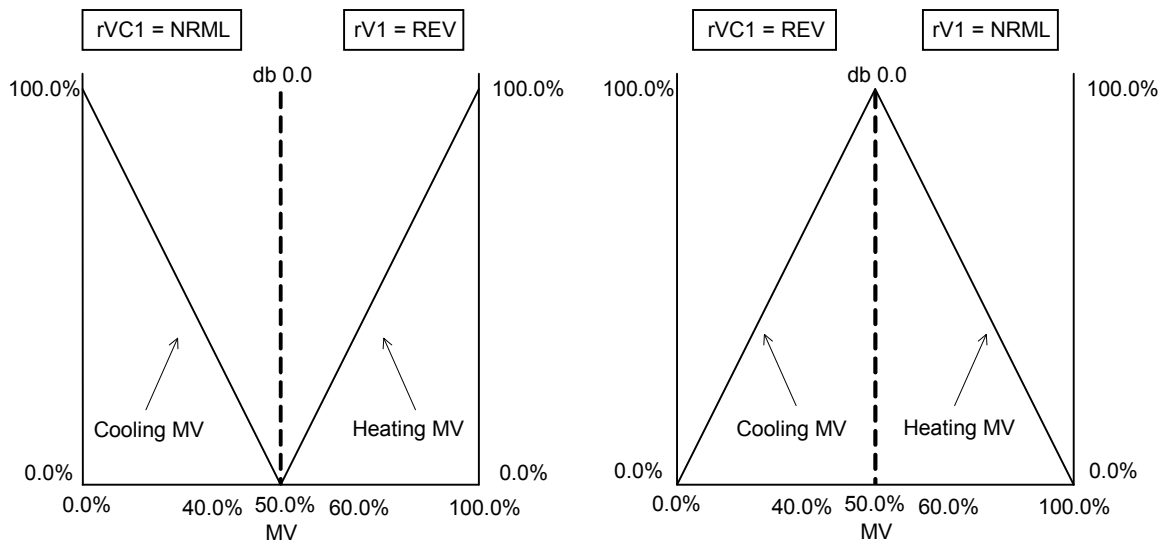





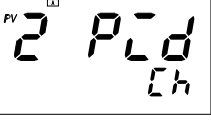

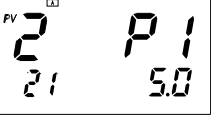
NRML (Normal action): If the measurement (PV) exceeds the set value (SV), the control output increases.

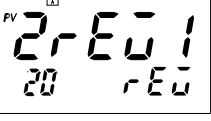
REV (Reverse action): If the measurement (PV) reduces to less than the set value (SV), the control output increases.

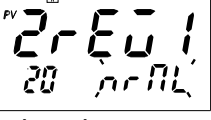
| Control action | Application |
|----------------------|-----------------|
| NRML (Normal action) | Cooling control |
| REV (Reverse action) | Heating control |

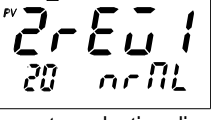

[Setting example] Changing the control actuation direction on heating side from REV to NRML

| Display | Operation procedure |
|--|--|
|  <p>Operation display</p> | <p>1. Check that the operation display is shown.</p> |
|  <p>Channel selection display</p> | <p>2. Press the SEL key, and the channel selection display appears, displaying <i>P51</i>.</p> |
|  <p>Channel selection display</p> | <p>3. Press the  key to display <i>2 Pcd</i>.</p> |
|  <p>Parameter selection display</p> | <p>4. Press the SEL or the  key, and <i>2 P1</i> appears and the parameter selection display is shown.</p> |
|  <p>Parameter selection display</p> | <p>5. Press the  key to display <i>2-REV1</i>.</p> |
|  <p>Setting change mode</p> | <p>6. Press the SEL or the  key to make the setting flicker, and set the value to <i>nrml</i> using the , , or the  key.</p> |
|  <p>Parameter selection display</p> | <p>7. Press the SEL key to register the setting.</p> |
|  <p>Operation display</p> | <p>8. Press the DISP key once to return to the parameter selection display. Press it again to return to the operation display.</p> |

FC1 Proportion cycle on heating side of control output (MV) (Setting range: 1 to 150 sec)

FCC1 Proportion cycle of cooling side of control output (MV) (Setting range: 1 to 150 sec)

[Description]

- The setting is applicable to relay output and SSR drive output.
- While input is kept within the proportional band, output is turned ON/OFF at fixed intervals, which is called proportion cycle.
By making the proportion cycle time shorter, ON-OFF switching time of the operation unit is made shorter, which allows delicate control.

In the case of contact output

The higher the output frequency is, the more delicate control is assured, but service life of contact and operation unit is made shorter. Adjust the proportion cycle time to acquire balance between controllability and service life.











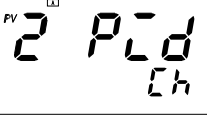

Example: 30 sec

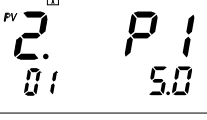
In the case of SSR drive output

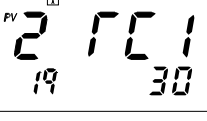
If there is no trouble with the operation unit, select short time setting.

Example: 1 sec

[Setting example] Changing the proportion cycle on heating side from 30 sec to 20 sec

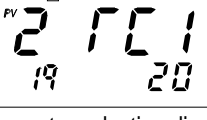
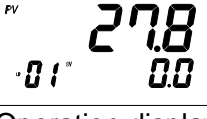
| Display | Operation procedure |
|--|--|
|  <p>Operation display</p> | <p>1. Check that the operation display is shown.</p> |
|  <p>Channel selection display</p> | <p>2. Press the SEL key, and the channel selection display appears, displaying <i>P51</i>.</p> |
|  <p>Channel selection display</p> | <p>3. Press the  key to display <i>2 Pcd</i>.</p> |
|  <p>Parameter selection display</p> | <p>4. Press the SEL or the  key, and <i>2 P1</i> appears and the parameter selection display is shown.</p> |
|  <p>Parameter selection display</p> | <p>5. Press the  key to display <i>2 P1</i>.</p> |
|  <p>Setting change mode</p> | <p>6. Press the SEL or the  key to make the setting flicker, and set the value to <i>00020</i> using the , , or the  key.</p> |
|  <p>Parameter selection display</p> | <p>7. Press the SEL key to register the setting.</p> |
|  <p>Operation display</p> | <p>8. Press the DISP key once to return to the parameter selection display. Press it again to return to the operation display.</p> |









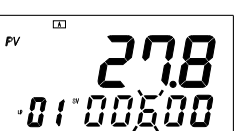

3-6 Setting the set value (SV)

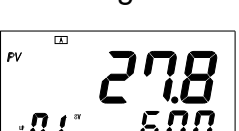
Setting the set value (SV)

[Description]

- Set value (SV) is the target value of the control.
- The upper limit value and the lower limit value of the setting can be set with Sh1 (Ch2-7) and SL1 (Ch2-8).

[Setting example] Changing the set value (SV) from 0.0°C to 60.0°C _____

| Display | Operation procedure |
|--|--|
|  <p>Operation display</p> | <p>1. Check that “SV 00 ” is shown on the operation display.</p> |
|  <p>SV change mode</p> | <p>2. Press the  key to make the SV flicker.</p> |
|  <p>Operation display</p> | <p>3. Set the SV value to 00600 using the , , or the  key.</p> <p>4. Press the  key to complete the operation.</p> |
| | <p>* If the [DISP] key is pressed while the setting is flickering, or no operation status continues for 10 seconds or longer, the value being changed is canceled.</p> <p>* The SV can also be changed without making the value flicker by pressing the  key. Just change the value using the  or the  key.</p> |

[Note]

- Setting value (SV) can not be changed during Ramp/soak operation.

3. BASIC USAGE

Sh 1

SV upper limit value (Setting range: -25 to 125%FS)

SL 1

SV lower limit value (Setting range: -25 to 125%FS)

[Description]

- Set the settable range of set value (SV).
- The SV upper and lower limit values, Sh1 (Ch2-7) and SL1 (Ch2-8), can be set within the range of Pv1 scale from Pv1F (Ch8-1) to Pv1b (Ch8-2). (See the following figure.)

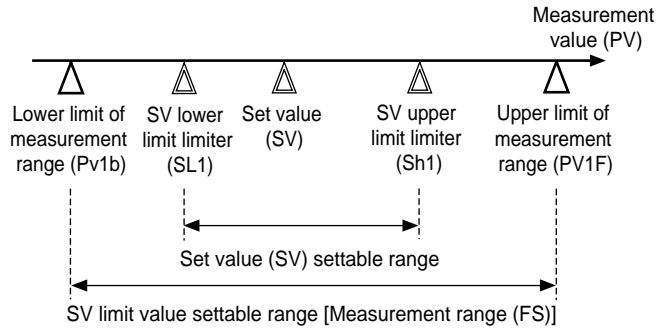

[Note]

- Be sure to set the following parameters before setting Sh1 (Ch2-7) and SL1 (Ch2-8) parameters.
 - Measurement range upper limit setting Pv1F (Ch8-1)
 - Measurement range lower limit setting Pv1b (Ch8-2)
 - Decimal point position Pv1d (Ch8-3)
- After changing Pv1F (Ch8-1), Pv1b (Ch8-2), and Pv1d (Ch8-3) parameters, reset the controller, and then set Sh1 (Ch2-7) and SL1 (Ch2-8) parameters.
- Set the limit values so that Sh1 (Ch2-7) becomes equal or larger than SL1 (Ch2-8).

3-7 AT (Auto tuning)

AT

Auto tuning function (Setting range: OFF, ON1)

ATP1

Setting auto tuning method (Setting range:NRML, LPV)

[Description]

- The controller automatically measures, calculates, and sets PID constant, which is called auto tuning. Perform auto tuning after setting of input range (Pv1F (Ch8-1), Pv1b (Ch8-2), Pv1d (Ch8-3)), set value (SV), and proportion cycle TC1 (Ch2-19) and TCC1 (Ch2-34) is completed.
- When auto tuning is normally completed, the automatically set PID parameter value is maintained even if the power is turned off. If the power is turned off during the process of auto tuning, start again from the beginning. (PID value does not change.)
- Since ON-OFF operation (2-position operation) is performed during auto tuning, PV may fluctuate greatly depending on the process. Do not perform auto tuning for the processes where great fluctuation of PV is not allowed. Do not perform auto tuning, either, for the processes where the response is quick, such as pressure control or flow rate control.
- If auto tuning is not completed in 4 hours, it may not be performed properly. Check input/output wiring and parameters such as control output (forward, reverse) and input sensor type.
- If input range (Pv1F (Ch8-1), Pv1b (Ch8-2), and Pv1d (Ch8-3)) is changed or the operation of control target is changed because a great change is made to the SV, perform auto tuning again.

| Parameter | Description |
|------------------|--|
| Ch E ATP1 | Auto tuning type NRML: Standard type (with reference to SV) LPV: Low PV type (With reference to SV -10%FS) |
| Ch I PLFn | Palette No. used for control (Reflect the result of AT.) 0: Local PID 1 to 7: Palettes No. 1 to 7 |

(1) Standard type (ATP1=NRML)

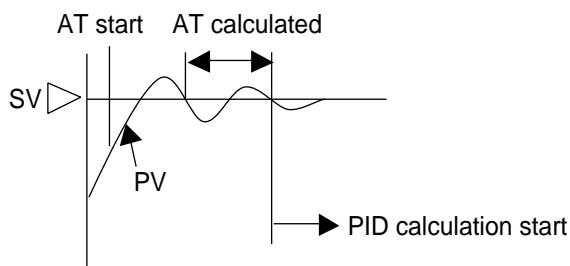

(2) Low PV type (ATP1=LPV)

Overshoot at the time of tuning is reduced.

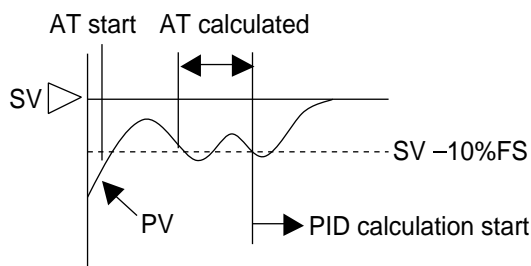

3. BASIC USAGE

▪ Auto tuning system

(1) Standard type (ATP1=NRML)

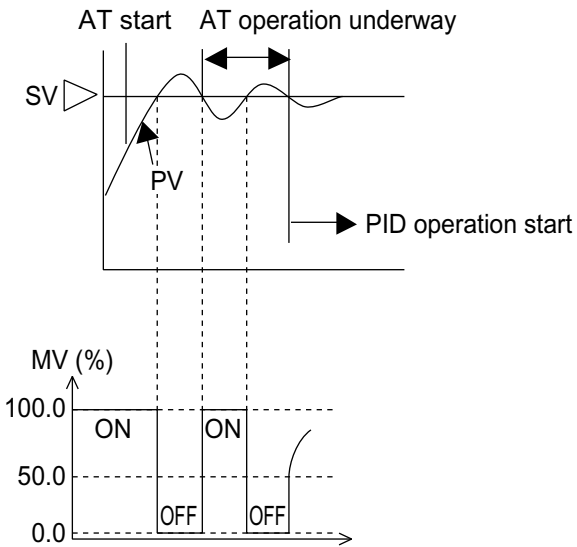

(2) Low PV type (ATP1=LPV)

Overshoot at the time of tuning is reduced.

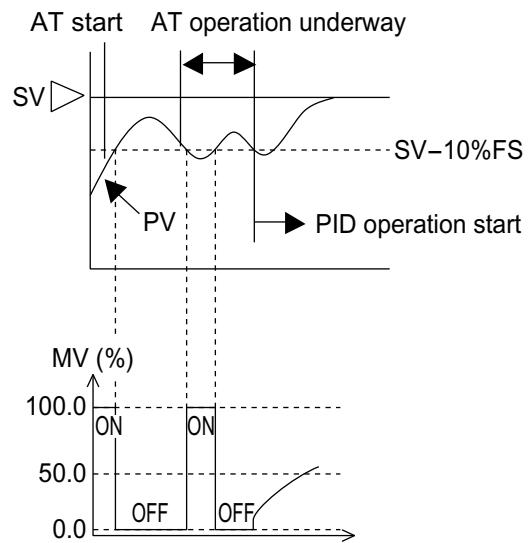

▪ Control output system

When heating side is in reverse action and cooling side in normal action

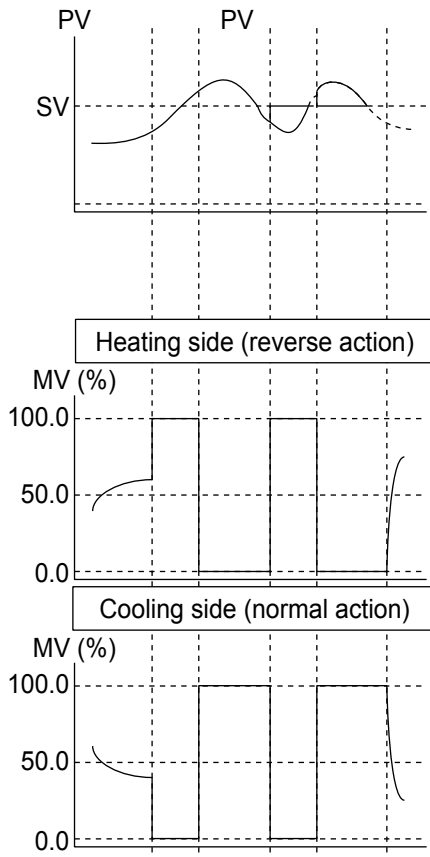



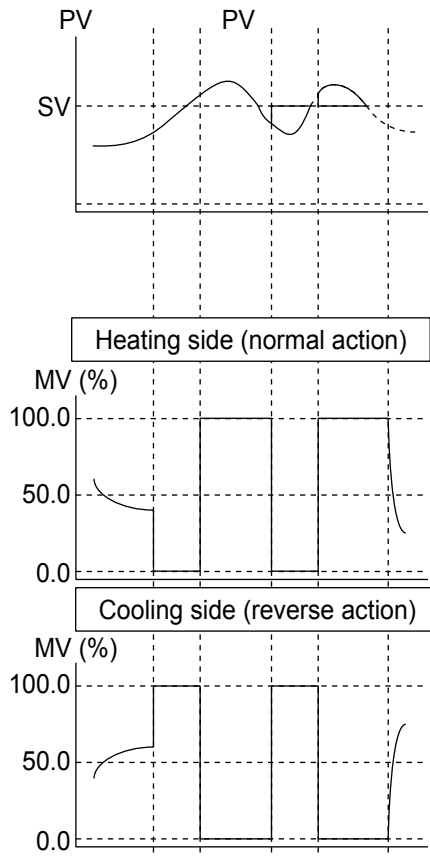











When heating side is in normal action and cooling side in reverse action

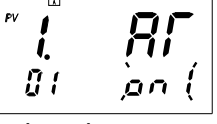

* The output both on the heating and the cooling sides become 0% and 100% while auto tuning is performed.

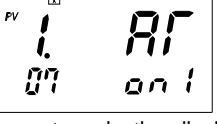
[Setting example] Performing auto tuning

| Display | Operation procedure |
|--|---|
|  <p>Operation display</p> | <p>1. Check that the operation display is shown.</p> |
|  <p>Channel selection display</p> | <p>2. Press the [SEL] key, and the channel selection display appears, displaying <i>PS1</i>.</p> |
|  <p>Channel selection display</p> | <p>3. Press the  key to display <i>1 oPE</i>.</p> |
|  <p>Parameter selection display</p> | <p>4. Press the [SEL] or the  key, and <i>1-EN1</i> appears and the parameter selection display is shown.</p> |
|  <p>Parameter selection display</p> | <p>5. Press the  key to display <i>1 AF</i>.</p> |
|  <p>Setting change mode</p> | <p>6. Press the [SEL] or the  key to make the setting flicker, and set the value to <i>on1</i> using the , , or the  key.</p> |
|  <p>Parameter selection display</p> | <p>7. Press the [SEL] key to register the setting.</p> |
|  <p>Operation display</p> | <p>8. Press the [DISP] key once to return to the parameter selection display. Press it again to return to the operation display.</p> <p>* While auto tuning is in progress, the decimal point of the figure on the right of the lower row is kept flickering. It goes off when auto tuning is completed.</p> |

3-8 Alarm function

1TP to **8TP** Setting alarm type (Setting range: 0 to 38)

[Description]

- Set the operation type of alarms 1 to 8.
- See the following figure for details of alarm type.

| | 1TP to 8TP | Alarm Type | Operation Diagram |
|----------------------|------------|---|-------------------|
| | 0 | No alarm | |
| Absolute value Alarm | 1 | Upper limit absolute | |
| | 2 | Lower limit absolute | |
| | 3 | Upper limit absolute (with hold) | |
| | 4 | Lower limit absolute (with hold) | |
| Deviation Alarm | 5 | Upper limit deviation | |
| | 6 | Lower limit deviation | |
| | 7 | Upper/lower limit deviation | |
| | 8 | Upper limit deviation (with hold) | |
| | 9 | Lower limit deviation (with hold) | |
| | 10 | Upper/lower limit deviation (with hold) | |
| Range Alarm | 11 | Range upper/lower limit deviation | |

Caution The Hold Function:











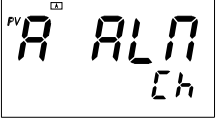

This is an alarm for situations when the alarm does not turn ON immediately, and the value goes outside the range once and then reenters within the range, even when the measured value is within the range of the alarm at the time the power is turned on.

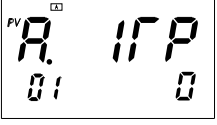
Notes)

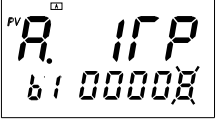
- After changing the alarm type, confirm the alarm setting values. Alarm setting values may change by changing the alarm type, but this is normal.
- Caution: The alarm latch function cannot be used when using the OFF delay timer.
- ALn : Indicates the AL1 (ch1-10) to AL8 (ch1-31) alarm setting values.
- An-H : Indicates the A1-H (ch1-12) to A8-H (ch1-33) alarm setting values.
- An-L : Indicates the A1-L (ch1-11) to A8-L (ch1-32) alarm setting values.
- dLYn : Indicates the 1dLY (chA-4) to 8dLY (chA-39) alarm ON delay setting values.

| | 1TP to 8TP | Alarm Type | Operation Diagram | |
|-------------------------|-------------|--|---|--|
| Upper/lower limit Alarm | 16 | Upper/lower limit absolute | | |
| | 17 | Upper/lower limit deviation | | |
| | 18 | Upper limit absolute Lower limit deviation | | |
| | 19 | Lower limit absolute Upper limit deviation | | |
| | 20 | Upper/lower limit absolute (with hold) | | |
| | 21 | Upper/lower limit deviation (with hold) | | |
| | 22 | Upper limit absolute Lower limit deviation (with hold) | | |
| | 23 | Upper limit deviation Lower limit absolute (with hold) | | |
| | Range Alarm | 24 | Range upper/lower limit absolute | |
| | | 25 | Range upper limit/lower limit deviation | |
| 26 | | Range upper limit absolute Lower limit deviation | | |
| 27 | | Range upper limit deviation Lower limit absolute | | |
| Range Alarm | | 28 | Range upper limit/lower limit absolute (with hold) | |
| | | 29 | Range upper limit/lower limit deviation (with hold) | |
| | 30 | Range upper limit absolute Lower limit deviation (with hold) | | |
| | 31 | Range upper limit deviation Lower limit absolute (with hold) | | |
| Limit | 32 | SV upper/lower limit | | |
| Rate of change | 35 | PV rate of change Upper/lower limit | | |
| Timer | 36 | ON delay timer | | |
| | 37 | OFF delay timer | | |
| | 38 | ON/OFF delay timer | | |

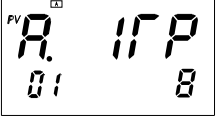
[Setting example] Setting alarm type of Alarm 1 to upper limit deviation (with hold) _____

| Display | Operation procedure |
|--|--|
|  <p>Operation display</p> | <p>1. Check that the operation display is shown.</p> |
|  <p>Channel selection display</p> | <p>2. Press the SEL key, and the channel selection display appears, displaying <i>PS1</i>.</p> |
|  <p>Channel selection display</p> | <p>3. Press the  key to display <i>A ALN</i>.</p> |
|  <p>Parameter selection display</p> | <p>4. Press the SEL or the  key, and <i>A 1/P</i> appears and the parameter selection display is shown.</p> |
|  <p>Setting change mode</p> | <p>5. Press the SEL or the  key to make the setting flicker, and set the value to <i>00000</i> using the , , or the  key.</p> |
|  <p>Parameter selection display</p> | <p>6. Press the SEL key to register the setting.</p> |
|  <p>Operation display</p> | <p>7. Press the DISP key once to return to the parameter selection display. Press it again to return to the operation display.</p> |

3. BASIC USAGE

10P to **80P** Setting alarm options (Setting range: 0000 to 1111)

[Description]

Setting alarm options

- Switching of alarm unit (time) and function setting can be made. (See the following figure).

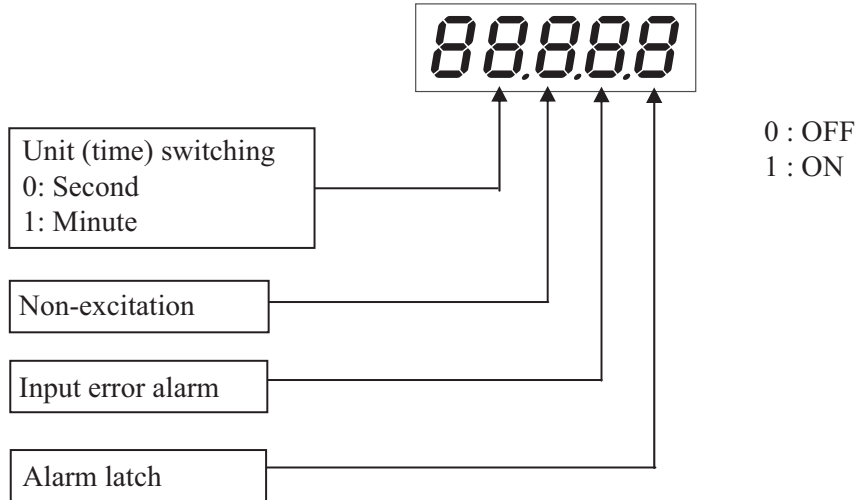

- Unit (time) switching is used for 1dLY (ChA-4) to 8dLY (ChA-39).

What is the excitation/non excitation function?

It is a function that makes the alarm output excited or not excited and outputs to the alarm relay. (When the function is set to ON, the alarm is output when not excited.)

Excitation/non excitation function

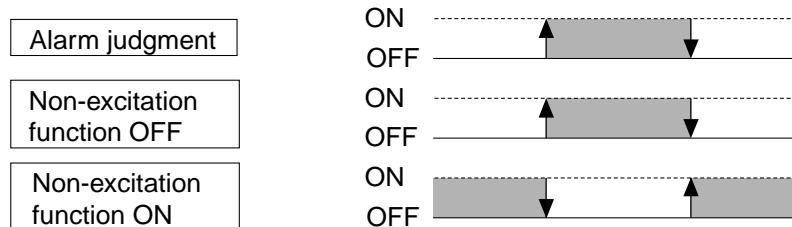

[Note]

If power is turned OFF or during standby, alarm is not output (OFF) even if non-excitation function is set to ON.

What is input error alarm function?













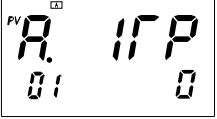

It is a function that turns ON the alarm relay when an error occurs to the main unit.

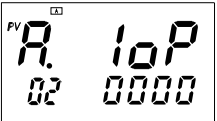
What is alarm latch function?

It is a function that maintains alarm ON status once the alarm is turned ON. Following procedures are available to reset the alarm latch.

- 1) Turn on the power of the controller again.
- 2) Set the alarm latch setting to OFF.
- 3) Reset using the alarm latch reset command LACH (Ch1-8).
- 4) Reset by DI input.
- 5) Reset by communication.

[Setting example] Setting the unit to minute, non-excitation to ON, input error alarm to OFF, and alarm latch to OFF _____

| Display | Operation procedure |
|--|--|
|  <p>Operation display</p> | <p>1. Check that the operation display is shown.</p> |
|  <p>Channel selection display</p> | <p>2. Press the SEL key, and the channel selection display appears, displaying <i>PS1</i>.</p> |
|  <p>Channel selection display</p> | <p>3. Press the  key to display <i>R ALN</i>.</p> |
|  <p>Parameter selection display</p> | <p>4. Press the SEL or the  key, and <i>R 1P</i> appears and the parameter selection display is shown.</p> |
|  <p>Parameter selection display</p> | <p>5. Press the  key to display <i>R 10P</i>.</p> |
|  <p>Setting change mode</p> | <p>6. Press the SEL or the  key to make the setting flicker, and set the value to <i>1100</i> using the , , or the  key.</p> |
|  <p>Parameter selection display</p> | <p>7. Press the SEL key to register the setting.</p> |
|  <p>Operation display</p> | <p>8. Press the DISP key once to return to the parameter selection display. Press it again to return to the operation display.</p> |

3. BASIC USAGE

1dLY to **8dLY** Setting alarm delay time (Setting range: 0 to 9999)

1hYS to **8hYS** Setting alarm hysteresis (Setting range: 0.00 to 50.00%FS)

[Description]

Setting alarm delay time



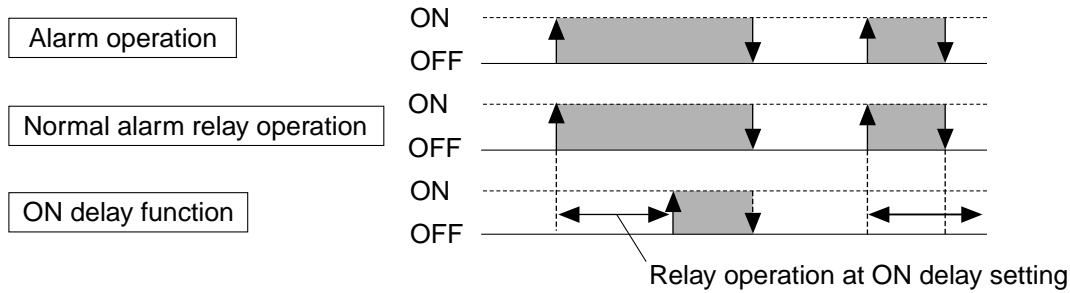







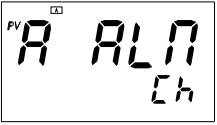

- When alarm ON conditions are met, the alarm is set to ON after selected ON delay time elapses.

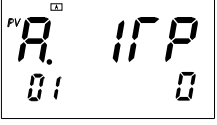

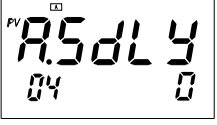
Setting alarm hysteresis

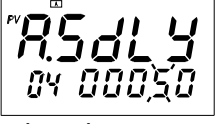
- Set the operation dead band (hysteresis).
- By setting alarm hysteresis, fluctuation of output is prevented and the output is stabilized. Setting can be made according to applications.

[Setting example] Setting delay time of Alarm 5 to 50

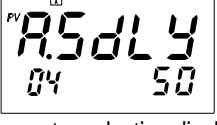
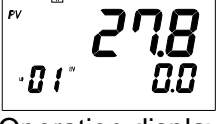
| Display | Operation procedure |
|--|---|
|  <p>Operation display</p> | <p>1. Check that the operation display is shown.</p> |
|  <p>Channel selection display</p> | <p>2. Press the SEL key, and the channel display appears, displaying <i>P51</i>.</p> |
|  <p>Channel selection display</p> | <p>3. Press the  key to display <i>A ALN</i>.</p> |
|  <p>Parameter selection display</p> | <p>4. Press the SEL or the  key, and <i>A IRP</i> appears and the parameter selection display is shown.</p> |
|  <p>Parameter selection display</p> | <p>5. Press the  key to display <i>ASDLY</i>.</p> |
|  <p>Setting change mode</p> | <p>6. Press the SEL or the  key to make the setting flicker, and set the value to <i>00050</i> using the , , or the  key.</p> |
|  <p>Parameter selection display</p> | <p>7. Press the SEL key to register the setting.</p> |
|  <p>Operation display</p> | <p>8. Press the DISP key once to return to the parameter selection display. Press it again to return to the operation display.</p> |

3. BASIC USAGE











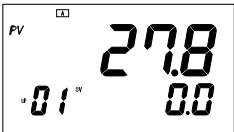

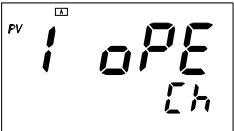

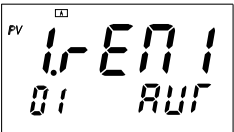
| | | | | | |
|-------------|----|-------------|---------------------------|---|--|
| <i>AL 1</i> | to | <i>AL 8</i> | Alarm setting | } | Setting range: 0 to 100%FS for absolute value alarm, -100 to 100%FS for deviation alarm |
| <i>A1-L</i> | to | <i>A8-L</i> | Alarm lower limit setting | | |
| <i>A1-h</i> | to | <i>A8-h</i> | Alarm upper limit setting | | |

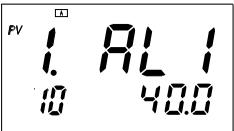
[Description]

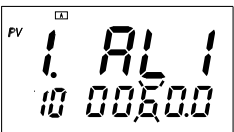
- Set the operation value of alarms from 1 to 8.
- Display/non display status of AL1 (Ch1-10) to AL8 (Ch1-31), A1-L (Ch1-11) to A8-L (Ch1-32), A1-h (Ch1-12) to A8-h (Ch1-33) changes automatically according to the type of alarms selected. (See the following table for details.)

| Setting of 1TP to 8TP | Displayed parameter |
|-----------------------|---------------------|
| 1 to 11, 35 | AL1 to AL8 |
| 16 to 32 | A1-h to A8-h |
| | A1-L to A8-L |

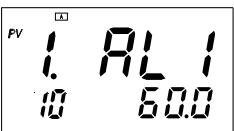
[Setting example] Setting alarm 1 setting to 60.0

| Display | Operation procedure |
|--|--|
|  <p>Operation display</p> | <p>1. Check that the operation display is shown.</p> |
|  <p>Channel selection display</p> | <p>2. Press the SEL key, and the channel selection display appears, displaying <i>P51</i>.</p> |
|  <p>Channel selection display</p> | <p>3. Press the  key to display <i>1oPE</i>.</p> |
|  <p>Parameter selection display</p> | <p>4. Press the SEL or the  key, and <i>1-EN1</i> appears and the parameter selection display is shown.</p> |
|  <p>Parameter selection display</p> | <p>5. Press the  key to display <i>1 AL1</i>.</p> |
|  <p>Setting change mode</p> | <p>6. Press the SEL or the  key to make the setting flicker, and set the value to <i>00600</i> using the , , or the  key.</p> |
|  <p>Parameter selection display</p> | <p>7. Press the SEL key to register the setting.</p> |
|  <p>Operation display</p> | <p>8. Press the DISP key once to return to the parameter selection display. Press it again to return to the operation display.</p> <p>* When 1TP is set to 16-32, AL1 is not displayed. See the table on the previous page.</p> |

3-9 Re-transmission output

Ao1T

Setting output type of re-transmission output 1 (Setting range: PV, SV, MV, DV, AiM, MVRB, TV)

[Description]

- See the following table for details of output type.





| Ao1T | Meaning |
|------|--|
| PV | Measurement value (PV) |
| SV | Set value (SV) |
| MV | Operation output value (MV) |
| DV | Deviation (PV – SV) |
| AiM | Result of Math function (AiM) |
| MVRB | Valve opening feedback (MVRB) ^{Note 1)} |
| TV | Totalizer result value ^{Note 2)} |

- To use output scaling, make the scaling setting of Ao1H (Ch8-66) and Ao1L (Ch8-67).
- To use Ao2, make the setting of Ao2T (Ch8-70), Ao2H (Ch8-72), Ao2L (Ch8-73) in the same way.

Note 1: MVRB cannot be used.

Note 2: If [TV] is selected as re-transmission output type, make rTSC (ChG-21) setting.

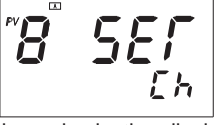
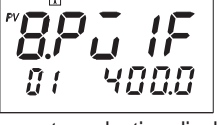
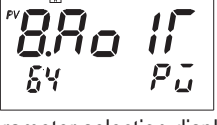
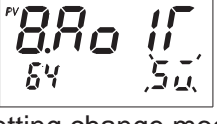
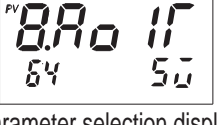
[Setting example] Changing the type of re-transmission output 1 from PV to SV _____

| Display | Operation procedure |
|--|---|
|  <p>Operation display</p> | <p>1. Check that the operation display is shown.</p> |
|  <p>Channel selection display</p> | <p>2. Press the [SEL] key, and the channel selection display appears, displaying <i>PS1</i>.</p> |
|  <p>Channel selection display</p> | <p>3. Press the [▽] key to display <i>8 SET</i>.</p> |
|  <p>Parameter selection display</p> | <p>4. Press the [SEL] or the [▶] key, and <i>8.PC IF</i> appears and the parameter selection display is shown.</p> |
|  <p>Parameter selection display</p> | <p>5. Press the [▽] key to display <i>8.Ro IF</i>.</p> |
|  <p>Setting change mode</p> | <p>6. Press the [SEL] or the [▶] key to make the setting flicker, and set the value to <i>50</i> using the [▶], [▲], or the [▽] key.</p> |
|  <p>Parameter selection display</p> | <p>7. Press the [SEL] key to register the setting.</p> |
|  <p>Operation display</p> | <p>8. Press the [DISP] key once to return to the parameter selection display. Press it again to return to the operation display.</p> |

3. BASIC USAGE

Ao1h Upper limit value of the scale of re-transmission output 1 (Setting range: –130.0% to 130.0%)

Ao1L Lower limit value of the scale of re-transmission output 1 (Setting range: –130.0% to 130.0%)

[Description]

- Set the upper limit value and lower limit value of the scaling of re-transmission output.
- The unit of setting is %.

| Output type | Meaning of setting value [%] | |
|-------------|---|--|
| | When TPLT = 53, 54 | When TPLT = 50, 51 |
| PV/SV/DV | Scale set in Pv1F (Ch8-1), Pv1b (Ch8-2), Pv1d (Ch8-3) | Scale set in UCF1 (Ch8-89), UCb1 (Ch8-90), UCd1 (Ch8-91) |
| AiM | — | Scale set in UCF1 (Ch8-89), UCb1 (Ch8-90), UCd1 (Ch8-91) |
| MV/MVRB | Fixed to 0.0 to 100.0% (output value) | Fixed to 0.0 to 100.0% (output value) |
| TV | Scale of input type selected in Toin (ChG-3) | Scale of input type selected in Toin (ChG-3) |

Note: The following is an example where scales used are PV1F, PV1b, and PV1d. Find the setting using the same expression when using other scales. (Refer also to the setting example shown below.)

$$\text{Setting (\%)} = (A / B) \times 100 (\%)$$

A = The value to be set – Setting of parameter Pv1b (Ch8-2)

B = Setting of parameter Pv1F (Ch8-1) – Setting of Pv1b (Ch8-2)

- When the value of re-transmission output type (SV for example) becomes equal to the setting of Ao1L (Ch8-67), the re-transmission output becomes 0% (output).
- When the value of re-transmission output type (PV for example) becomes equal to the setting of Ao1h (Ch8-66), the re-transmission output becomes 100% (output).
- To use the function for output2, make the setting of Ao2h (Ch8-72) and Ao2L (Ch8-73) in the same way.
- If the scaling upper limit values Ao1h, Ao2h and the lower limit values Ao1L, Ao2L are set in reverse, the output is reversed. (See the following figure.)

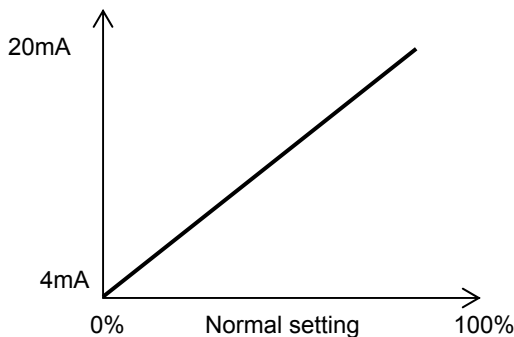

When Ao1L=0.0%, Ao1H=100.0%

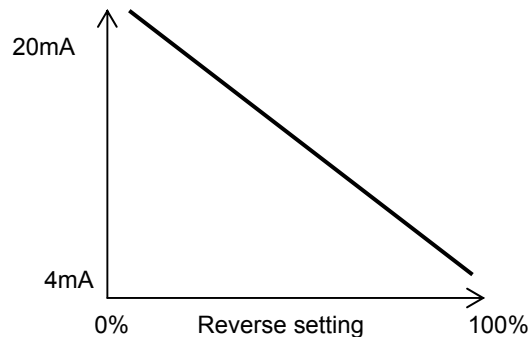











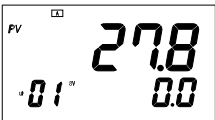
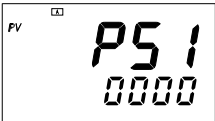
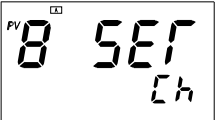

When Ao1L=100.0%, Ao1H=0.0%

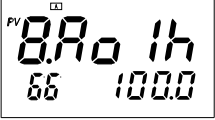
[Setting example] Performing scaling to allow 0% output when PV (value of re-transmission output type) is 100°C, and 100% output when it is 300°C, with the input type of K thermocouple of 0 to 400°C

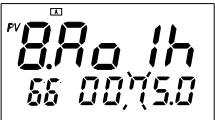









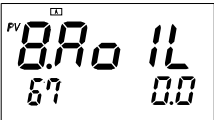

Since measurement range is from 0 to 400°C, Pv1b = 0 (lower limit value of the measurement range), and Pv1F = 400 (upper limit value of the measurement range), the values of A and B in the expression on the previous page are calculated as follows.

$A = (100^\circ\text{C} - 0)$ or $(300^\circ\text{C} - 0)$, $B = 400 - 0 = 400$

- 1) Setting of Ao1L: At what % position is 100°C in 0 to 400°C range? = 25% (= $100 - 0$) / 400×100 [%])
→ Ao1L = 25.0%
- 2) Setting of Ao1h: At what % position is 300°C in 0 to 400°C range? = 75% (= $300 - 0$) / 400×100 [%])
→ Ao1h = 75.0%

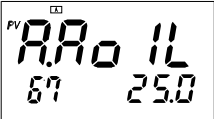
| Display | Operation procedure |
|--|---|
|  <p>Operation display</p> | <ol style="list-style-type: none"> 1. Check that the operation display is shown. |
|  <p>Channel selection display</p> | <ol style="list-style-type: none"> 2. Press the SEL key, and the channel selection display appears, displaying <i>PS1</i>. |
|  <p>Channel selection display</p> | <ol style="list-style-type: none"> 3. Press the  key to display <i>8 SET</i>. |
|  <p>Parameter selection display</p> | <ol style="list-style-type: none"> 4. Press the SEL or the  key, and <i>8P0 IF</i> appears and the parameter selection display is shown. |
|  <p>Parameter selection display</p> | <ol style="list-style-type: none"> 5. Press the  key to display <i>8A0 1h</i>. |
|  <p>Setting change mode</p> | <ol style="list-style-type: none"> 6. Press the SEL or the  key to make the setting flicker, and set the value to <i>0075.0</i> using the , , or the  key. |
|  <p>Parameter selection display</p> | <ol style="list-style-type: none"> 7. Press the SEL key to complete the setting of <i>8A0 1h</i>. <p style="text-align: right;">Continued to the next page.</p> |

3. BASIC USAGE

| Display | Operation procedure |
|--|--|
|  <p>Parameter selection display</p> | <p>8. Press the  key to display <i>8.80 IL</i> .</p> |
|  <p>Setting change mode</p> | <p>9. Press the  or the  key to make the setting flicker, and set the value to <i>0025.0</i> using the , , or the  key.</p> |
|  <p>Parameter selection display</p> | <p>10. Press the  key to complete the setting of <i>8.80 IL</i> .</p> |
|  <p>Operation display</p> | <p>11. Press the  key once to return to the parameter selection display. Press it again to return to the operation display.</p> |











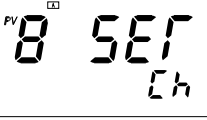

A 1Lh Upper limit value of re-transmission output (Setting range: -25.0% to 105.0%)

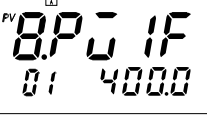
A 1Ll Lower limit value of re-transmission output (Setting range: -25.0% to 105.0%)

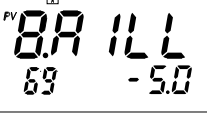
[Description]

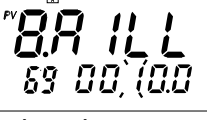
- Set the limit values of re-transmission output.
- When setting Ao2, set A2Lh and A2LL in the same way.

[Setting example] Changing lower limit setting of re-transmission 1 output from -5% to 10%—

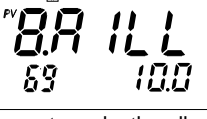
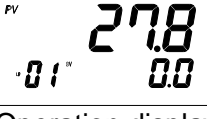
| Display | Operation procedure |
|--|---|
|  <p>Operation display</p> | <p>1. Check that the operation display is shown.</p> |
|  <p>Channel selection display</p> | <p>2. Press the [SEL] key, and the channel selection display appears, displaying <i>P51</i>.</p> |
|  <p>Channel selection display</p> | <p>3. Press the  key to display <i>8 5EF</i>.</p> |
|  <p>Parameter selection display</p> | <p>4. Press the [SEL] or the  key, and <i>8.PC IF</i> appears and the parameter selection display is shown.</p> |
|  <p>Parameter selection display</p> | <p>5. Press the  key to display <i>8A ILL</i>.</p> |
|  <p>Setting change mode</p> | <p>6. Press the [SEL] or the  key to make the setting flicker, and set the value to <i>00 100</i> using the , , or the  key.</p> |
|  <p>Parameter selection display</p> | <p>7. Press the [SEL] key to register the setting.</p> |
|  <p>Operation display</p> | <p>8. Press the [DISP] key once to return to the parameter selection display. Press it again to return to the operation display.</p> |

3-10 Setting communications

STn4 RS485 station No. (Setting range: 0 to 255)

SPd4 RS485 communication speed (Setting range: 96, 192, 384)

biT4 RS485 bit format (Setting range: 8o, 8n, 8E)





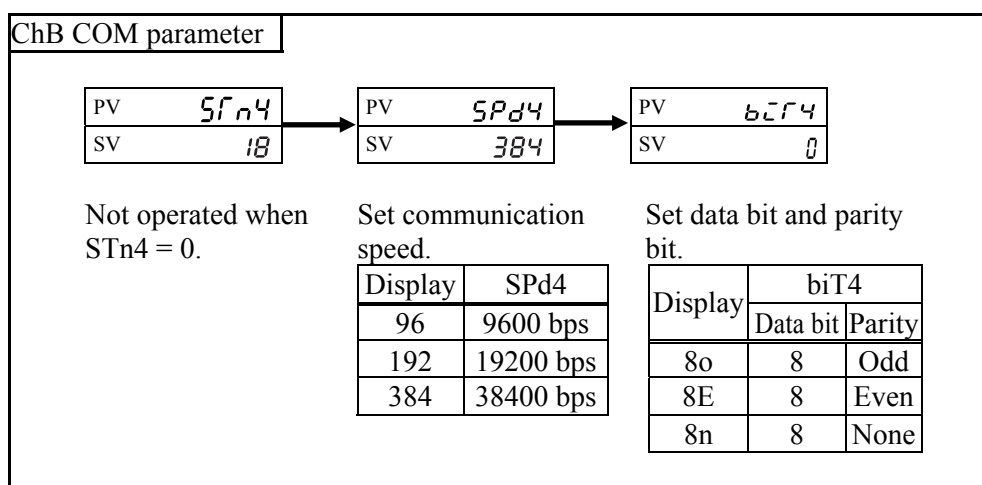







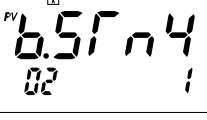

[Description]

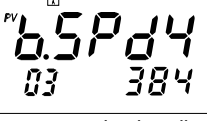
- Reading and writing of internal data are allowed with MODBUS RTU communications.
- See the following figure for details of parameter setting.



- Selected parameters are not enabled unless the power is turned on again. Be sure to reset the instrument or turn the power on again.
- * See “Instruction Manual for Communication Functions (MODBUS)” for details of reading and writing of internal data and communications.

[Setting example] Changing communication speed from 38400bps to 19200bps _____

| Display | Operation procedure |
|--|---|
|  <p>Operation display</p> | <p>1. Check that the operation display is shown.</p> |
|  <p>Channel selection display</p> | <p>2. Press the [SEL] key, and the channel selection display appears, displaying <i>P51</i>.</p> |
|  <p>Channel selection display</p> | <p>3. Press the  key to display <i>b Conf</i>.</p> |
|  <p>Parameter selection display</p> | <p>4. Press the [SEL] or the  key, and <i>b.57n4</i> appears and the parameter selection display is shown.</p> |
|  <p>Parameter selection display</p> | <p>5. Press the  key to display <i>b.5Pd4</i>.</p> |
|  <p>Setting change mode</p> | <p>6. Press the [SEL] or the  key to make the setting flicker, and set the value to <i>192</i> using the , , or the  key.</p> |
|  <p>Parameter selection display</p> | <p>7. Press the [SEL] key to register the setting.</p> |
|  <p>Operation display</p> | <p>8. Press the [DISP] key once to return to the parameter selection display. Press it again to return to the operation display.</p> |

SPd2 PC loader interface (RC232C) communication speed (Setting range: 96, 192, 384)

biT2 PC loader interface (RS232C) bit format (Setting range: 8o, 8n, 8E)





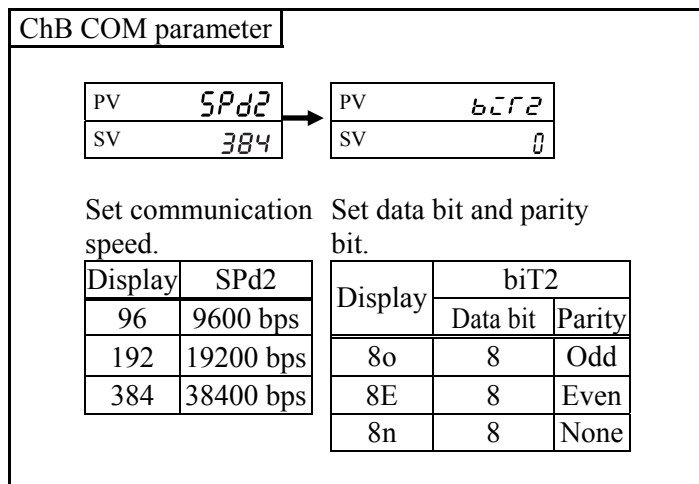







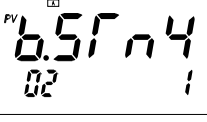

[Description]

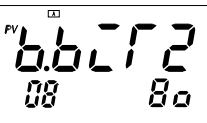
- See the following figure for details of parameter setting.

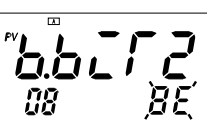

- Selected parameters are not enabled unless the power is turned on again. Be sure to reset the instrument or turn the power on again.

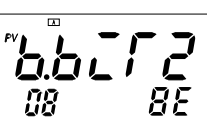
[Setting example] Setting bit format 8o to 8E

| Display | Operation procedure |
|--|--|
|  <p>Operation display</p> | <p>1. Check that the operation display is shown.</p> |
|  <p>Channel selection display</p> | <p>2. Press the SEL key, and the channel selection display appears, displaying <i>P51</i>.</p> |
|  <p>Channel selection display</p> | <p>3. Press the  key to display <i>b Conf</i>.</p> |
|  <p>Parameter selection display</p> | <p>4. Press the SEL or the  key, and <i>b.5Fn4</i> appears and the parameter selection display is shown.</p> |
|  <p>Parameter selection display</p> | <p>5. Press the  key to display <i>b.bCf2</i>.</p> |
|  <p>Setting change mode</p> | <p>6. Press the SEL or the  key to make the setting flicker, and set the value to <i>8E</i> using the , , or the  key.</p> |
|  <p>Parameter selection display</p> | <p>7. Press the SEL key to register the setting.</p> |
|  <p>Operation display</p> | <p>8. Press the DISP key once to return to the parameter selection display. Press it again to return to the operation display.</p> |

4 OPERATION

Operation mode

This instrument can be operated in Auto, Remote, or Manual mode.

The operation method of each mode, operation display, and operation procedures are described below.

● Auto operation

The instrument is automatically operated with the target settings set in the controller.

Target settings can be set on the front panel or with communication.

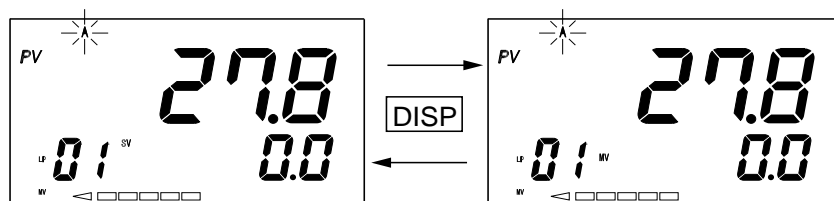

[Mode indicator]

A lights

[PV indicator]

Displays measurement value (PV).

[SV/MV indicator]

Displays set value (SV).

[SV/MV operation]

Settings can be changed on the front panel.

[Mode indicator]

M lights

[PV indicator]

Displays measurement value (PV).

[SV/MV indicator]

Displays operation output (MV).

[SV/MV operation]

Operation output cannot be changed on the front panel.

* See section 4-1 “Auto operation” for details of auto operation procedures.

● Manual operation

An operator manually changes operation output (MV) to operate the instrument.

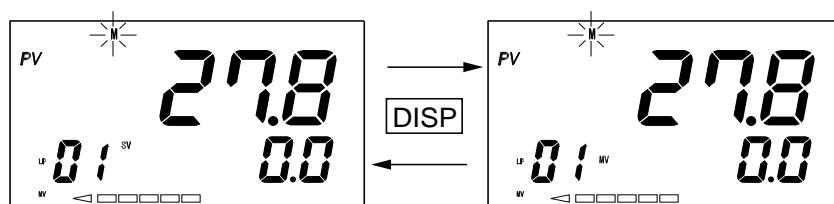

[Mode indicator]

M lights

[PV indicator]

Displays measurement value (PV).

[SV/MV indicator]

Displays set value (SV).

[SV/MV operation]

Settings can be changed in local mode.

[Mode indicator]

M lights

[PV indicator]

Displays measurement value (PV).

[SV/MV indicator]

Displays operation output (MV).

[SV/MV operation]

Settings can be changed on the front panel.

* See section 4-2 “Manual operation” for details of manual operation procedures.

4. OPERATION

● Remote operation

Operation is performed with auxiliary input Ail or the setting of SV selection (SV selectable PID controller type) used as target setting.

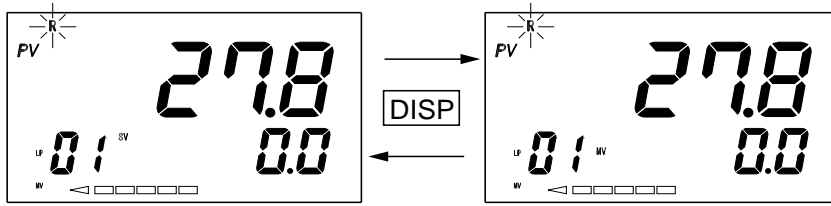

[Mode indicator]

R lights on.

[PV indicator]

Displays measurement value (PV).

[SV/MV indicator]

Displays auxiliary input Ail or target setting of SV selection PID control.

[SV/MV operation]

Target settings cannot be changed.

[Mode indicator]

R lights on.

[PV indicator]

Displays measurement value (PV).

[SV/MV indicator]

Displays operation output (MV).

[SV/MV operation]

Settings can be changed on the front panel.

* See section 4-3 “Remote operation” for details of remote operation procedures.

■ Change between Auto and Manual mode

Changing method: Operation mode can be changed between Auto and Manual using the A/M key on the operation display.
(See section 4-2 “Manual operation” for detailed operation procedures.)

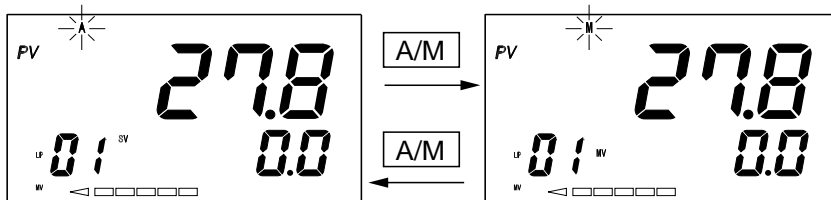

Related functions: [1] Prohibition of change to manual operation: Change to manual operation can be prohibited with A-M1 (Ch9-15) parameter. (See section 5-17 “Manual operation prohibition” for details.)

[2] Operation mode can be switched to Manual by manual command signal with Di input.
(See section 5-10 “Digital input (Di) function” for details.)

Note: Change both from Auto to Manual and Manual to Auto is a balanceless bumpless transfer.

■ Changing between Auto and Remote operations

Changing method : [1] Operation mode can be changed between Auto and Remote with rEM1 (Ch1-1).
(See section 4-3 “Remote operation” for detailed operation procedures.)

[2] Operation mode can be changed between Auto and Remote by operating the dSV key.
(See section 5-13 “Function key” for details.)

[3] The operation mode is automatically changed to Remote by performing SV switching at the time of SV selectable PID controller.

Related functions: [1] Remote operation prohibition function: Remote operation can be prohibited with rihl (Ch9-7) parameter.

[2] Changing with R-ACK signal: The operation mode can be changed to Remote with R-ACK signal from digital input with rAC1 (Ch9-11) setting.
(See section 5-16 “R-ACK function”, and section 5-10 “Digital input (Di) function” for details.)

Note: Change from Remote to Local: Provision of tracking function can be selected with Trk1 (Ch9-23).

Balanceless bumpless transfer when TrK1=On

Balance bumpless transfer when TrK1=Off

Change from Local to Remote: Balance bumpless transfer
(Balance remote SV and local SV while watching dSV display before changing modes.)

Flow of operation mode change

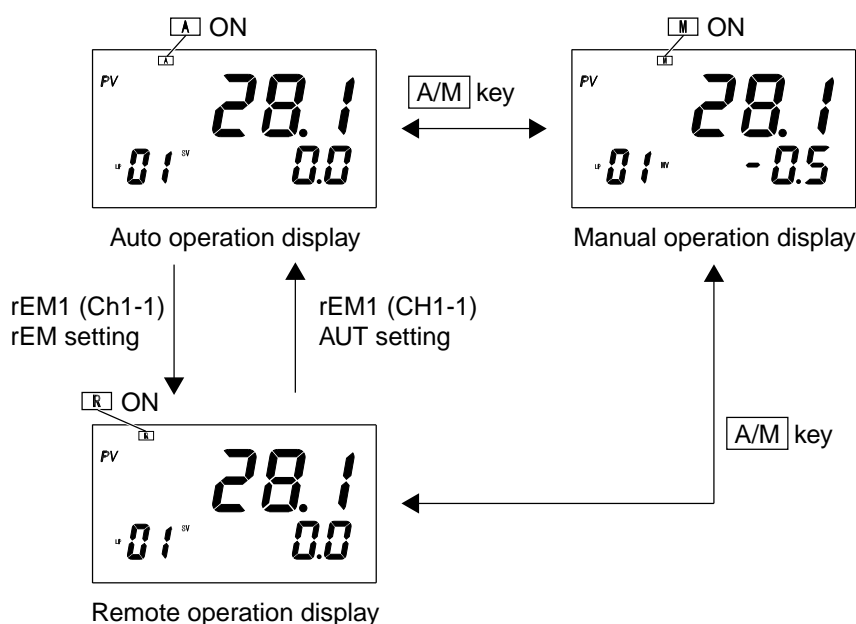

4-1 Auto operation





[Description]

Set value (SV) can be set on the front panel, and the result of PID operation can be output as operation output (MV), which is called “Auto operation.”

The A lamp is kept on during auto operation.

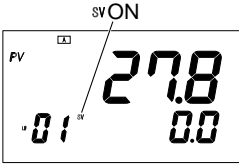
The SV during auto operation is called “Local SV”.

Changing SV

| Display | Operation procedure |
|--|--|
|  <p>Operation display</p> | <p>— Changing SV —</p> <ol style="list-style-type: none"> 1. Check that the “SV” of the SV/MV lamp lights on the operation display. |
|  | <ol style="list-style-type: none"> 2. Press the <input type="checkbox"/> key, and the value of the digit at the far right increases. Press the <input type="checkbox"/> key, and the value of the digit at the far right decreases. The SV value is immediately reflected in this case. |
|  <p>Setting change mode</p> | <ol style="list-style-type: none"> 3. Press the <input type="checkbox"/> key, and the digit at the far right of the SV starts flickering. Press the <input type="checkbox"/> key again while it is flickering, and you can move to the digit you want to change. |
|  | <ol style="list-style-type: none"> 4. When the digit you want to change being flickering, change the setting by pressing the <input type="checkbox"/> and <input type="checkbox"/> keys. |
|  <p>Operation display</p> | <ol style="list-style-type: none"> 5. Press the <input type="checkbox"/>SEL key, and the change of SV is completed, and the setting is reflected. |

Displaying operation output (MV)

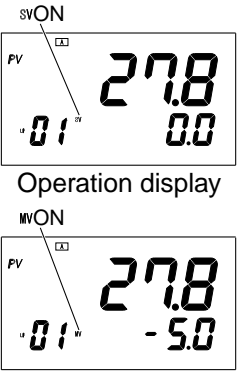
| Display | Operation procedure |
|--|---|
|  <p>Operation display</p> | <p>—Displaying MV —</p> <ol style="list-style-type: none"> 1. Check that the “SV” of the SV/MV lamp lights on the operation display. 2. Press the DISP key while the “SV” lamp is on, and the display changes to MV display. (“MV” lamp comes on.) (Press the DISP key again to return to the SV display operation screen.) |

Changing from Auto (A) operation to Manual (M) operation

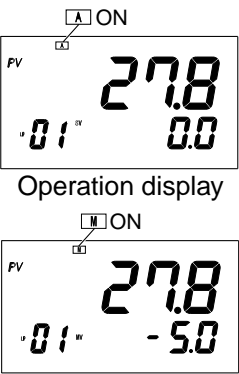
| Display | Operation procedure |
|---|---|
|  <p>Operation display</p> | <ol style="list-style-type: none"> 1. Check that the A lamp lights on the operation display. 2. Press the A/M key while the A lamp is on, and the M lamp comes on, and the operation mode is changed to Manual. (Press the A/M key to return to Auto operation.) |

Note: The operation output (MV) value immediately before the change to Manual operation is displayed when operation mode is changed from Auto to Manual.
The MV value is kept output until the MV setting is changed.



4-2 Manual operation

[Description]

Operation output (MV) can be directly operated by an operator, which is called “Manual operation.” (Setting unit is %.)

The M lamp lights is on during manual operation.

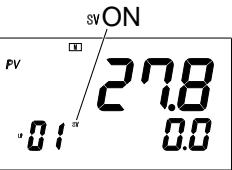
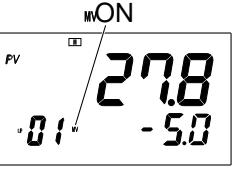
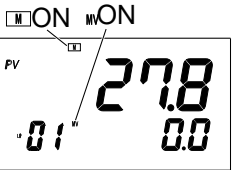
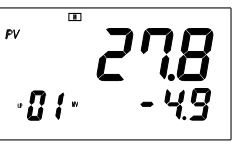
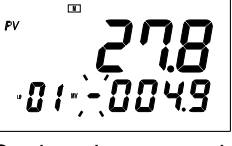
Displaying operation output (MV)

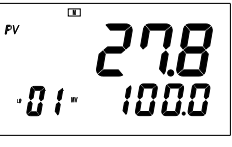
| Display | Operation procedure |
|--|--|
|  <p>Operation display</p> | <p>—Displaying MV—</p> <ol style="list-style-type: none"> 1. Check that “SV” of the SV/MV lamp lights on the operation display. |
|  <p>Operation display</p> | <ol style="list-style-type: none"> 2. Press the DISP key while the “SV” lamp is kept on, and the display changes to MV display. (Press the DISP key again to return to the SV display screen.) |
|  <p>Operation display</p> | <p>—Changing MV—</p> <ol style="list-style-type: none"> 1. Check that the “MV” lamp and M lamp lights on the operation display. |
|  | <ol style="list-style-type: none"> 2. Press the ▲ key, and the value of the digit at the far right increases. Press the ▼ key, and the value of the digit at the far right decreases. The MV value is immediately reflected in this case. Pressing the ▲ key or the ▼ key for 3 seconds accelerates the increase or the decrease. |
|  <p>Setting change mode</p> | <ol style="list-style-type: none"> 3. Press the ▶ key, and the digit at the far right of the MV value starts flickering. Press the ▶ key again while it is flickering, and you can move to the digit you want to change. |
|  | <ol style="list-style-type: none"> 4. When flickering moves to the digit you want to change, change the setting by pressing the ▲ and the ▼ keys. |
|  <p>Operation display</p> | <ol style="list-style-type: none"> 5. Press the SEL key, and the change of MV is completed, and the setting is reflected. |

Changing from Manual (M) to Auto (A) operation

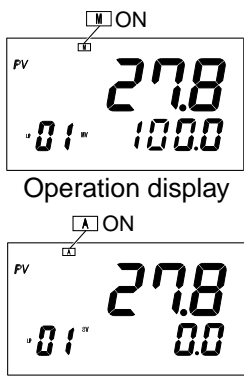
| Display | Operation procedure |
|---|--|
|  <p>The top screenshot shows the display with 'PV' on the left, '27.8' in the center, and '01' and '100.0' at the bottom. A small 'M' lamp icon is lit above the display. Below the screenshot is the text 'Operation display'.</p> <p>The bottom screenshot shows the same display, but the 'A' lamp icon is flickering, and the bottom right value is '0.0'.</p> | <ol style="list-style-type: none"> <li data-bbox="571 360 1326 398">1. Check that the <input type="checkbox"/> M lamp lights on the operation display. <li data-bbox="571 539 1442 689">2. Press the <input type="checkbox"/> A/M key while the <input type="checkbox"/> M lamp is kept on, and the <input type="checkbox"/> A lamp starts flickering and the operation mode is changed to Auto. (Press the <input type="checkbox"/> A/M key again to return to Manual operation.) |

4-3 Remote operation (SV=Auxiliary input Ai1)

REN1 Changing Remote/Auto operation (Setting range: REM, AUT)

[Description]

This instrument can be operated either in “Auto operation” mode, in which SV is set using the keys on the front panel, or “Remote operation” mode, in which SV is set with external settings (remote SV) set by analog auxiliary input signals or SV selection method (see section 4-4 “SV selection function (Remote operation)”).

Change to Remote operation mode can also be made using the Function key allocated by users, or Di remote acknowledge signals (R-ACK) besides using this parameter.

This parameter cannot be used for SV selection method.

* See section 5-16 for details of R-ACK function.

* See section 5-13 for details of Function keys.

To operate the instrument in Remote mode (SV=Auxiliary input Ai1), set the control template (TPLT (Ch8-92)) to “50” or “53” in advance.









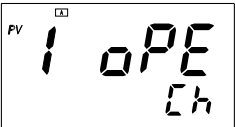

Note: Remote operation can be performed only when “1” is selected for the 7th digit of the code symbols.

• To perform Remote operation

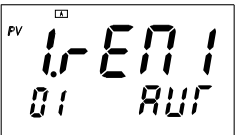
- (1) Set Ai1F, Ai1B, and Ai1D (Ch8-40, 41, 42) to the same value as PV1F, PV1B, and PV1D (Ch8-1, 2, 3) (If PV1 input scale setting and Ai1 input scale setting do not coincide, the value of Ai1 monitor (Ch7-4) and remote SV are not the same.)
- (2) Set Ai1T (Ch8-43) to the voltage range to be input.
- (3) Connect the voltage signal for remote SV to the auxiliary input terminal (Ai1).
- (4) Perform zero point adjustment and span point adjustment of remote SV input as required.
 - Ai1Z (Ch8-45): Parameter for zero point adjustment of remote SV input
 - Ai1S (Ch8-46): Parameter for span point adjustment of remote SV input
 - (See section 5-9 “User adjustment” for details.)
- (5) Change REM1 (Ch1-1) parameter from AUT to REM, and the mode is changed to Remote SV operation mode.
 - (Change can also be made by the Function key or Di.)

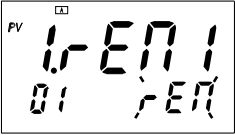
* A1TF (Ch8-50) is the setting for remote SV input filter. Keep the setting to 0.0 (factory-set value) unless the change is inevitable.

[Setting example] Changing operation mode from Auto to Remote

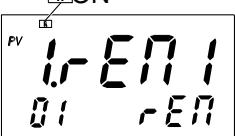
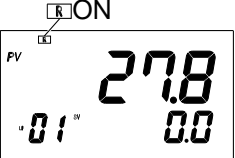
| Display | Operation procedure |
|--|--|
|  <p>Operation display</p> | <p>1. Check that the operation display is shown.</p> |
|  <p>Setting change mode</p> | <p>2. Press the SEL key, and the channel selection display appears, displaying <i>P51</i>.</p> |
|  <p>Setting change mode</p> | <p>3. Press the  key to display <i>1 oPE</i>.</p> |
|  <p>Parameter selection display</p> | <p>4. Press the SEL or the  key, and the parameter selection display appears, displaying <i>1-EN1</i>.</p> |
|  <p>Setting change mode</p> | <p>5. Press the SEL or the  key to make the setting flicker, and set the value to <i>r-EN</i> using the  or the  key.</p> |
|  <p>Parameter selection display</p> | <p>6. Press the SEL key to register the setting.</p> |
|  <p>Operation display</p> | <p>7. Press the DISP key once to return to the parameter selection display. Press it again to return to the operation display.</p> |

[Note]

For changing operation mode from Remote to Auto

- Follow the same procedure to change this parameter from REM to AUT.
- See section 5-19 “SV tracking function” for the SV when the operation mode is changed from Remote to Auto.

4-4 SV selection function (Remote operation)

- Eight kinds of set values (SV), SV1 to 7 of Ch4 (PLT) and local SV, can be selected and controlled with Di1 to 3, which is called SV selection function.
- Set TPLT (Ch8-92) to “51” or “54” to use the SV selection function.
- Select SV, referring to the following table.

| SV No. | Di1 | Di2 | Di3 |
|----------------------|-----|-----|-----|
| SV (Local set value) | OFF | OFF | OFF |
| SV1 (Remote SV) | ON | OFF | OFF |
| SV2 (Remote SV) | OFF | ON | OFF |
| SV3 (Remote SV) | ON | ON | OFF |
| SV4 (Remote SV) | OFF | OFF | ON |
| SV5 (Remote SV) | ON | OFF | ON |
| SV6 (Remote SV) | OFF | ON | ON |
| SV7 (Remote SV) | ON | ON | ON |

[Note]

Operation is carried out in Remote mode when SV1 to 7 is selected.

[Example]

Set SV1 (Ch4-1) of to 50.0, SV2 (Ch4-41) to 60.0, and SV3 (Ch4-81) to 40.0, and the operation can be performed according to the settings of SV1 (for 0 to t_1), SV2 (for t_1 to t_2) and SV3 (for t_2 to t_3).

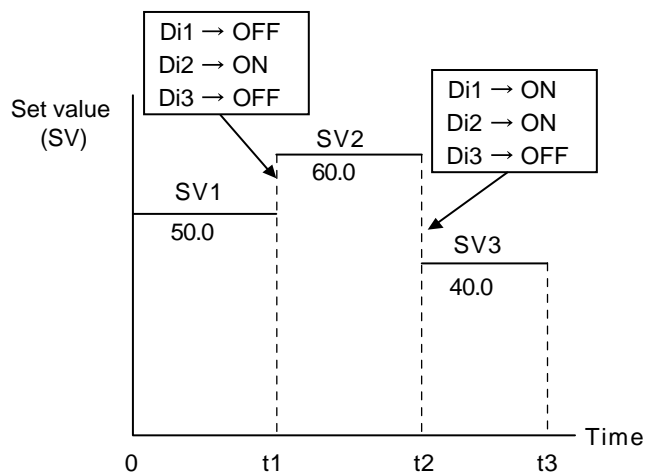

| | |
|-------------------|--|
| Setting range | -25.0 to 125.0%FS (Engineering value setting depends on full scale) (Within the range of the SV limiter if it is set.) |
| Factory-set value | 0.0%FS (Engineering value setting depends on full scale) |

- See section 5-19 “SV tracking function” for the SV when the operation mode is changed from Remote to Auto.

4-5 Standby function

STBY Standby setting (Setting range: ON, OFF)

STbo Operation setting for standby function (Setting range: 0, 1)

PMV1 Output setting for standby function (Setting range: -25.0 to 105.0%)

[Description]

1) Change between RUN/Standby with STby (Ch1-5).

During standby state, all the outputs except for control output (MV) and communication are turned OFF. Control output (MV) becomes designated value.

- The **STBY** lamp is kept on during standby.
(PV and SV display can be turned off with STbo (Ch9-30) setting.)
- See the following table for the status of functions during standby.

| | During standby | Return from standby |
|---------------------------------|---|---|
| Operation output | Outputs value designated by PMV1 / PMC1 | Bumpless restart from PMV1. |
| Alarm output | All outputs are OFF. | — |
| Timer operation | All operations are OFF. | Zero start |
| Hold operation | - | Initial start |
| Latch operation | All operations are OFF. | Initial start (released) |
| Non-excitation output operation | All outputs are OFF. (Non-excitation operations are invalid) | Work in non-excitation operation |
| Communication | Not affected by standby status. | |
| Analog re-transmission output | 0mA | |
| Digital output (Do) | All outputs are OFF. | — |
| Digital input (Di) | — | Status detection: Operated Edge detection: Not operated. |
| Control mode | Not affected by standby status. | |
| Display | Can be selected from ON/OFF | ON |

- Standby setting is maintained even if the power is turned ON/OFF.
- If the instrument is put into standby while auto tuning is carried out, the auto tuning is canceled. PID constant is not updated.

2) Set the operations during standby to STbo.

- See the following table for the operations during standby.

| STBY | STbo setting | Operation during standby | | |
|------|--------------|--|----------------------|---------|
| | | MV output | Output other than MV | Display |
| ON | 0 | Value of PMV1 (Ch2-22) (-25% to 125%) | OFF or -25% | ON |
| | 1 | Value of PMV1 (Ch2-22) (-25% to 125%) | OFF or -25% | OFF |
| OFF | — | Normal operation | Normal operation | ON |

4. OPERATION

2) Set the operations during standby to STbo.

- See the following table for the operations during standby.

| STBY | STbo setting | Operation during standby | | |
|------|--------------|--|----------------------|---------|
| | | MV output | Output other than MV | Display |
| ON | 0 | Value of PMV1 (Ch2-22) Value of PMC1 (Ch2-37) (-25% to 125%) | OFF or -25% | ON |
| | | Value of PMV1 (Ch2-22) Value of PMC1 (Ch2-37) (-25% to 125%) | | |
| OFF | — | Normal operation | Normal operation | ON |

3) Set the output value (MV) on heating side during control standby to PMV1 (Ch2-22).

Set the output value (MV) on cooling side during control standby to PMC1 (Ch2-37).

This value is output during standby.

On setting standby to OFF, the operation value (MV) restarts in bumplessly.

Example: When PMv1 (Ch2-22) is set to 100.0

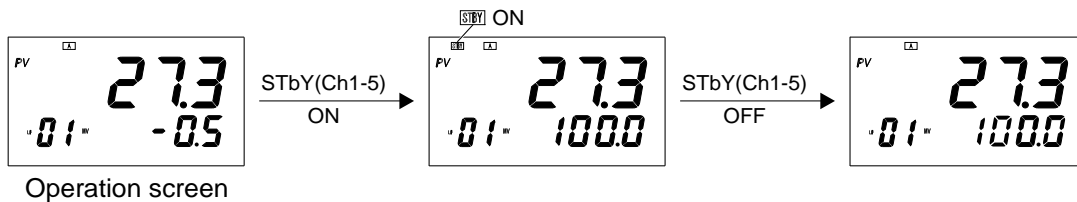

4-6 How to use monitoring function

- Monitoring: Input/output value can be checked with the monitoring function.
- The monitor exists in Ch7 (Mon). See the appended parameter list.

1) Di and Do are displayed as shown below.

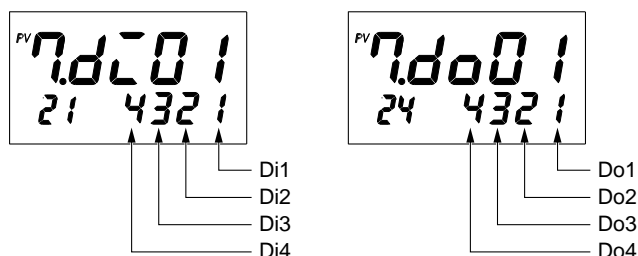

When the value is kept on: ON
When the value is kept off: OFF

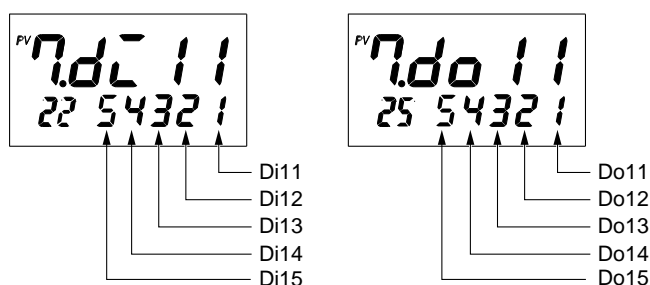

When the value is kept on: ON
When the value is kept off: OFF

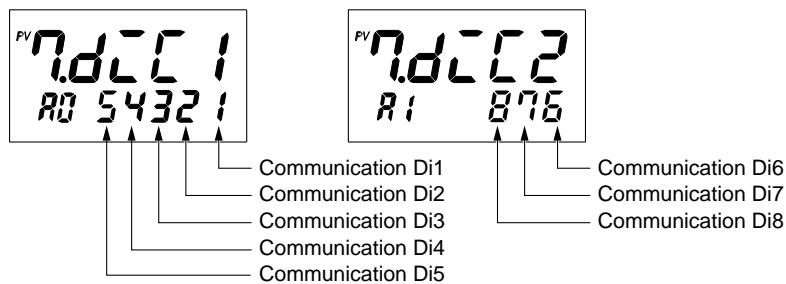

When display stays on: ON
When display stays off: OFF

- 2) Ao1 and Ao2, are in unit of %.
- 3) The unit for TM1 to 8 is changed between seconds and minutes according to the alarm option setting.

[Note]

Contents in monitors cannot be changed.

5 ADVANCED USAGE

5-1 Setting inputs

P1CU PV1 input square-root extractor cut point (Setting range: OFF, 0.0 to 125.0%)

P1TF PV1 input filter time constant (Setting range: 0.0 to 900.0 seconds)

[Description]

1) P1CU(Ch8-11)

Square root extraction

- To convert differential pressure to flow rate, use square root extraction. Where differential pressure is small, the flow rate to the set router cut point is handled as “0” to prevent the flow rate from being changed greatly and becoming unstable by noise.

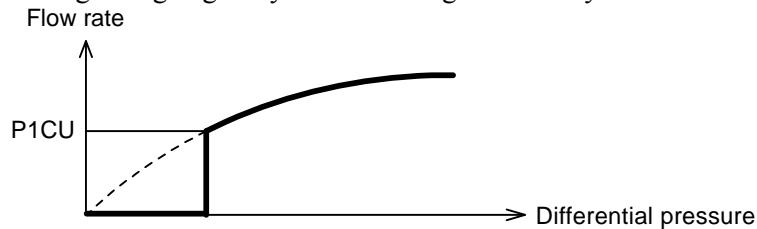

- To use square root extraction for PV2 and Ai1, make the setting for P2CU (Ch8-24) and A1CU (Ch8-49) in the same way.

2) P1TF (Ch8-12)

Input filter

Fluctuation of measurement value by noise, etc. can be suppressed by input filter.

When the value of P1 (Ch2-1) (proportional band on heating side) or PC1 (Ch2-25) (proportional band on cooling side) is small, even a small change of PV makes the MV value fluctuate greatly. Control can be stabilized by filtering in such cases.

This instrument's filter is a first-order lag filter.

If the input filter time constant P1TF is set to 5.0, the PV display gradually changes when input is suddenly changed from 0 to 100% as shown by the following figure, and it takes 5 seconds for the value to change from 0 to 63.2%.

The larger the value of the filter time constant, the stronger the effect of the filter.

| | | |
|--------|----------------|--------|
| Small← | Time constant→ | Large |
| Fast← | Response→ | Slow |
| Weak← | Effect→ | Strong |

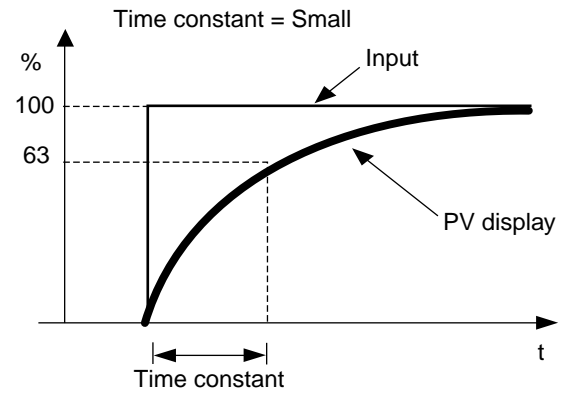
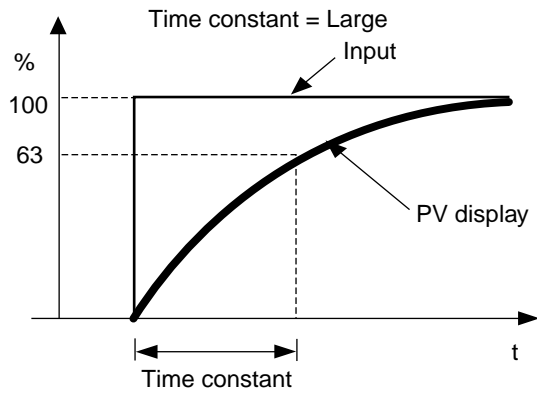

To use the filter for PV2 and Ai1, make the setting for P2TF (Ch8-25) and A1TF (Ch8-50) in the same way.

5-2 Setting output

Mvh1 Upper limit value of operation output (MV) (Setting range: -25.0 to 125.0%FS)

MvL1 Lower limit value of operation output (MV) (Setting range: -25.0 to 125.0%FS)

dMv1 Limit value of MV change rate (Setting range: 0.0 to 150.0%)

[Description]

1) Mvh1 (Ch2-9), MvL1 (Ch2-10)

- Operation output (MV) limit is used to limit the internal MV value.
- If MV is limited, P and I operations in the direction in which MV deviates from the limit are cut off.

[Note]

- Neither upper/lower limit nor scale out does not occur in the following cases.

- 1) During manual operation
- 2) During auto tuning
- 3) During standby
- 4) During EXMV output
- 5) During burnout

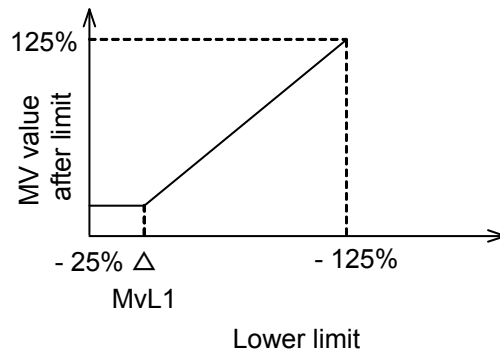
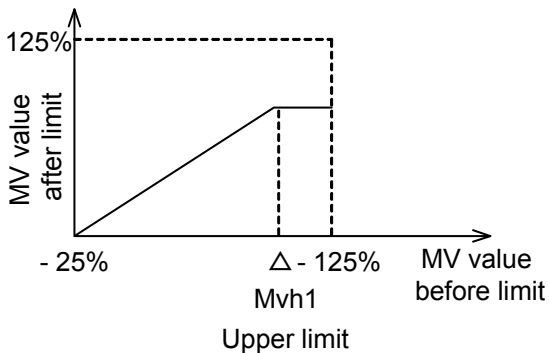

2) dMv1 (Ch2-13)

- Limit value for the change of MV in 1 control cycle (50 msec) can be set.
- Setting 0.0 provides no limit.
- Operation output (MV) set manually during manual operation is also limited.

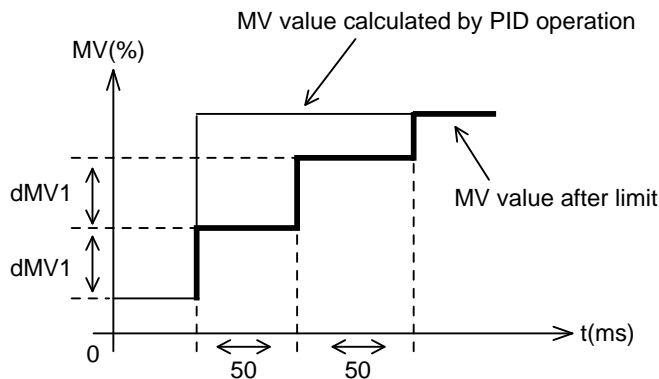

5-3 Setting PID

- P1** Proportional band on heating side (Setting range: 0.0 to 999.9%)
- PC1** Proportional band on cooling side (Setting range: 0.0 to 999.9%)
- i1** Integral time on heating side (Setting range: 0.0 to 3200.0 sec)
- iC1** Integral time on cooling side (Setting range: 0.0 to 3200.0 sec)
- d1** Derivative time on heating side (Setting range: 0.0 to 999.9 sec)
- dC1** Derivative time on cooling side (Setting range: 0.0 to 999.9 sec)
- df1** PID operation cycle setting (Setting range: 5 to 1000 msec)

[Description]

1) P1 (Ch2-1), PC1 (Ch2-25)

[Setting method]

- Setting can be made automatically by auto tuning.
- To set manually, select optimum value in the proportional band with this parameter.

[ON/OFF control]

- Set P1 to 0.0 (PC1 = 0.0) to perform ON/OFF control (2-position control).
- Hysteresis of ON/OFF control can be set with hS1 (Ch2-15).

[Note]

- Generally, if too small a value is set to P (proportional band), the control becomes unstable. If too large a value is set, on the contrary, the reaction becomes slow.
- The instrument is placed under PID control (P≠0, PC1≠0) mode, if auto tuning is performed. If the instrument should be operated with ON/OFF control, do not perform auto tuning.

2) i1 (Ch2-2), iC1 (Ch2-26)

[Setting method]

- Setting can be made automatically by auto tuning.
- To set manually, select optimum integral time with this parameter.

[Positional P operation]

- If i1 is set to 0.0 (iC1 = 0.0), integral action is not carried out. Positional P operation is performed instead.

[Note]

- If P1 (PC1) is set to 0, i1 (iC1) setting is made invalid.

5. ADVANCED USAGE

3) **d1 (Ch2-3), dC1 (Ch2-27)**

[Setting method]

- Setting can be made automatically by auto tuning.
- To set manually, select optimum derivative action time with this parameter.

[Note]

- If d1 is set to 0.0 (dC1 = 0.0), derivative action is not carried out.
- If P1 (PC1) is set to 0, d1 (dC1) setting is made invalid.

4) **dT1 (Ch2-14)**

- Set the cycle of performing control operation (PID operation).

[Note]

- Setting can be made in the unit of 10ms, but operation cycle is changed in the unit of 50ms.

- (Setting example)

When dT1=5 to 9, control operation cycle is 50ms.

When dT1=10 to 14, control operation cycle is 100ms.

5-4 Setting hysteresis

hS1 Hysteresis width at the time of 2-position operation (Setting range: 0 to 50%FS)

[Description]

1) hS1 (Ch2-15)

- To perform ON/OFF control (2-position operation control), set P1 (Ch2-1) to 0.0.
Set PC1 (Ch2-25) to 0.0 for proportional band on cooling side.
i1 (Ch2-2) or d1 (ch2-3) need not be set.
- If the hysteresis width (width of ON/OFF control) is made small, output may be repetitively turned ON/OFF frequently. (In the case of contact output, in particular, the service life of the relay and the operation device may be shortened.)
- The unit of the setting of this parameter is engineering value, but the settable range varies depending on the measurement range of the input.

[Example] Input K Thermocouple: When measurement range is 0 to 400°C
Settable range is 0 to 200°C.
Resistance bulb: When measurement range is 0 to 150°C
Settable range is 0 to 75°C.

Example of parameter setting and operation

1) Reverse action

| Parameter | Set value |
|----------------------------|-----------|
| P1 (Ch2-1) PC1 (Ch2-25) | 0.0 |
| hS1 (Ch2-15) | Arbitrary |
| rEv1 (Ch2-20) | REV |

| Relation between PV and SV | Output |
|----------------------------|--------|
| PV > SV | OFF |
| PV < SV | ON |

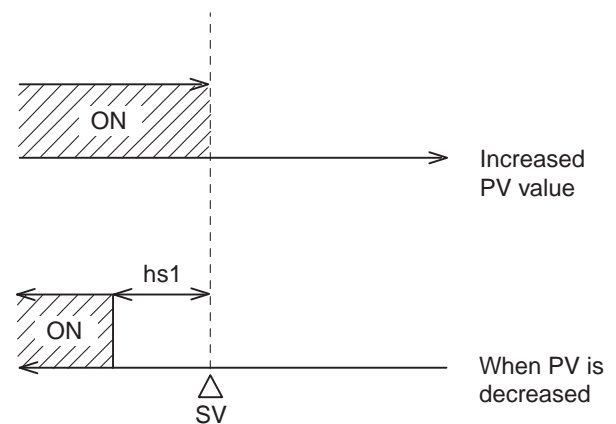

2) Normal (direct) action

| Parameter | Set value |
|----------------------------|-----------|
| P1 (Ch2-1) PC1 (Ch2-25) | 0.0 |
| hS1 (Ch2-15) | Arbitrary |
| rEv1 (Ch2-20) | NRML |

| Relation between PV and SV | Output |
|----------------------------|--------|
| PV > SV | ON |
| PV < SV | OFF |

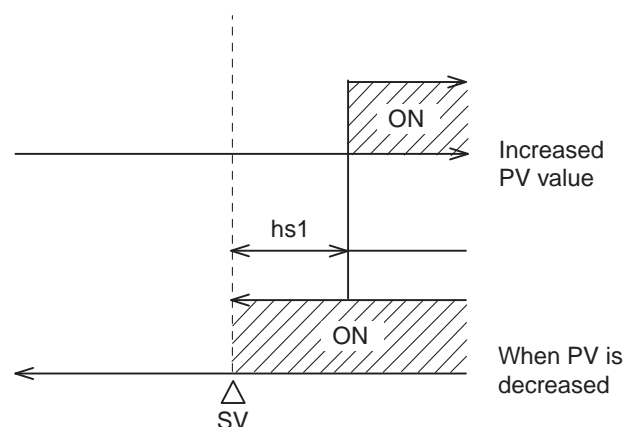

5-5 Setting bAL, Arh, and ArL

bAL 1 Output convergence value (Setting range: -100.0 to 100.0%)

Arh 1 Integration upper cut point (Setting range: 0 to 100%FS)

ArL 1 Integration lower cut point (Setting range: 0 to 100%FS)

[Description]

1) bAL1 (Ch2-18)

- In the case of I=0 (positional P operation)
The value of bAL1 (Ch2-18) is added as offset to the result of PID operation performed with PV and SV, which is regarded as output (MV).

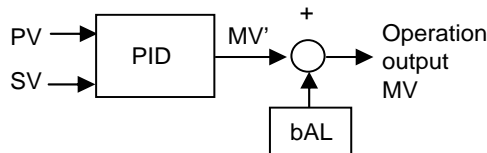

- In the case of PID operation (I≠0)
The value set to bAL becomes the operation output value at the time of power ON.

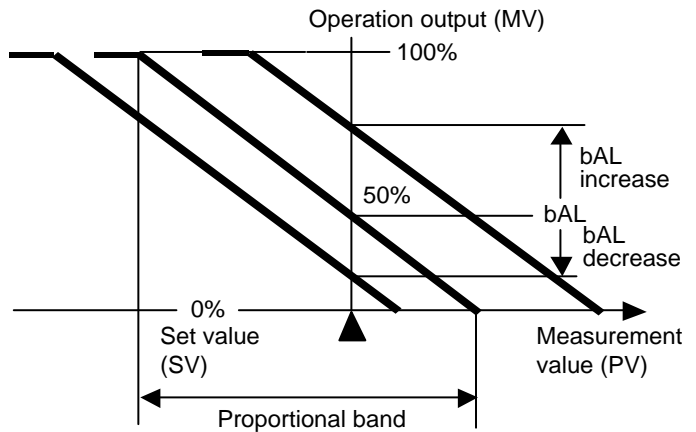

2) Arh1 (Ch2-5), ArL1 (Ch2-6)

- The range where integral action is performed is limited.
- Integration is performed within the range $SV - ArL \leq PV \leq SV + ArH$.
- Integral action is not carried out outside the range.
- If integral action is included in the control operation, overshoot occurs due to initial excessive integration. To prevent this, the range where integral action is performed is limited.

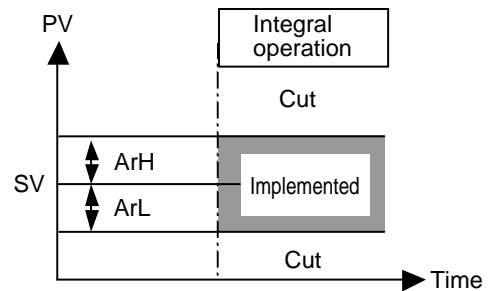

[Note]

- Arh1 (Ch2-5), ArL1 (Ch2-6) and bAL (Ch2-18) are not automatically set by auto tuning.

5-6 Palette function

PLTn Palette selection (Setting range: 0 to 7)

PLTS Palette switching method setting (Setting range: PLTn, SV, PV)

[Description]

This instrument is provided with 7 groups of control palettes (group of control parameters) at Ch3 (PLT), in addition to control parameter at Ch2 (PID). Control can be made while switching these control palettes. Select control palette switching method with PLTS parameter.

1) PLTS (Ch9-31)

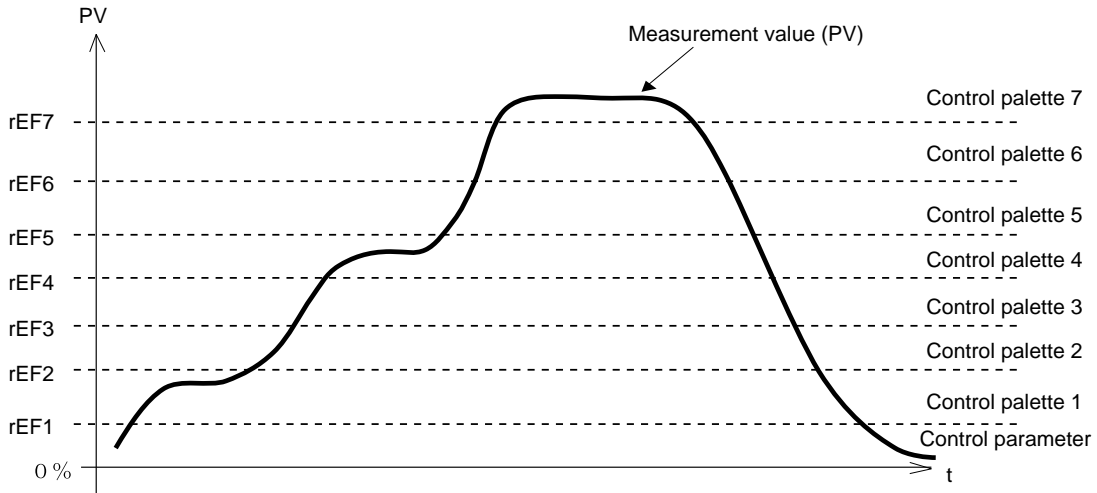
| PLTS setting | Control palette switching method |
|--------------|---|
| PLT n | Operation is performed with the control palette set at PLTn (Ch1-9). The SV of the control palette being selected becomes the current target set value. |
| SV | This is effective when SV selectable type PID control (TPLT=51 or 54) is used. Operation is performed with the control palette of the SV No. selected by Di. See section 3-1 "Setting control template" for details of SV selection type PID control. |
| PV | Operation is performed while control palettes are automatically switched depending on the measurement value (PV), with the value set for rEF1 to rEF7 (Ch4-T1 to T7) regarded as threshold. The following figure shows the relation between the PV reference point and the control palettes.  |

2) PLTn (Ch1-9)

- When PLTS is set to PLTn, set the No. of control palette used for operation.
- When PLTS is set to SV or PV, No. of control palette currently used for operation is displayed. PLTn parameter cannot be set in this case.

[Note]

- 1) Before using the palette function, be sure to set rEF1, and rEF7.
- 2) Set as $rEF1 < rEF2, \dots < rEF7$.
(Unless the above is met, settings will be ignored.)

5-7 Key lock

LoC Key lock setting (Setting range: 0 to 5)

[Description]

1) LoC (Ch1-34)

- Key lock is the function of preventing parameters and set values (SV) from being changed. Note that if the key lock function is made valid, parameters and set values can be displayed.
- Set LoC (Ch1-34) to 0 to reset the key lock function.
- Control operation and alarm operation are performed normally even if the key lock function is made valid.
- The setting of key lock function can be made in the following 6 stages.

| LoC | Key operation | | Via communication | |
|-----|----------------|----------------|-------------------|----------------|
| | All parameters | Set value (SV) | All parameters | Set value (SV) |
| 0 | ○ | ○ | ○ | ○ |
| 1 | X | X | ○ | ○ |
| 2 | X | ○ | ○ | ○ |
| 3 | ○ | ○ | X | X |
| 4 | X | X | X | X |
| 5 | X | ○ | X | X |

○:Setting allowed X:Setting not allowed

5-8 Setting output direction at the input error burnout

brd1 Burnout direction setting (Setting range: HOLD, LO, UP, EXMV)

[Description]

1) brd1(Ch9-35)

- Set the value of operation output (MV) at the time of input error.
Output value can be selected from the following 4 types.

| brd1 | Operation output (MV) at the time of input error |
|-------|---|
| hold | Value of operation output (MV) immediately before burnout |
| LO | -25% |
| UP | 125% |
| EX-MV | EXM1 (Ch2-97) setting |

* See section 5-22 “EX-MV function” for details of EXM1 setting.

Error display

| Display | Cause |
|---------|--|
| UUUU | 1) Burnout of thermocouple sensor 2) Burnout of resistance bulb 3) PV reading exceeds upper limit value +5%FS. 4) RCJ module is not mounted (thermocouple input). |
| LLLL | 1) LLLL display appears for a moment when resistance bulb sensor (line B) breaks. |

- If even one of the inputs related to mathematical expressions (PV1, PV2, Ai1) burns out when Math function (TPLT (Ch8-92) = 50 or 51) is performed, the main unit is brought into burnout state.

* See section 5-14 for details of Math function.
* See section 3-1 for details of control templates.

5-9 User adjustment

PV 1Z Zero adjustment value setting of PV1 input (Setting range: -50% to 50%)

PV 1S Span adjustment value setting of PV1 input (Setting range: -50% to 50%)

[Description]

PV1Z (Ch8-6), PV1S (Ch8-7)

- User calibration function is independent of the adjusted value of the controller main unit. If 0 is set to this parameter, factory-set status can be restored.
- 1) Before starting calibration using this parameter, provide the following devices.
 - Generator
 - 1 to 5V (For voltage input)
 - 0 to 100mV (For thermocouple)
 - 0 to 100mA (For current input)
 - Dial resistor
 - 100.0 to 400.0Ω (For resistance bulb input)
 - 2) Apply input equivalent to 0%.
 - If the error is out of permissive range, set PV1Z (Ch8-6).
(See the following example for setting method.)
 - 3) Apply input equivalent to 100%.
 - If the error is out of permissive range, set PV1S (Ch8-7).
(See the following example for setting method.)

[Example of adjustment for input range of 0°C to 400°C]

| Before adjustment | Adjusted value | After adjustment |
|-------------------------------|----------------|-------------------------------|
| Reading at 0°C input: -1°C | PV1Z: 1 | Reading at 0°C input: 0°C |
| Reading at 400°C input: 402°C | PV1S: -2 | Reading at 400°C input: 400°C |

If 0 is set both to PV1Z and PV1S parameters, factory-set calibration status is restored.

[Note]

- Check the value of each input with monitoring parameters in Ch7 (MON).
To adjust thermocouple input, set parameter rCJ1 to OFF before performing operation in [item 2)] above, and when the operation in [item 3)] above is completed, set it to ON again.
See section 5-21 “Setting parameter mask” for procedure of displaying parameter rCJ.

| |
|------------------------|
| rCJ1 display mask=20-6 |
| rCJ2 display mask=21-6 |
- To use it as input offset, set the same value to PV1Z and PV1S. The shift is made by the set value.
- To adjust PV2, set PV2Z (Ch8-19) and PV2S (Ch8-20).
To adjust Ai1, set Ai1Z (Ch8-45) and Ai1S (Ch8-46).

5-10 Digital input (Di) function

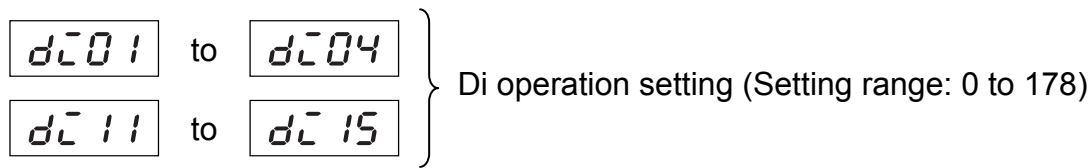

[Description]

di01 (Ch9-39) to di04 (Ch9-42)

di11 (Ch9-43) to di15 (Ch9-47) [only for 9 digital input point model.]

Select each Di function with Di setting parameter, and set Di to ON to operate.

| Di1 to Di15 setting | Function | Operation Conditions | | | |
|---------------------|---|------------------------|------------------------|----------------|------------|
| | | Status detection | | Edge detection | |
| | | ON | OFF | ON | OFF |
| 0 | None | - | - | - | - |
| 1 | STBY (standby) | Standby | RUN | - | - |
| 30 | AT (Auto tuning) | - | - | AT start | AT stop |
| 40 | Alarm latch reset (Alarm 1) to (Alarm 8) Release all | - | - | Release all | Latch hold |
| 50 to 57 | Timer operation (Alarm 1) to (Alarm 8) | ON | OFF | - | - |
| 60 | R-ACK (Remote acknowledge) | Remote | Local | - | - |
| 70 | SMV (Manual command) | Manual mode | Auto mode | - | - |
| 80 | PV-TRK command (PV tracking) | ON | OFF | - | - |
| 103 | EX-MV (External output value) | EX-MV | MV | - | - |
| 140 | Switching of the active expression for Math function | Hi selector expression | Lo selector expression | - | - |
| 160 | Totalizer start/stop, reset | HOLD | RUN | - | - |
| 161 | | LATCH | RUN | - | - |
| 162 | | Reset | - | - | - |
| 170 | Ramp/soak OFF | - | - | OFF | - |
| 171 | Ramp/soak RUN/HOLD | - | - | RUN | HOLD |
| 172 | Ramp/soak RUN | - | - | RUN | - |
| 173 | Ramp/soak HOLD | - | - | HOLD | - |
| 174 | Ramp/soak activation pattern No. +1 | +1 | - | - | - |
| 175 | Ramp/soak activation pattern No. +2 | +2 | - | - | - |
| 176 | Ramp/soak activation pattern No. +4 | +4 | - | - | - |
| 177 | Ramp/soak activation pattern No. +8 | +8 | - | - | - |
| 178 | Ramp/soak activation pattern No. +16 | +16 | - | - | - |

1) Switching between control RUN and Standby (Di setting=1)

- Switching can be done between control RUN and Standby with Di.
ON: Standby
OFF: RUN

5. ADVANCED USAGE

2) Auto tuning start (AT) (Di setting=30)

- Switching can be done between Start and Stop of auto tuning.

| Auto tuning type | Di | |
|--------------------|--------------------------|-----------------------------|
| | $\overline{\uparrow}$ ON | $\overline{\downarrow}$ OFF |
| Normal type (NRML) | AT start | AT stop |
| Low PV type (LPV) | | |

* Type of auto tuning (NRML, LPV) is selected with ATP1 (ChE-1) beforehand.

3) Alarm latch reset (Di setting=40)

- The latched alarm can be released with this function.

| Di setting | Di | |
|------------|-------------------------------|------------|
| | ON | OFF |
| 40 | Latch release (all alarms) | Latch hold |

4) Timer operation (Di setting=50 to 57)

- When the code is set to 36 to 38 with alarm type setting, timer ON/OFF can be selected. See section 3-8 "Alarm function" for details of timer operation.

ON: Timer operation ON, OFF: Timer operation OFF

| Di Setting | Timer operation |
|------------|-----------------|
| 50 | ALM1 |
| 51 | ALM2 |
| 52 | ALM3 |
| 53 | ALM4 |
| 54 | ALM5 |
| 55 | ALM6 |
| 56 | ALM7 |
| 57 | ALM8 |

5) R-ACK (Remote acknowledge) (Di setting=60)

- Changeover between Auto and Remote can be done with Di.
- To use this function, set TPLT (Ch8-92) to 50 or 53, rAC1 (Ch9-11) to EnA, and rEM1 (Ch1-1) to rEM.

[Example: Di1 is allocated to this function]

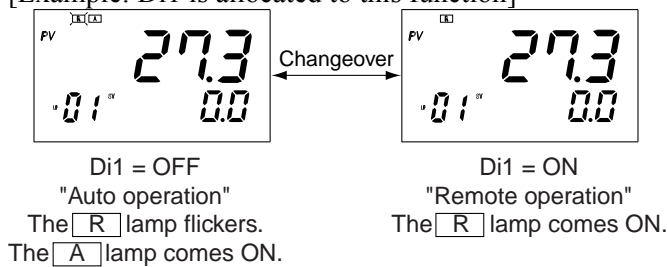

- * After changing TPLT (Ch8-92) setting, be sure to reset the instrument or turn the power on again.
- * See section 5-16 for details of R-ACK (remote acknowledge).

6) SMV (Manual command) (Di setting=70)

- Changeover between Auto and Manual operation can be done with Di.
- To use this function, set TPLT (Ch8-92) to 50 or 53.

[Example: Di2 is allocated to this function]

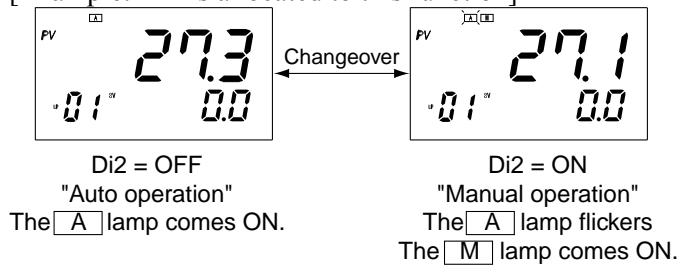

* After changing TPLT (Ch8-92) setting, be sure to reset the instrument or turn the power on again.

7) PV tracking (Di setting=80)

- SV value can be tracked to PV value.
- Select one Di from Di 1 to 4 or Di 11 to 15, and set it to "80."
- Set the selected Di to ON or OFF to perform switching.

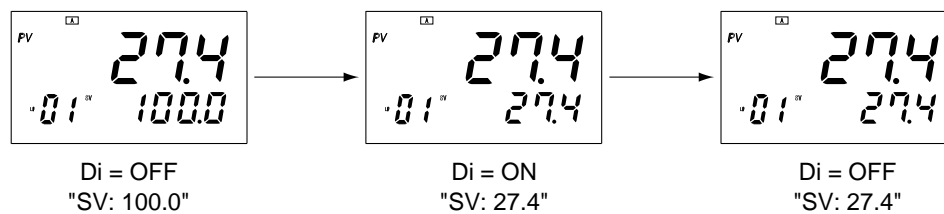

8) EX-MV (Di setting=103)

- Switching between MV (operation output) and EX-MV (external output) can be done with Di.
- Set Di to OFF to select MV, and set it to ON to select EX-MV.

When EXM1 (Ch2-97) is set to 60.0

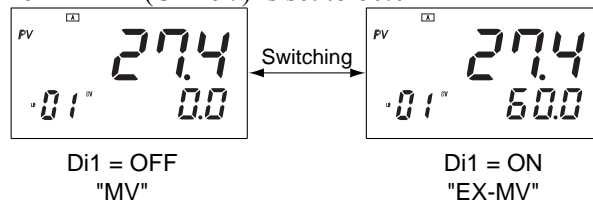

* See section 5-22 "EX-MV function" for details.

9) Switching the active expression for Math function. (Di setting: 140)

- Di input is used as a selector switch between Lo selector/Hi selector expressions in the case of CALC (Ch8-88) is set as follows.

| CALC setting | Name of operation | Di input | |
|--------------|---|-------------|-------------|
| | | OFF | ON |
| 12 | H/L selector, 2 points | Lo selector | Hi selector |
| 13 | H/L selector, 3 points | Lo selector | Hi selector |
| 32 | H/L selector, 2 points (with coefficient) | Lo selector | Hi selector |
| 33 | H/L selector, 3 points (with coefficient) | Lo selector | Hi selector |

5. ADVANCED USAGE

10) Totalizer RUN/HOLD and LATCH (Di setting=160, 161)

| Di setting | Di input | |
|------------|----------|-------|
| | OFF | ON |
| 160 | RUN | HOLD |
| 161 | RUN | LATCH |

* See “RUN/HOLD/LATCH” in section 5-25 “Totalizer function” for details.

11) Totalizer RESET (Di setting=162)

| Di setting | Di input | |
|------------|----------|-------|
| | OFF | ON |
| 162 | – | RESET |

* See “Totalize RESET” in section 5-25 “Totalizer function” for details.

12) Ramp/soak

Switches the Ramp/soak operation and specify the activation pattern.

| DI setting value | Di | |
|------------------|----------------|--------------------------------------|
| | OFF | ON |
| 170 | – | Ramp/soak OFF |
| 171 | Ramp/soak HOLD | Ramp/soak RUN |
| 172 | – | Ramp/soak RUN |
| 173 | – | Ramp/soak HOLD |
| 174 | – | Ramp/soak activation pattern No. +1 |
| 175 | – | Ramp/soak activation pattern No. +2 |
| 176 | – | Ramp/soak activation pattern No. +4 |
| 177 | – | Ramp/soak activation pattern No. +8 |
| 178 | – | Ramp/soak activation pattern No. +16 |

[Note]

* Please refer to "0

5-11 Digital output (Do) function

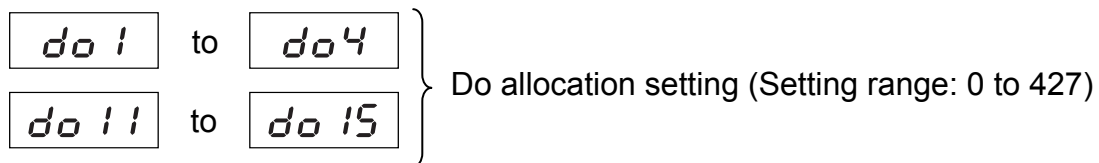

[Description]

1) do1(Ch9-53) to do4(Ch9-56)

do11 (Ch9-57) to do15 (Ch9-61) [only for 9 digital output point model]

- Select signals to be output to digital output (Do).
- Do keeps output even if the input value becomes error (ex. UUUU, LLLL).
- · If OTYP (Ch8-93) is set to 51,52,53,54, or 55, and MV is allocated, priority is given to MV.

See the following table for the setting.

| Do Setting | Output signal |
|------------|-------------------------------------|
| 0 | No setting |
| 1 | ALM1 |
| 2 | ALM2 |
| 3 | ALM3 |
| 4 | ALM4 |
| 5 | ALM5 |
| 6 | ALM6 |
| 7 | ALM7 |
| 8 | ALM8 |
| 17 | OR of ALMs |
| 29 | System fault |
| 41 | Totalizer ALM1 |
| 42 | Totalizer ALM2 |
| 80 | Manual MV (status) |
| 81 | EX-MV command (status) |
| 82 | Remote SV (status) |
| 83 | Local SV (status) |
| 84 | PV tracking (status) |
| 85 | Normal (Direct) action (status) |
| 86 | Auto tuning (AT) (status) |
| 87 | Remote request (status) |
| 88 | Remote acknowledge (R-ACK) (status) |
| 89 | Not-Auto (status) |
| 90 | Mode OR output 1 |
| 91 | Mode OR output 2 |
| 160 | Ramp/soak OFF |
| 161 | Ramp/soak RUN |
| 162 | Ramp/soak HOLD |
| 163 | Ramp/soak GS |
| 164 | Ramp/soak END |
| ... | |
| 170 | Time signal (1st segment) |
| 171 | Time signal (2nd segment) |
| ... | Time signal (3rd to 126th segment) |

*1

*2

5. ADVANCED USAGE

| Do Setting | Output signal |
|------------|---|
| 296 | Time signal (127th segment) |
| 297 | Time signal (128th segment) |
| ... | |
| 300 | Relative time signal (1st segment) |
| 301 | Relative time signal (2nd segment) |
| ... | Relative time signal (3rd to 126th segment) |
| 426 | Relative time signal (127th segment) |
| 427 | Relative time signal (128th segment) |

*1) Contents of OR operation: Manual + Auto

*2) Contents of OR operation: Manual + EX-MV

5-12 Setting LED allocation

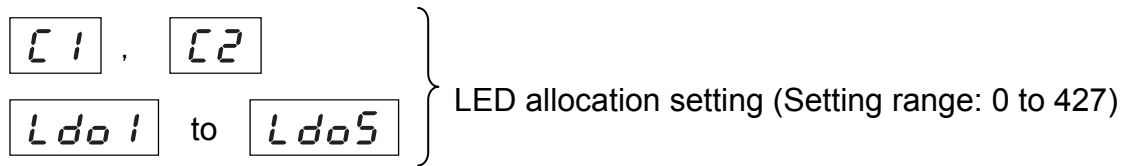

[Description]

- 1) C1 (Ch9-67), C2 (Ch9-68)
Ldo1 (Ch9-69) to Ldo5 (Ch9 to 73)

- Make the setting to change signals to be output to the lamp on the front face.
- See the following table for the setting.

| C1, C2 Ldo1 to Ldo5 | Type | |
|------------------------|-------------------------------------|----|
| 0 | No setting | |
| 1 | ALM1 | |
| 2 | ALM2 | |
| 3 | ALM3 | |
| 4 | ALM4 | |
| 5 | ALM5 | |
| 6 | ALM6 | |
| 7 | ALM7 | |
| 8 | ALM8 | |
| 17 | OR of ALMs | |
| 21 | Output (MV) 1 | *3 |
| 22 | Output (MV) 2 | *3 |
| 29 | System fault | |
| 41 | Totalizer ALM1 | |
| 42 | Totalizer ALM2 | |
| 80 | Manual MV (status) | |
| 81 | EX-MV command (status) | |
| 82 | Remote SV (status) | |
| 83 | Local SV (status) | |
| 84 | PV tracking (status) | |
| 85 | Normal (Direct) action (status) | |
| 86 | Auto tuning (AT) (status) | |
| 87 | Remote request (status) | |
| 88 | Remote acknowledge (R-ACK) (Status) | |
| 89 | Not-Auto (status) | |
| 90 | Mode OR output 1 | *1 |
| 91 | Mode OR output 2 | *2 |
| 160 | Ramp/soak OFF | |
| 161 | Ramp/soak RUN | |
| 162 | Ramp/soak HOLD | |
| 163 | Ramp/soak GS | |
| 164 | Ramp/soak END | |
| ... | | |
| 170 | Time signal (1st segment) | |
| 171 | Time signal (2nd segment) | |
| ... | Time signal (3rd to 126th segment) | |

5. ADVANCED USAGE

| C1, C2 Ldo1 to Ldo5 | Type |
|------------------------|---|
| 296 | Time signal (127th segment) |
| 297 | Time signal (128th segment) |
| ... | |
| 300 | Relative time signal (1st segment) |
| 301 | Relative time signal (2nd segment) |
| ... | Relative time signal (3rd to 126th segment) |
| 426 | Relative time signal (127th segment) |
| 427 | Relative time signal (128th segment) |

*1) Contents of OR operation: Manual + Auto

*2) Contents of OR operation: Manual + EX-MV

*3) The lamp does not come ON for current (4 to 20mA) output type.

5-13 Function key

F1 to **F3** Function key allocation setting (Setting range: 0 to 72)

[Description]

F1(Ch9-32) to F3(Ch9-34)

- Functions listed in the following table can be allocated to the F1, F2, and the F3 keys.
The F1, F2, and the F3 keys are collectively called F key.

| F key setting (Function key code) | Key operation |
|--------------------------------------|---|
| 0 | No function |
| 1 | dSV display Changeover between Remote and Auto (Press for 2 seconds.) Note 1 |
| 2 | Standby/RUN changeover |
| 3 | Alarm latch reset |
| 10 | AT (Auto tuning) START/STOP |
| 20 | Timer operation start/stop (ALM 1) |
| 21 | Timer operation start/stop (ALM 2) |
| 22 | Timer operation start/stop (ALM 3) |
| 23 | Timer operation start/stop (ALM 4) |
| 24 | Timer operation start/stop (ALM 5) |
| 25 | Timer operation start/stop (ALM 6) |
| 26 | Timer operation start/stop (ALM 7) |
| 27 | Timer operation start/stop (ALM 8) |
| 30 | Totalizer RUN/HOLD |
| 31 | Totalizer RUN/LATCH |
| 32 | Totalizer RESET |
| 41 | Transfer of SV1 to local SV |
| 42 | Transfer of SV2 to local SV |
| 43 | Transfer of SV3 to local SV |
| 44 | Transfer of SV4 to local SV |
| 45 | Transfer of SV5 to local SV |
| 46 | Transfer of SV6 to local SV |
| 47 | Transfer of SV7 to local SV |
| 50 | Selection of palette 0 |
| 51 | Selection of palette 1 |
| 52 | Selection of palette 2 |
| 53 | Selection of palette 3 |
| 54 | Selection of palette 4 |
| 55 | Selection of palette 5 |
| 56 | Selection of palette 6 |
| 57 | Selection of palette 7 |
| 60 | Parameter jump 1 |
| 61 | Parameter jump 2 |
| 62 | Parameter jump 3 |
| 70 | Change over the "RUN/OFF" of Ramp/soak |
| 71 | Change over the "RUN/HOLD" of Ramp/soak |
| 72 | Send pattern No.+1 |

5. ADVANCED USAGE

Note 1: Do not use this setting when TPLT (Ch8-92) is set to 51 or 54.

1) dSV display Remote/Auto changeover (Function key code=1)

- Press the F key once. : By pressing the F key once on the operation display, the dSV display and the PV/SV operation display (or PV/MV operation display) can be displayed alternately.

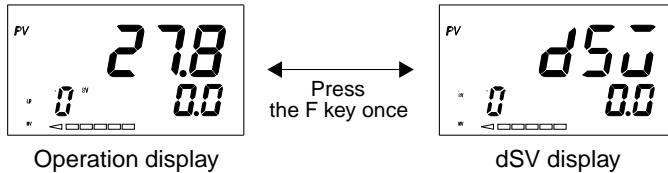

Note: Switching between the operation display and the dSV display can be done both in Auto and Remote operation modes.

- Press the F key for 2 seconds. : By pressing the F key for 2 seconds on the operation display, changeover between Remote and Auto operations is executed.

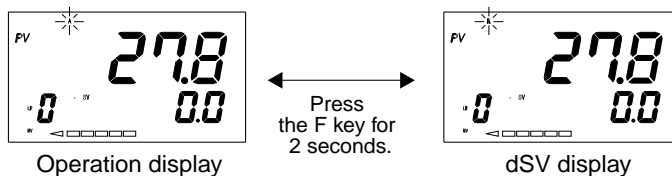

- How to use the dSV display

Use the dSV display to balance the Remote SV and the Local SV when switching operation mode from Auto to Remote.

(When operation is switched from Remote to Auto, the set value (SV) is automatically balanced, which is SV tracking function.)

$$\text{dSV} = \text{Local SV} - \text{Remote SV}$$

[Example of use]

Operation mode = Auto

Local SV = 50.0°C

Remote SV = 200.0°C

dSV = -150.0°C (=50.0°C - 200.0°C) is displayed.

Procedure 1: Press the F key once to show the dSV display.

Procedure 2: Using the \blacktriangleright , \blacktriangle , and the \blacktriangledown key, change the value of dsv from -150.0 to 0.0.

(When dSV is set 0.0, the Local SV becomes equal to the Remote SV.)

Procedure 3: Press the F key for 2 seconds to switch operation from Auto to Remote.

(The controller is operated with the Remote SV (externally set signal) regarded as target set value.)

[Note]

- If the operation cannot be switched from Auto to Remote by following the procedures shown above, check rAC (Ch9-11) parameter. See section 5-16 "Remote acknowledge (R-ACK) function" for details of rAC parameter.
- If the set value (SV) cannot be automatically balanced when operation is switched from Remote to Auto, check Trk1 (Ch9-23) parameter. See section 5-19 "SV tracking function" for details of Trk1 parameter.

- 2) Standby/RUN changeover (Function key code=2)
- Control can be switched between RUN and Standby with the F key.
 - Press the F key for 1 second to switch.

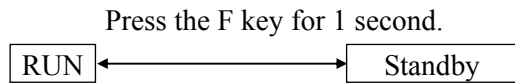

- * See section 4-5 for details of standby function.
- 3) Alarm latch reset (Function key code=3)
- The latched alarm can be released with this function.
- 4) Auto tuning (AT) (Function key code=10)
- Auto tuning start and stop can be switched.

| | | |
|---------------------|----------|---------|
| Type of auto tuning | F key ← | → F key |
| Standard Low PV | AT start | AT stop |

- * See section 3-7 “AT (Auto tuning)” for details.
- 5) Timer operation (Function key code=20 to 27)
- When alarm type code is set to 36 to 38 with alarm function, timer ON/OFF can be selected. See section 3-8 “Alarm function” for details of timer operation.
- 6) Totalizer START/HOLD/LATCH and RESET operation (Function key code = 30 to 32)
- Use this function to perform totalizer operation control.
- The following functions can be allocated to function keys.

| Function key | Function | Note |
|--------------|-------------|--|
| 30 | RUN / HOLD | Every time the function key is pressed |
| 31 | RUN / LATCH | Every time the function key is pressed |
| 32 | RESET | Press the function key for 1 second |

- 7) Local SV switching (Function key code = 41 to 47)
- The settings for palettes 1 to 7, SV1 to SV7, can be used as Local SV.
 - Press the F key for 1 second to make.
 - Switching can be made only when PV/SV is displayed on the operation screen.
 - * This function is available even when operation is performed in SV selectable controller.
 - * This function is available even when Remote operation is performed.
 - (1) Operation is performed with switched SV at the time of R → A, if SV tracking function is OFF.
 - (2) Operation is performed with Remote SV at the time of R → A, if SV tracking function is ON.
- 8) Palette number selection (Function key code = 50 to 57)
- Use this function to switch palette numbers (PLTn parameter).
 - Palette number 0 means Local PID control parameters. (Ch2 Pid)
 - Palette numbers 1 to 7 mean control palettes. (Ch3 PLT)
 - Press the F key for 1 second to make.
 - Switching can be made only when PV/SV is displayed on the operation screen.

5. ADVANCED USAGE

9) Parameter jump (Function key code = 60 to 62)

- Use the function to jump to set parameters specified beforehand.
- The destination of the jump is the parameter set in “JP parameter setting.”
- Press the key once to jump to the specified parameter.
- Jump can also be made on the operation, parameter display, and monitor screens.

| Function key | Function | Parameter for setting destination of jump |
|--------------|------------------|---|
| 60 | Parameter jump 1 | JP1 (Ch1-35) |
| 61 | Parameter jump 2 | JP2 (Ch1-36) |
| 62 | Parameter jump 3 | JP3 (Ch1-37) |

See “JP parameter setting” on the next page for details of jump destination parameter setting.

- * “PAS1” is displayed if a maked parameter or channel is specified and the F key is pressed.
- * Even if the F key is pressed while parameter setting is performed, jump to a parameter does not occur.

10) Ramp/soak

- When Ramp/soak operation setting is set, following can be used.
- Following functions can be allocated to the function key.

| Function key | Function | Note |
|--------------|---|--|
| 70 | RUN/OFF | Everytime press the function key, Ramp/soak RUN/OFF will be changed over. |
| 71 | RUN/HOLD | Everytime press the function key, Ramp/soak RUN/HOLD will be changed over. |
| 72 | Current Ramp/soak activation pattern +1 | Sends the Ramp/soak pattern №+ 1 |

Note: Ramp/soak activtaion pattern chaged over by function key “72” will be changed over by pattern selection Max. and Min. setting (PTnM, PMin)
Please refer to “5-29 Ramp/Soak” concerning pattern selection Max. and Min. setting.

JP 1 to **JP 3** JP parameter setting (Setting range: 1-01 to z-z9)

[Description]

JP1 (Ch1-35), JP2 (Ch1-36), JP3 (Ch1-37)

- Enabled when parameter jump function is allocated to function keys
The parameter to which the jump is to be made can be set.
See the following table for the function key setting and parameters to which, jump is to be made.

| JP parameter | Function key setting |
|--------------|----------------------|
| JP1 (Ch1-35) | 60 |
| JP2 (Ch1-36) | 61 |
| JP3 (Ch1-37) | 62 |

1) JP parameter setting method

Parameters can be allocated as JP parameters as follows.

Use channels and parameter numbers to make parameter setting.

[Example] When allocating alarm 1 setting AL1 (ch1-10) to F1 key to make a jump

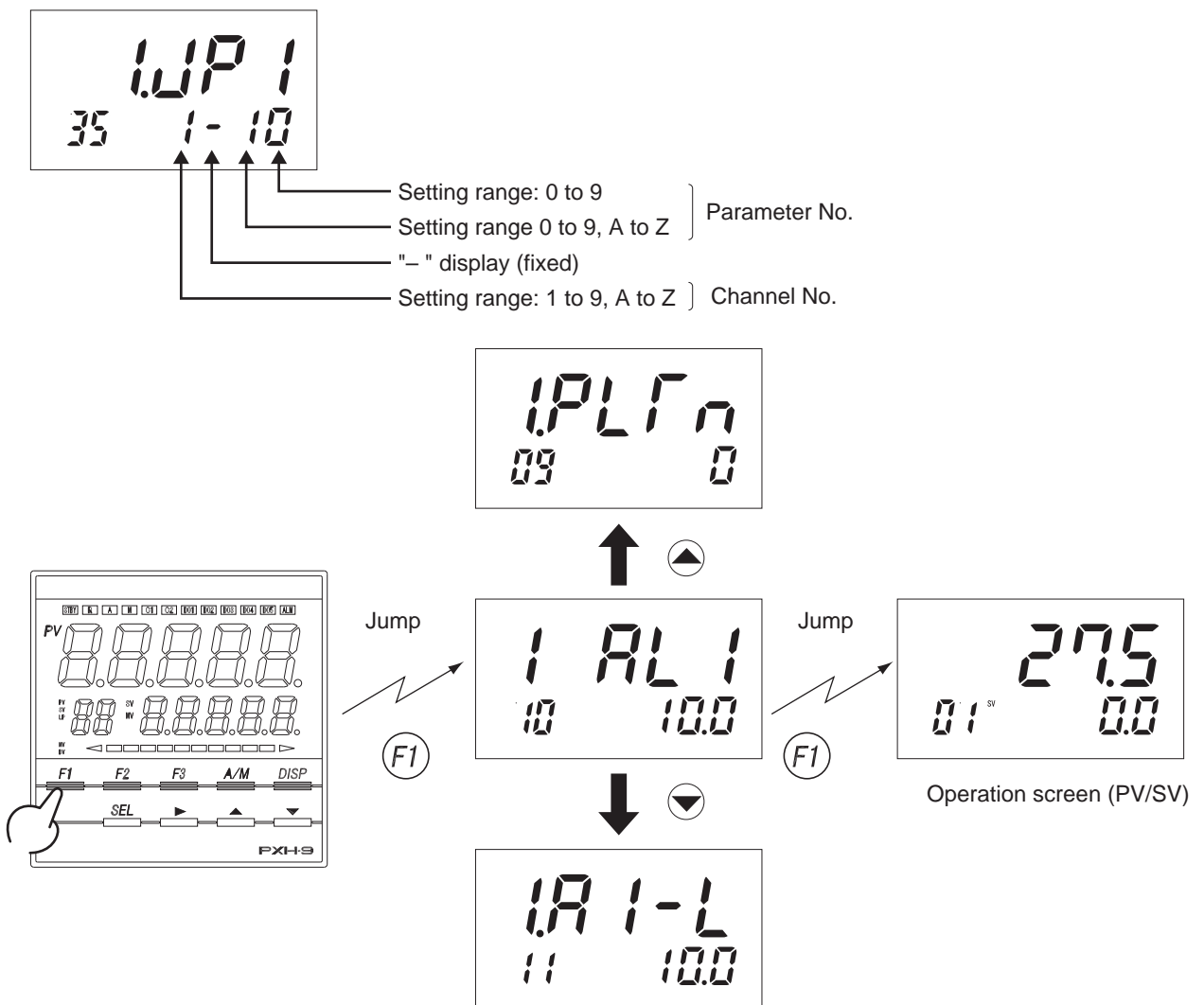

* After a jump is made, transfer between parameters and setting can be made as usual.

5-14 Math function

- CALC Math function type setting (Setting range: 0 to 40)
 - UCF 1 Scale of Math function on the full side
 - UCb 1 Scale of Math function on the base side
 - UCd 1 Decimal point position of Math function (Setting range: 0 to 3)
 - t0 1 to t 16 The constant for expression (Setting range: -9999 to 99999)
- } (Setting range: -19999 to 99999)

[Description]

What is Math function?

By substituting arbitrary values into input value (PV1, PV2, Ai1) and constant (k01 (ChD-1) to k16 (ChD-16)), the result of operation M1 can be used as PV, which is called Math function. (See the following figure.)

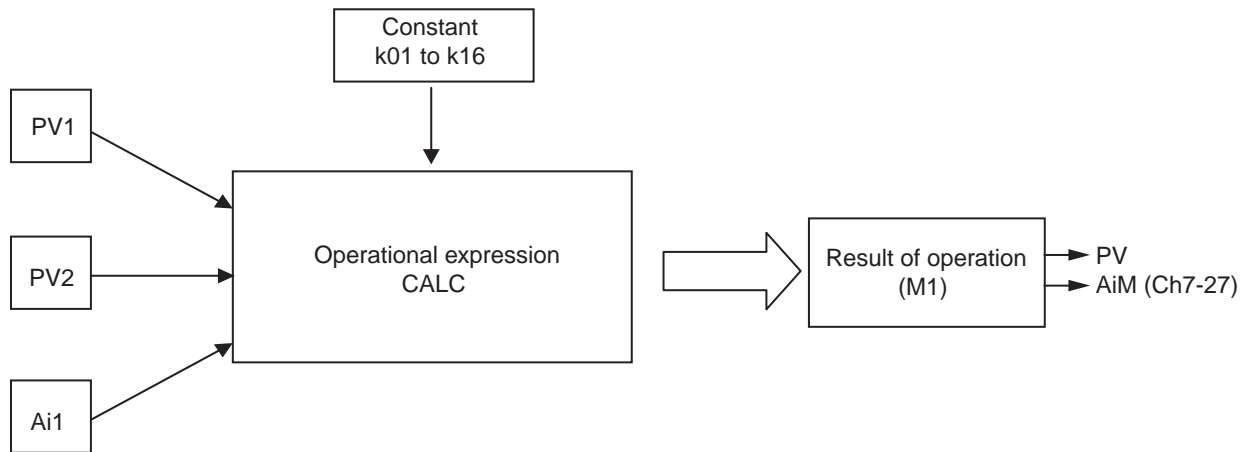

Set the control template TPLT (Ch8-92) to 50 or 51 to use Math function.

[IMPORTANT]

In the case of using the result of operation (M1) as PV, the scale of PID operation (i.e. Full Scale) is defined with UCF1, UCb1, and UCd1.

1) CALC (Ch8-88)

- Select the type of arithmetic expressions.
- There are 24 types of arithmetic expressions. (See the following table.)

| CALC setting | Name of operation | Arithmetic expression |
|--------------|--|--|
| 0 | No math operation | M1 = PV1 input |
| 1 | Mathematical expression 1 (Flow rate compensation with temperature and pressure) | $M1 = k01 \times \sqrt[1]{PV1} \times \sqrt[2]{\frac{Ai1 + k02}{k03} \times \frac{k04}{PV2 + k05}}$ PV1: Flow rate (differential pressure), PV2: Temperature, Ai1: Pressure |
| 2 | Mathematical expression 2 (Flow rate compensation with temperature and pressure) | $M1 = k01 \times PV1 \times \sqrt[1]{\frac{Ai1 + k02}{k03}} \times \frac{k04}{PV2 + k05}$ PV1: Flow rate (differential pressure), PV2: Temperature, Ai1: Pressure |
| 3 | Mathematical expression 3 (Flow rate compensation with temperature and pressure) | $M1 = k01 \times PV1 \times \frac{Ai1 + k02}{k03} \times \frac{k04}{PV2 + k05}$ PV1: Flow rate (differential pressure), PV2: Temperature, Ai1: Pressure |
| 4 | Mathematical expression 4 | $M1 = \frac{(k01 \times (k02 \times PV1 + k03 \times PV2 + k04 \times Ai1) + k05)}{(k06 \times (k07 \times PV1 + k08 \times PV2 + k09 \times Ai1) + k10)}$ |
| 5 | Mathematical expression 5 | $M1 = \frac{(k01 \times ((k02 \times PV1 + k03) \times (k04 \times PV2 + k05) \times (k06 \times Ai1 + k07))) + k08}{(k09 \times ((k10 \times PV1 + k11) \times (k12 \times PV2 + k13) \times (k14 \times Ai1 + k15)) + k16)}$ |
| 6 | Mathematical expression 6 | $M1 = k01 \times PV1 \times (k02 \times PV2 + k03 \times Ai1) + k04 \times Ai1 + k05$ |
| 7 | H selector (2 points) | M1 = Max (PV1, PV2) PV1 or PV2, whichever is larger, is selected. |
| 8 | L selector (2 points) | M1 = Min (PV1, PV2) PV1 or PV2, whichever is smaller, is selected. |
| 9 | H selector (3 points) | M1 = Max (PV1, PV2, Ai1) PV1, PV2, or Ai1, whichever is largest, is selected. |
| 10 | L selector (3 points) | M1 = Min (PV1, PV2, Ai1) PV1, PV2, or Ai1, whichever is smallest, is selected. |
| 11 | Input switching (2 points) | M1 = PV1 when $PV1 \leq k01$, M1 = PV2 when $PV1 > k01$ |
| 12 | H/L selector (2 points) (with Di switching function) | Expression 7 or 8 is used by Di switching. (Specify "140" for Di function for switching.) |
| 13 | H/L selector (3 points) (with Di switching function) | Expression 9 or 10 is used by Di switching. (Specify "140" for Di function for switching.) |
| 20 | Flow rate compensation with temperature and pressure [% value operation] | $M1 = \sqrt{PV1} \times \frac{(Ai1 + k01) + k02}{(PV2 \times k03) + k04}$ PV1: Differential pressure (flow rate) % value, k01: Pressure compensation constant 1, k04: Temperature compensation constant 2 PV2: Fluid temperature % value, k03: Temperature compensation constant 1 Ai1: Differential pressure % value, k02: Pressure compensation constant 2, k05: Square-root extractor cut point *Input data: % value (0 (0%) to 100000 (100.000%)) |
| 21 | Flow rate compensation with temperature and pressure [% value operation] (without square-root extraction) | $M1 = PV1 \times \frac{(Ai1 \times k01) + k02}{(PV2 \times k03) + k04}$ All the inputs and constants are of the same specifications as mathematical expression 20. |
| 27 | H selector (2 points) (with coefficient) | $M1 = \max((PV1 \times k01 + k02), (PV2 \times k03 + k04))$ |
| 28 | L selector (2 points) (with coefficient) | $M1 = \min((PV1 \times k01 + k02), (PV2 \times k03 + k04))$ |
| 29 | H selector (3 points) (with coefficient) | $M1 = \max((PV1 \times k01 + k02), (PV2 \times k03 + k04), (Ai \times k05 + k06))$ |
| 30 | L selector (3 points) (with coefficient) | $M1 = \min((PV1 \times k01 + k02), (PV2 \times k03 + k04), (Ai \times k05 + k06))$ |
| 31 | Input switching (2 points) (with coefficient) | M1 = (PV1 X k02 + k03) when $k01 > (PV1 \times k02 + k03)$ M1 = (PV2 X k04 + k05) when $k01 \leq (PV1 \times k02 + k03)$ |
| 32 | H/L selector (2 points) (with Di switching function) | Expression 27 or 28 is used by Di switching. (Specify "140" for Di function for switching.) |
| 33 | H/L selector (3 points) (with Di switching function) | Expression 29 or 30 is used by Di switching. (Specify "140" for Di function for switching.) |
| 34 | Input switching (2 points) (with coefficient and interpolation function) | When $PV1 \leq k05$: $M1 = (PV1 \times k01) + k02$ When $PV2 \leq k06$: $M1 = (PV2 \times k03) + k04$ When $PV1 > k05$ and $PV2 < k06$: Interpolation shown below, is executed. $M1 = \left(1 - \frac{(PV1 \times k01 + k02) - k05}{k06 - k05}\right) \times (PV1 \times k01 + k02) - k05 - \left(\frac{(PV1 \times k01 + k02) - k05}{k06 - k05}\right) \times (PV2 \times k03 + k04)$ * note) k05 : Input switching upper value k06 : Input switching lower value |
| 40 | Calorie calculation | $M1 = ((PV1 \times k01 + k02) - (PV2 \times k03 + k04)) \times (Ai1 \times k05 + k06)$ |

*1: Square-root extraction cut point can be set with k06.

*2: Square-root extraction cut point can be set with k07.

5. ADVANCED USAGE

2) UCF1 (Ch8-89)

UCb1 (Ch8-90)

- The scale of the full side (upper limit) and the base side (lower limit) of the result of operation used for control operation can be set. This scale becomes the scale of PID operation.

3) UCd1 (Ch8-91)

- Select the decimal point position of the result of Math operation.

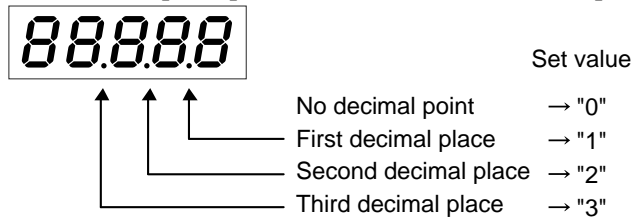

If CALC (CH8-88) is set to 0 (no operation) when TPLT is set to 50 or 51, PV1 becomes the result of operation, and the scale used for PID operation becomes UCF1 (Ch8-89), UCB1 (Ch8-90) and UCD1 (Ch8-91).



4) k01 (Chd-1) to k16 (Chd-16)

- Substitute proper values into constant k01 (Chd-1) to k16 (Chd-16).

[Setting method]

Setting method of constant is different from the method of setting other parameters.

Press the  key, and digit selection is changed in the order from the 1st, 5th, decimal point, 4th, 3rd, 2nd, and back to the 1st.

Press the  key to move the decimal point to the left, and press the  key to move it to the right. When it is moved to the end, it is then moved to the other end.

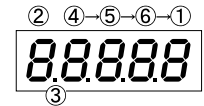

5-15 Remote operation prohibition

rih1 Remote operation prohibition setting (Setting range: ON, OFF)

[Description]

1) rih1 (Ch9-7)

- Remote operation can be prohibited. (See the following table.)
- Use this function when remote operation function is not required.

| rih1 | Remote operation |
|------|------------------|
| OFF | Allowed |
| ON | Prohibited |

When rih1 is set to ON, R-ACK of Di function, SV selection of Di function, remote operation function with REM1 parameter, and remote operation function at the time of power ON cannot be used.

5-16 Remote acknowledge (R-ACK) function

rAC1 Setting of permission of switching to remote operation with Di (Setting range: EnA, inh)

[Description]

1) rAC1(Ch9-11)

- Setting of permission of switching to Remote/Auto operation can be made with Di.
- To use this function, set TPLT (Ch8-92) to 50 or 53, rAC1 (Ch9-11) to EnA, rEM (Ch1-1) to rEM, and 60 (Remote acknowledge) to either of Di01 to Di15 (Ch9-39 to 47).

| Setting | Explanation |
|--------------|----------------------------------|
| EnA (Enable) | “Remote mode” allowed with Di |
| Inh (inhblt) | “Remote mode” prohibited with Di |

| Operation mode | Di (R-ACK) | Indication lamp status |
|----------------|------------|--------------------------------|
| Remote Auto | ON | R ON, |
| | OFF | R flickers, A ON |
| Manual | ON | M ON, R flickers |
| | OFF | M ON, A flickers |

5-17 Manual operation prohibition

A-n1 Setting manual operation prohibition (Setting range: A-M, A)

[Description]

1) A-M1(Ch9-15)

- Manual operation can be prohibited. (See the following table.)
- Use this function when manual operation function is not required.

| Setting | Manual operation |
|---------|------------------|
| A-M | Allowed |
| A | Prohibited |

When manual operation is prohibited, forced manual operation (SMV) and manual power ON by Di function cannot be performed.

5-18 Operation mode at the time of power ON

Cnd1 Operation mode setting at the time of power ON (Setting range: A, R, M)

[Description]

1) **Cnd1(Ch9-19)**

- Operation mode at the time of power ON can be set.
 - Operation mode can be selected from the following three option below.
 - A: Auto operation
 - R: Remote operation
 - M: Manual operation

 - Setting Cnd1 to R (Remote operation)
Under Remote operation prohibition setting, the instrument is started by Manual operation when SMV of Di function is set to ON, and in other cases, it is started by Auto operation.
 - Setting Cnd1 to M (Manual operation)
Under Manual switching prohibition setting, the instrument is started by Remote operation when R-Ack of Di function is set to ON and rEM1 (Ch1-1) is set to rEM in SV selection, and in other cases, it is started by Auto operation.
- * See section 4-1 “Auto operation,” section 4-2 “Manual operation,” and section 4-3 “Remote operation” for details of each operation.

5-19 SV tracking function

Trk1 SV tracking function ON/OFF setting (Setting range: ON, OFF)

[Description]

1) TRK1(Ch9-23)

- Tracking of RSV (remote SV) to LSV (local SV) is allowed when operation is switched from Remote to Auto, which is called SV tracking function.
 - ON: Tracking is performed. (Local SV = Remote SV)
 - OFF: Tracking is not performed. (Local SV \neq Remote SV)
- Local value at the time of switching to remote operation is restored.

[Example]

When TPLT (Ch8-92) is set to 50 or 53, Local SV is set to 200.0, and Remote SV is set to 0.0

When Trk1 = ON

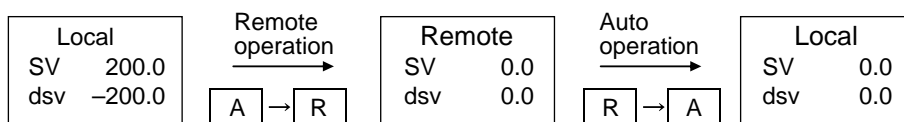

When Trk1 = OFF

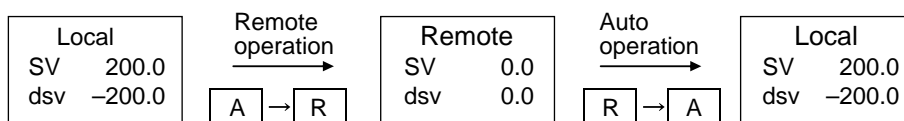

* See section 3-1 “Setting control template” for details of TPLT (Ch8-92).

[Note]

- If setting is changed from Remote SV to Local SV during Manual operation, the instrument operates as shown above.
- During Remote operation, SV tracking setting is used when setting is changed from Remote SV to Local SV both in auxiliary input Ai1 and SV selection methods.
- When operation is switched to remote SV operation during Ramp/soak and then switched to local SV operation again, SV value will be switched to Ramp/soak SV value even though SV tracking function is set to ON.

5-20 Password

PS1 PS2 Password entry (Setting range: 0000 to FFFF)

PAS1 PAS2 PAS3 Password setting (Setting range: 0000 to FFFF)

[Description]

1) PS1-PAS1 (The function prevents people other than the administrator from changing the setting of this instrument.)

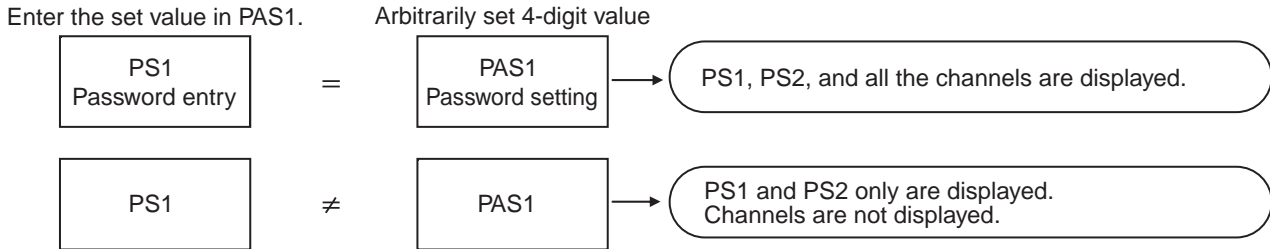

* Please be sure to note the registered password.

2) PS2-PAS2 (The function prevents people other than the administrator from changing the settings except for Ch1 oPE (operation parameter).)

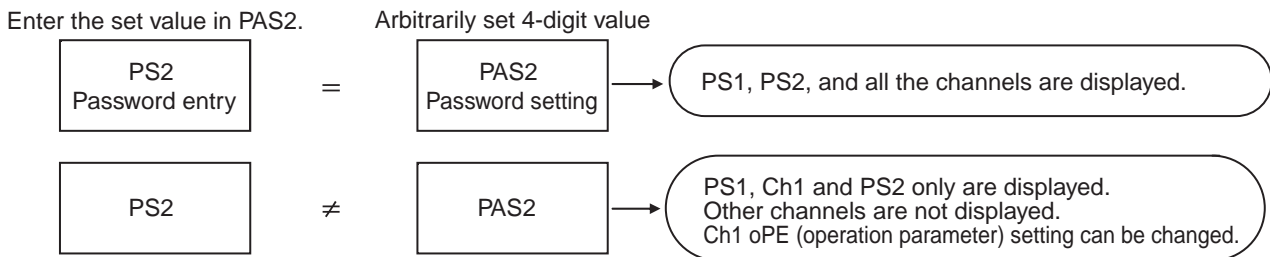

* Please be sure to note the registered password.

[Note]

- If the password is lost,

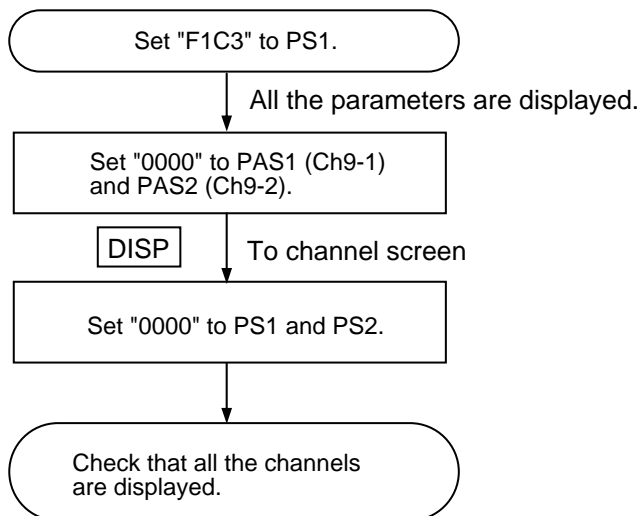

- * If "F1C3" is selected, parameters not displayed in normal times are displayed. Never change the parameters that are not displayed in normal times. Otherwise a failure may occur.
- * PAS3 is for maintenance work. Never change the setting. Otherwise a failure may occur.

5-21 Parameter mask

ds00 to ds43 Parameter mask setting (Setting range: 0000 to FFFF)

[Description]

1) ds00(Ch9-80) to ds43(Ch9-C3)

- Unnecessary (unused) parameters can be masked (non-display).
- This function can be used to prevent settings from being changed by mistake.
- See “Display mask” in the parameter list for correspondence between ds00 (Ch9-80) to ds43 (Ch9-C3) setting and parameters to be masked (non-display).
- See the following setting example for setting method.

[Setting example]

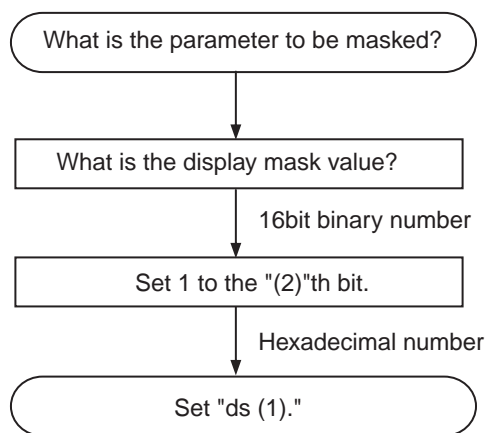

[Example] TC1

Parameter mask definition is below.
(See Appendix2 Parameter List.)

| | | | | | |
|-------------------------------|-----------|------------------|-----------|--------------------------------|--|
| $\frac{03}{(1)}$ | - | $\frac{13}{(2)}$ | | | |
| 4th digit | 3rd digit | 2nd digit | 1st digit | Digit of hexadecimal number | |
| 13 | 9 | 5 | 1 | No. of digits of binary number | |
| 0 0 0 1 | 0 0 0 0 | 0 0 0 0 | 0 0 0 0 | Binary number | |
| 1 | 0 | 0 | 0 | Hexadecimal number | |
| 1000(16) | | | | | |
| ↓ | | | | | |
| Set 1000 to ds03 to mask TC1. | | | | | |

Note:

- When the setting of the parameter (dsxx) whose setting is to be changed is other than 0, add current set value to the value calculated as shown above.

Factory-set value of ds00 to ds43

| ds | Set value | ds | Set value | ds | Set value | ds | Set value | ds | Set value |
|----|-----------|----|-----------|----|-----------|----|-----------|----|-----------|
| 00 | 8000 | 10 | 0002 | 20 | 0038 | 30 | 00EE | 40 | 00FC |
| 01 | 002E | 11 | 0002 | 21 | 0038 | 31 | 0404 | 41 | 01FF |
| 02 | 0000 | 12 | 0002 | 22 | 01FF | 32 | 1D00 | 42 | 01FF |
| 03 | 4622 | 13 | 0002 | 23 | 001A | 33 | 0000 | 43 | 01FF |
| 04 | FFFF | 14 | 0002 | 24 | 01dF | 34 | FF00 | | |
| 05 | FFFF | 15 | 0000 | 25 | 80FC | 35 | 0003 | | |
| 06 | FFFF | 16 | 003E | 26 | 0018 | 36 | 0C31 | | |
| 07 | 0002 | 17 | 0E24 | 27 | 0EEE | 37 | 0314 | | |
| 08 | 0002 | 18 | 000E | 28 | 0E0E | 38 | 0010 | | |
| 09 | 0002 | 19 | 0002 | 29 | 0007 | 39 | 0076 | | |

- Do not display parameters masked at the time of delivery and change the setting. Otherwise a failure may occur.

5-22 EX-MV function

EXM1 External manipulated value setting (Setting range: -25 to 125%)

[Description]

1) EXM1(Ch2-97)

- In this mode, the instrument is operated with the MV value set according to the value of external manipulated value EXM1.
- During EX-MV operation, ordinary MV follows EX-MV.
- To set the control mode to EX-MV, set the EX-MV value and then set Di to ON.

| Di input | Output signal |
|----------|-----------------|
| OFF | MV (PID result) |
| ON | EX-MV |

- * During Manual operation, if Di allocated with EX-MV is set to ON, EX-MV is not output, but MV set on the operation screen (Manual MV) is output.
- * Allocation is made to Di4 of each template at the time of delivery.
If EX-MV value is not output when Di4 is set to ON, check if EX-MV (103) is allocated to Di (Ch9-39 to 47).

5-23 Setting 2 degrees of freedom PID

ALP1 2 degrees of freedom coefficient α setting (Setting range: -300.0 to 300.0%)

bET1 2 degrees of freedom coefficient β setting (Setting range: 0.0 to 900.0%)

[Description]

The function is used to suppress overshoot generated in PID control.

The 2 degrees of freedom PID system of this instrument adopts set value (SV) filter method, which is effective at suppressing overshoot at the time of setting change or power ON.

If ALP1 (α) is set to 100.0% , and bET1 (β) to 0.0% , ordinary PID control (1 degree of freedom PID) is performed.

Adjust ALP1 (α) and bET1 (β) as follows.

- 1) Set ALP1 (α) to 40.0% , and bET1 (β) to 100.0% .
- 2) Perform control and check responsibility (overshoot volume).

If overshoot cannot be improved in this stage, adjust ALP1 (α) and bET1 (β), following the definition listed in the following table.

If ALP1 (α) is generally not required adjusting.

Therefore, it is recommend that you to use the instrument with ALP1 (α) set to 40.0% .

| Result of control | bET1 | ALP1 |
|-------------------|----------------------------------|-----------------------------------|
| Large overshoot | Increase BET1 (β) by 20% | Decrease ALP1 (α) by 10% |
| Small overshoot | Decrease BET1 (β) by 20% | Increase ALP1 (α) by 10% |

[2 degrees of freedom PID block diagram]

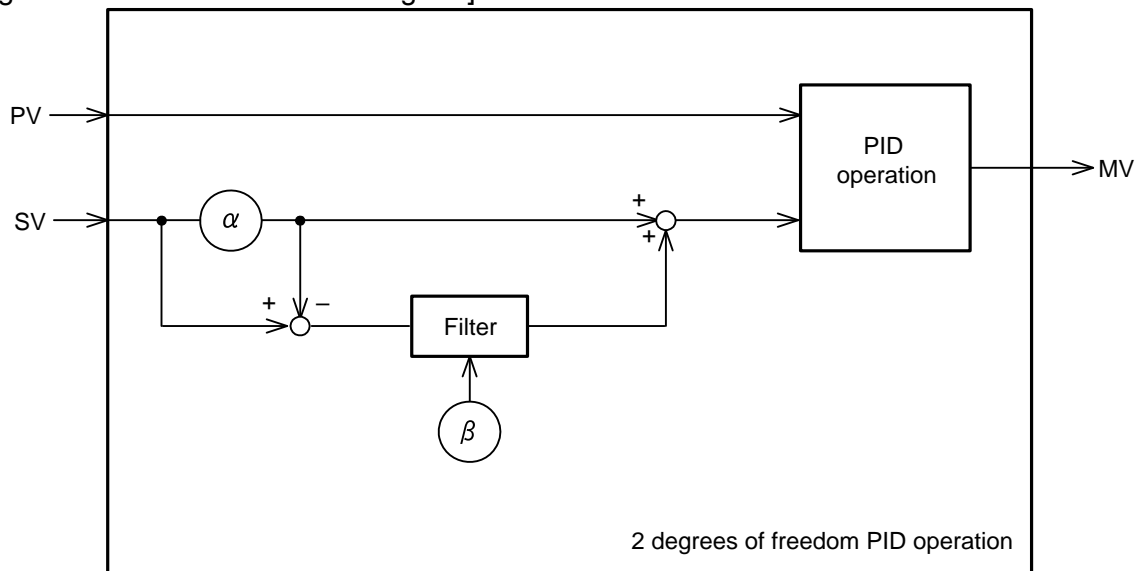

[Note]

- * Change the setting of ALP1 (α) in manual mode.

Before changing ALP1 (α) setting, set bET1 (β) to 0.0% . Change ALP1 (α) setting, and then set desired value to bET1 (β) again. Improper procedure may cause output (target value) to increase temporarily, thus posing danger.

- * The purpose of this function is to suppress overshoot generated in ordinary PID control. Overshoot may not always be eliminated.

5-24 Screen display selection function

odSP Operation display setting (Setting range: 000 to 111)

[Description]

Items to be displayed on the operation screen can be selected with parameters.
 Make the following parameter setting for operation display setting odSP (Ch9-79).

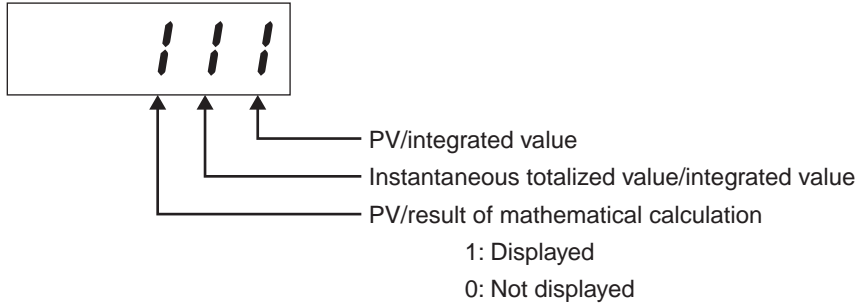

The display shifts as follows during operation.

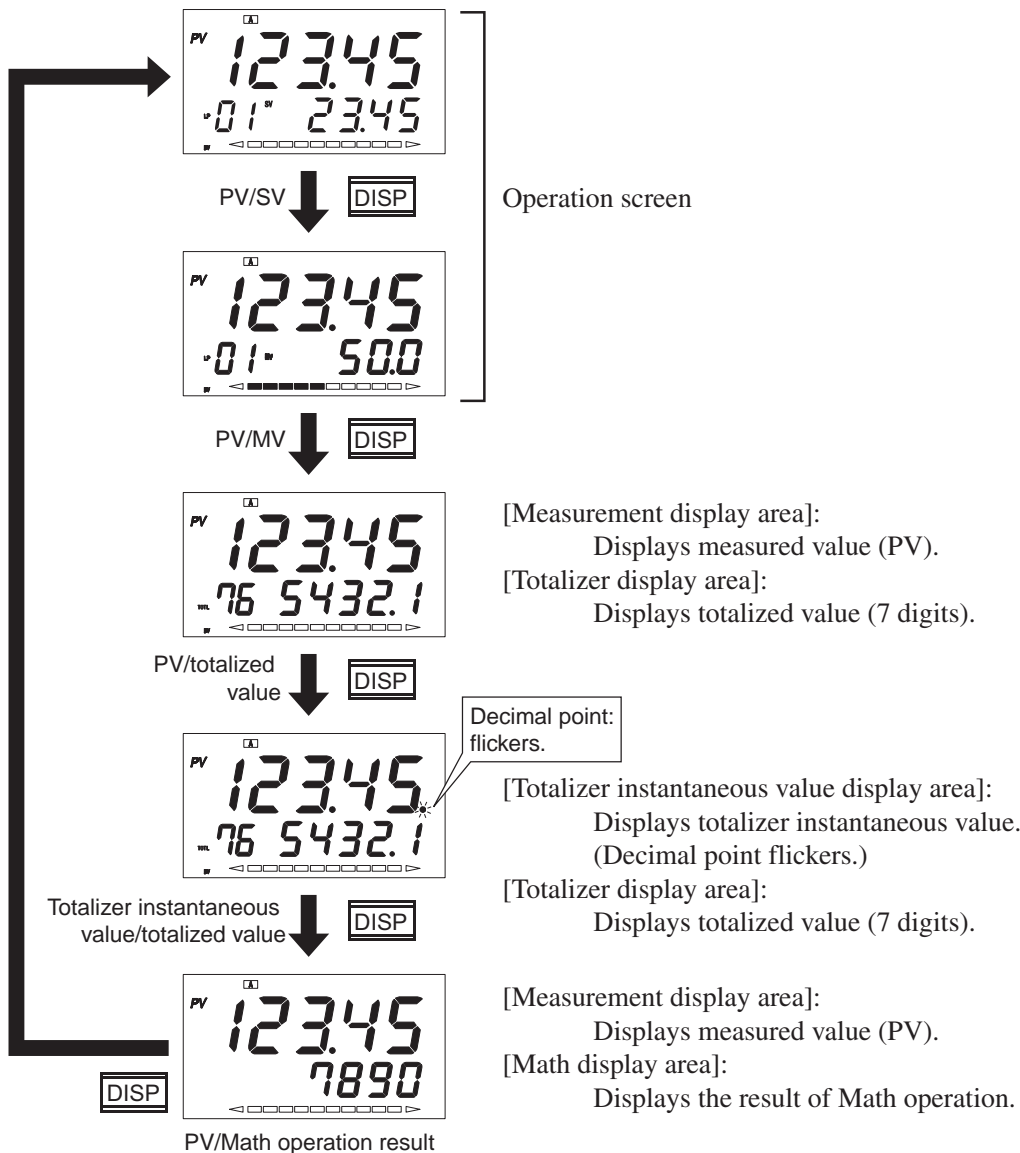

5-25 Totalizer function

[Description]

Description of totalizer function

The totalizer function can be used to select one point from PV1, PV2, Ai1, and AiM, and totalize the input values. The totalized value can be displayed on the screen.

Totalized value display

PV/totalized value display and totalizer instantaneous value/totalized value display can be displayed on the operation screen using the screen display selection function odSP (Ch9-79).

Switching is made every time the DISP key is pressed on the operation screen.

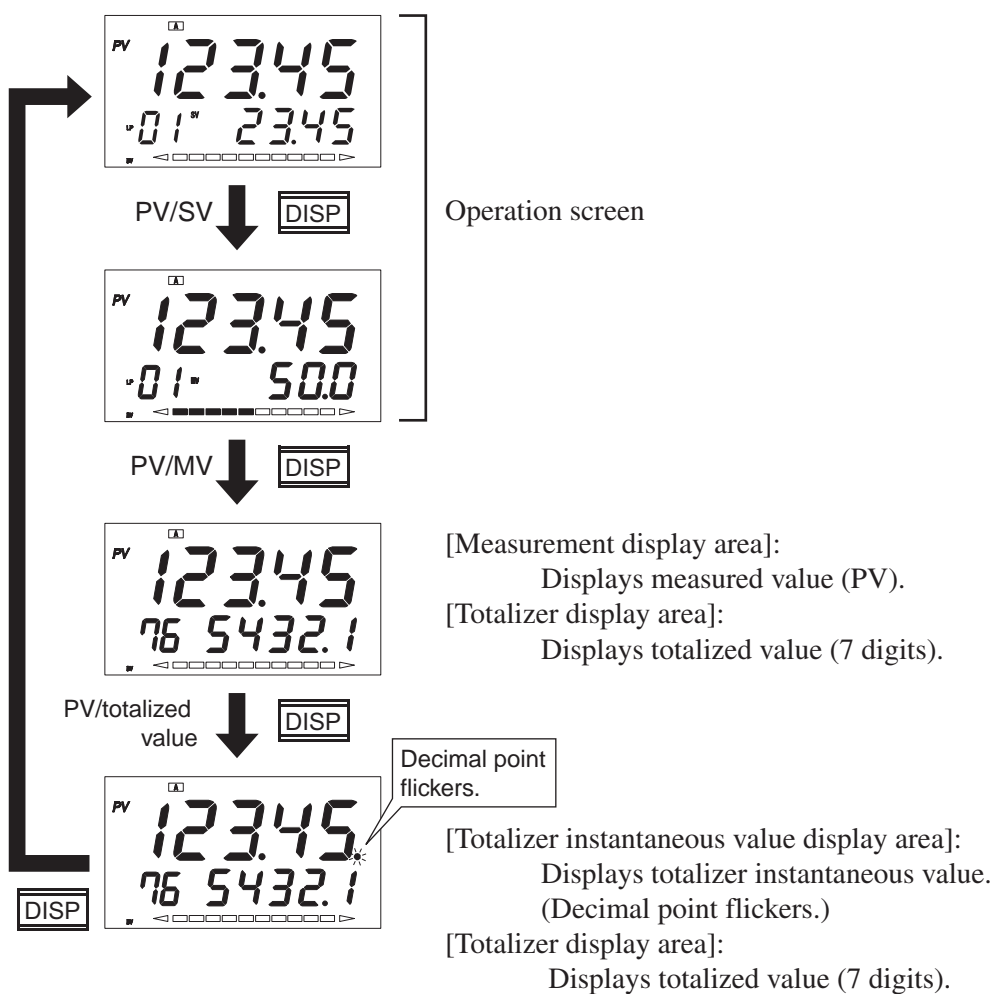

TMod Totalizer operation mode setting (Setting range: 0, 1)

[Description]

The totalizer function is available in 2 modes, Japanese mode and English mode. Mode selection is allowed by parameter setting. Description of each mode and setting method are described below.

1) Japanese mode

Calculation is carried out using totalizing factor.

Totalizing factor TCF (ChG-17): Sets the totalized value display when 100% input is continued for 1 hour. (Setting range: 20 to 9999999)

2) English mode

Totalized value display by totalizer reference time, integration divisor, and integration multiplier

Totalizer reference time Tb (ChG-14): Sets the reference time of input signals. Integrated value per reference time is displayed.

(Setting range: sec/min/hour/day)

Scaling value SCL (ChG-15): Divisor for integrated value scale conversion. The value divided by the divisor is used as integrated value.

(Setting range: 0 to ±1000000)

Input multiplier MUL (ChG-16): Multiplier for integrated value scale conversion. The value multiplied by the multiplier is used as integrated value.

(Setting range: 0 to ±1000000)

$$\frac{\left(\begin{array}{|c|} \hline \text{Input value} \\ \hline \text{(Engineering value)} \end{array} \right) \times \left(\begin{array}{|c|} \hline \text{Input multiplier} \\ \hline \text{MUL} \end{array} \right) + \left(\begin{array}{|c|} \hline \text{Remainder of} \\ \hline \text{previous operation} \end{array} \right)}{\left(\begin{array}{|c|} \hline \text{Totalizer} \\ \hline \text{time base Tb} \end{array} \right) \times \left(\begin{array}{|c|} \hline \text{Scaling value SCL} \\ \hline \end{array} \right)} + \text{Previous totalized value} = \text{Totalized value}$$

TMod(ChG-12)

| Setting | Setting contents |
|---------|------------------|
| JPn | Japanese mode |
| EnG | English mode |

rUn Totalizer RUN/HOLD and LATCH (Setting range: HoLd/rUn/LATcH)

[Description]

1) TrUn (ChG-1)

Totalizer is started/stopped and latched as follows.

- When power is turned on: Selection can be made from RUN and HOLD.
- During standby: Totalizer is not performed during standby. RESET operation is allowed. Since totalizer alarm is set to OFF during standby, alarm judgment is not made.
- Totalizer operation is continued in other modes.

| Parameter | Operation |
|-----------|---|
| RUN | Starts totalizer, makes totalizer alarm judgment. |
| HOLD | Stops totalizer, continues instantaneous value display, holds totalizer alarm output. |
| LATCH | Stops totalizer display, continues totalizer, stops instantaneous value display, continues totalizer alarm operation. |

2) Allocation to Di function

- Operation can be allocated to Di.
- The following totalizer operations can be allocated to parameters Di01 (Ch9-39) to Di04 (Ch9-42) and Di11 (Ch9-43) to Di15 (Ch9-47).

| Di setting Di1 to Di15 | Di input | |
|---------------------------|----------|-------|
| | OFF | ON |
| 160 | RUN | HOLD |
| 161 | RUN | LATCH |

[Note]

- If RUN/HOLD and RUN/LATCH functions are allocated to Di at the same time, the one with larger Di number takes precedence in operation over the other.
- If RUN/HOLD and RUN/LATCH functions are allocated to Di, parameter setting or allocation to function keys cannot be performed.

3) Allocation to function keys

- Totalizer operation can be allocated to function keys.
- The following totalizer operations can be allocated to parameters F1 (Ch9-32) to F3 (Ch9-34).]

| Function key code, F1 to F3 | Function |
|--------------------------------|-------------|
| 30 | RUN / HOLD |
| 31 | RUN / LATCH |

5. ADVANCED USAGE

TrES Totalizer reset (Setting range: ON, OFF)

[Description]

1) TrES (ChG-2)

Totalizer can be reset.

ON: Clears totalized value, totalizer alarm OFF

Automatically returns to OFF state after the reset.

2) Allocation to Di function

- Reset function can be allocated to Di.
- The following Di settings can be allocated to parameters Di01 (Ch9-39) to Di04 (Ch9-42) and Di11 (Ch9-43) to Di15 (Ch9-47).

| Di setting Di1 to Di15 | Di input | |
|---------------------------|----------|-------|
| | OFF | ON |
| 162 | — | Reset |

3) Allocation to function keys

- Totalizer operation reset function can be allocated to function keys.
- Totalizer reset function can be allocated to parameters F1 (Ch9-32) to F3 (Ch9-34).

| Function key code, F1 to F3 | Function |
|--------------------------------|-----------------|
| 32 | Totalizer reset |

ToIn Totalizer input source setting (Setting range: PV1, PV2, Ai1, AiM)

[Description]

ToIn (ChG-3)

- Input source used for totalizer can be selected.
- Select one from PV1, PV2, Ai1, and AiM as totalizer input.

| Parameter | Input source |
|-----------|--------------------------|
| PV1 | Measurement input 1 |
| PV2 | Measurement input 2 |
| Ai1 | Auxiliary analog input |
| AiM | Result of Math operation |

r d P Totalizer decimal point position setting (Setting range: 0 to 4)

[Description]

TdP (ChG-4)

Decimal point position in totalized value display can be set.

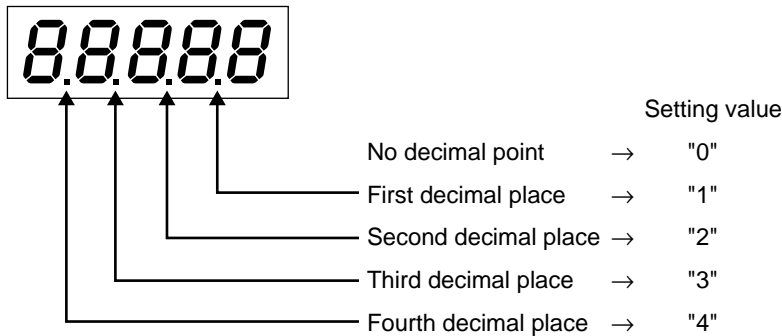

[Note]

- Once the decimal point position is changed, the decimal point position of totalizer conversion factor (TCF (ChG-17)), totalizer initial value (TihT (ChG-18)), totalizer alarm 1 setting (A1SP (ChG-19)), totalizer alarm 2 setting (A2SP (ChG-20)), and re-transmission output source scale (rTSc (ChG-21)) is also changed. Check the decimal point position of each parameter.
- In the case of English operation mode, once the decimal point position is changed during totalize operation, the digit of totalizer is changed. Be sure to reset the totalized value before changing the decimal point position.

r C U F Integration cut point setting (Setting range: 0 to 100%FS)

[Description]

TCUT (ChG-5)

Integration cut point for totalizer input can be set.

Input lower than the integration cut point is not added to totalized value.

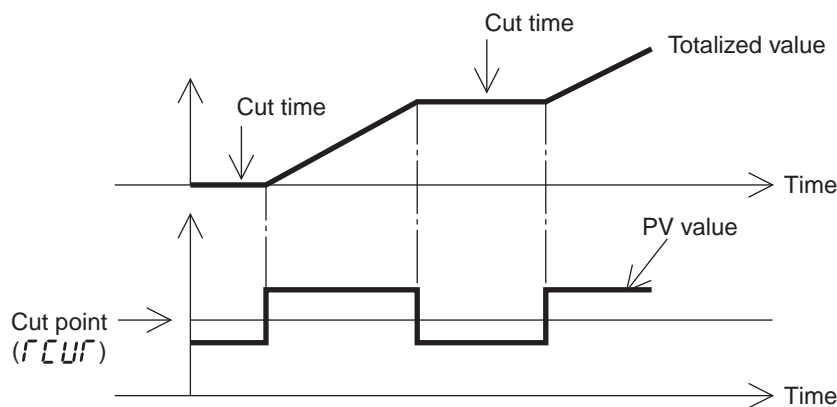

[Note]

- In the case of English operation mode, if minus value is selected, the integration cut point becomes 0.
- The decimal point appears according to the decimal point position setting of measurement input.

5. ADVANCED USAGE

A1TP Totalizer alarm 1 alarm type setting (Setting range: 0 to 3)

A2TP Totalizer alarm 2 alarm type setting (Setting range: 0 to 3)

[Description]

A1TP (ChG-6), A2TP (ChG-9)

- Alarm type of totalizer alarms 1 and 2 can be set.
The alarm type can be selected from the three types listed in the following table.

| A1TP A2TP | Alarm type |
|--------------|--|
| 0 | No alarm |
| 1 | Totalized value alarm |
| 2 | Batch control output |
| 3 | Batch control output (with auto reset) |

1) Totalized value alarm output

- Plus alarm setting: Alarm comes ON when totalized value > alarm setting.
- Minus alarm setting: Alarm comes ON when totalized value < alarm setting.
Totalized alarm is set to OFF by reset input TrES (ChG-2).
Or, it is also set to OFF by auto reset, display overflow reset, or setting the totalizer initial value at which alarm comes OFF.

2) Batch control output

- Plus alarm setting: Alarm comes ON when integrated value > alarm setting.
- Minus alarm setting: Alarm comes ON when integrated value < alarm setting.
Select pulse width from parameters A1on (ChG-7) and A2on (ChG-10).
(100ms/200ms/500ms/1s/Continuous)
If continuous output is set to pulse width, alarm output is set to OFF by performing totalizer reset TrES (ChG-2).

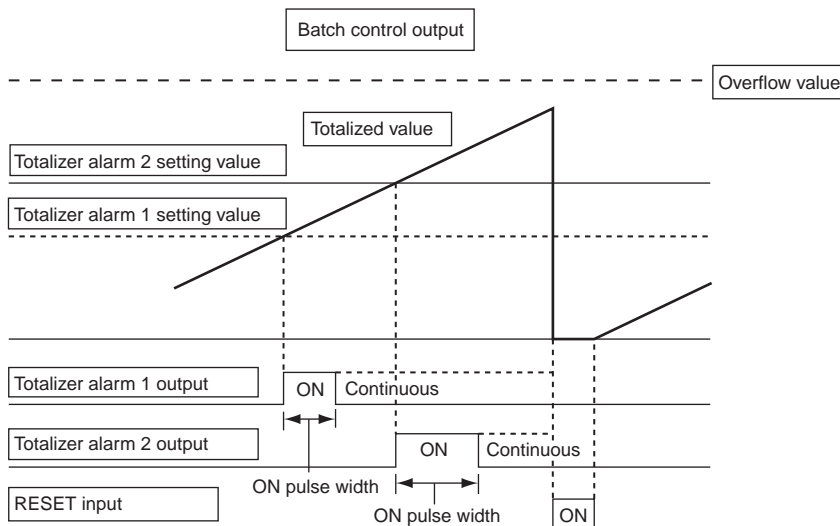

Note: The pulse width error falls within 0 to 50msec.

3) Batch control output (with auto reset)

- Plus alarm setting: Alarm is set to ON when integrated value > alarm setting.
 - Minus alarm setting: Alarm is set to ON when integrated value < alarm setting.
- Select pulse width from parameters A1on (ChG-7) and A2on (ChG-10).
(100ms/200ms/500ms/continuous)

If the pulse width is set to continuous, alarm output is set to OFF by performing totalizer reset TrES (ChG-2).

Auto reset function: Resets the totalizer when the alarm output comes ON.

If the pulse width is set to continuous, totalizer alarm is not set to OFF at the time of auto reset.

OFF action of the batch control output

| Alarm ON pulse width | by Auto reset | by Reset input |
|----------------------|--|----------------|
| Continuous output | Not set to OFF. | OFF |
| Others | Set to OFF after the output of ON pulse width irrespective of reset input. | |

When the totalizer initial value is the same or larger than the alarm setting, resetting is made immediately and the totalizer starts from 0.

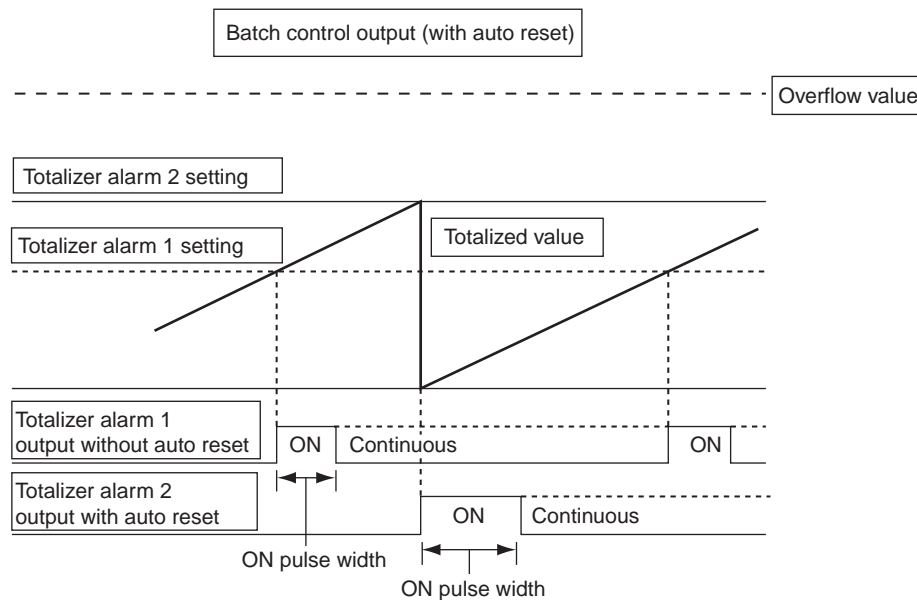

Note: The error of pulse width falls within 0 to 50msec.

5. ADVANCED USAGE

A1on Totalizer alarm 1 ON pulse width setting (Setting range: 0 to 4)

A2on Totalizer alarm 2 ON pulse width setting (Setting range: 0 to 4)

[Description]

A1on (ChG-7), A2on (ChG-10)

- The ON pulse width can be set for batch control output of totalizer alarms 1 and 2. The pulse width can be selected from the 5 types listed in the following table.

| A1on A2on | ON pulse width |
|--------------|----------------|
| 0 | Continuous |
| 1 | 100 ms |
| 2 | 200 ms |
| 3 | 500 ms |
| 4 | 1 sec |

A1oP Totalizer alarm 1 excitation, non-excitation setting (Setting range: 0, 1)

A2oP Totalizer alarm 2 excitation, non-excitation setting (Setting range: 0, 1)

[Description]

A1oP (ChG-8), A2oP (ChG-11)

- Excitation or non-excitation output for totalizer alarms 1 and 2 can be set.

| Setting | Setting contents |
|---------|------------------|
| 0 | Excitation |
| 1 | Non-excitation |

When excitation is selected for totalizer alarm

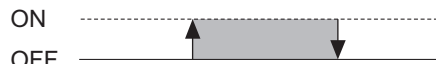

When non-excitation is selected for totalizer alarm

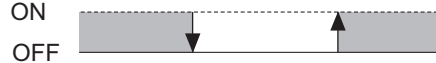

roPr Totalizer option setting (Setting range: 0000 to 1111)

[Description]

ToPT (ChG-13)

Additional functions of totalizer operation can be set.

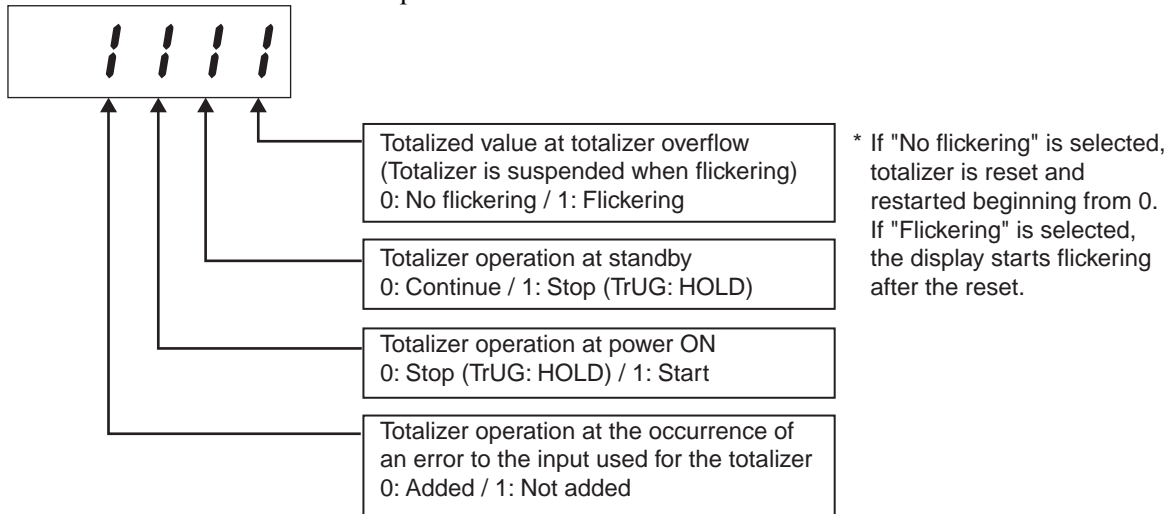

rb Totalizer time base setting (Setting range: SEC, Min, hour, dAY) (only for English mode)

[Description]

Tb (ChG-14)

The unit of integration reference time can be set.

| Time base |
|-----------|
| SEC |
| Min |
| hour |
| dAy |

SCL Totalizer scaling value setting (Setting range: 0 to ± 1000000) (only for English mode)

[Description]

SCL (ChG-15)

- The unit of totalized value can be transformed from the unit of input value.

Example:

| Unit of totalizer input | Unit of totalized value | SCL |
|-------------------------|-------------------------|---------|
| cm ³ | m ³ | 1000000 |
| g | kg | 1000 |

Note: Do not select 0. If 0 is selected, the value is not added to integrated value.

5. ADVANCED USAGE

MUL Input multiplier setting (Setting range: 0 to ± 1000000) (only for English mode)

[Description]

MUL (ChG-16)

- The unit of totalized value can be transformed from the unit of input value.

TCF Totalizer conversion factor setting (Setting range: 20 to 9999999) (only for Japanese mode)

[Description]

TCF (ChG-17)

Integrated value display, when 100% input is continued for 1 hour.

Note: The decimal point position is determined according to the totalizer decimal point position setting TdP (ChG-4).

TinT Totalizer initial value setting (Setting range: -1999999 to 9999999)

[Description]

TinT (ChG-18)

When totalizer initial value is changed, the current totalized value is changed to changed value.

Note: The decimal point position is determined according to the totalizer decimal point position setting TdP (ChG-4).

A1SP Totalizer alarm 1 set value setting (Setting range: -1999999 to 9999999)

A2SP Totalizer alarm 2 set value setting (Setting range: -1999999 to 9999999)

[Description]

1) A1SP (ChG-19), A2SP (ChG-20)

The operation value for totalizer alarms 1 and 2 can be set.

Note: The decimal point position is determined according to the totalizer decimal point position setting TdP (ChG-4).

rTSC Re-transmission output scale setting (Setting range: -1999999 to 9999999)

[Description]

rTSC (ChG-21)

The totalized value can be set so that re-transmission output becomes 100%.

Note: This setting is enabled only when “TV” is selected for re-transmission output type.

Example: When rTSC = 50000L

Output becomes 50% (12mA) when totalized value is 25000L.

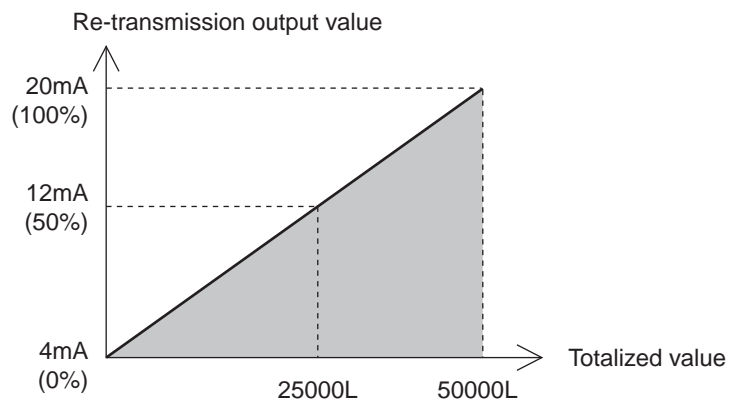

5-26 Recipe function

Description of the recipe function

The recipe function is used to switch the values of the parameters registered as recipe parameters, synchronized with the switching of control palettes.

Select the setting for each control palette for parameters d00 to d79. (Refer to the description on the next page for details.)

rCP0 to rCP9 Recipe allocation (Setting range: 0-00 to W-Z9)

[Description]

1) rCP0 to rCP9 (ChX-1 to 10)

Parameters to be allocated to recipe parameters can be set.

| Symbol | Name | Description |
|--------|----------------------|---|
| rCP0 | Recipe allocation 1 | Select parameter to be allocated as recipe 1 |
| rCP1 | Recipe allocation 2 | Select parameter to be allocated as recipe 2 |
| rCP2 | Recipe allocation 3 | Select parameter to be allocated as recipe 3 |
| rCP3 | Recipe allocation 4 | Select parameter to be allocated as recipe 4 |
| rCP4 | Recipe allocation 5 | Select parameter to be allocated as recipe 5 |
| rCP5 | Recipe allocation 6 | Select parameter to be allocated as recipe 6 |
| rCP6 | Recipe allocation 7 | Select parameter to be allocated as recipe 7 |
| rCP7 | Recipe allocation 8 | Select parameter to be allocated as recipe 8 |
| rCP8 | Recipe allocation 9 | Select parameter to be allocated as recipe 9 |
| rCP9 | Recipe allocation 10 | Select parameter to be allocated as recipe 10 |

Make parameter setting using channel parameter numbers.

[Example] When setting the alarm setting 1 AL1 (Ch1-10) for recipe allocation 1 rCP0

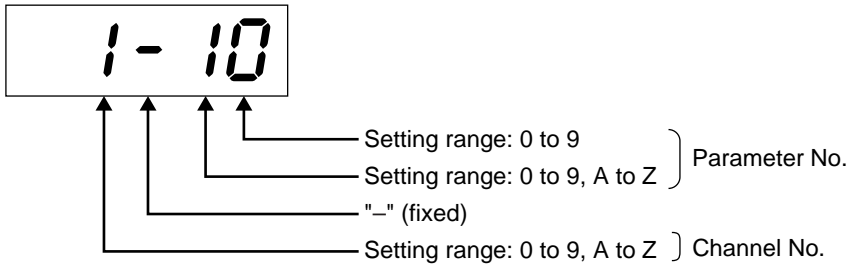

d00 to **d79** Recipe set value setting (Setting range: Depends on the setting range of parameter set in recipe allocation.)

[Description]

Set the value that corresponds to each control palette of parameters allocated to recipe allocation 1 to 10. (The setting range is the same as that of parameters to which recipes are allocated.)

The correspondence between control palette numbers and recipe-related parameters is shown below.

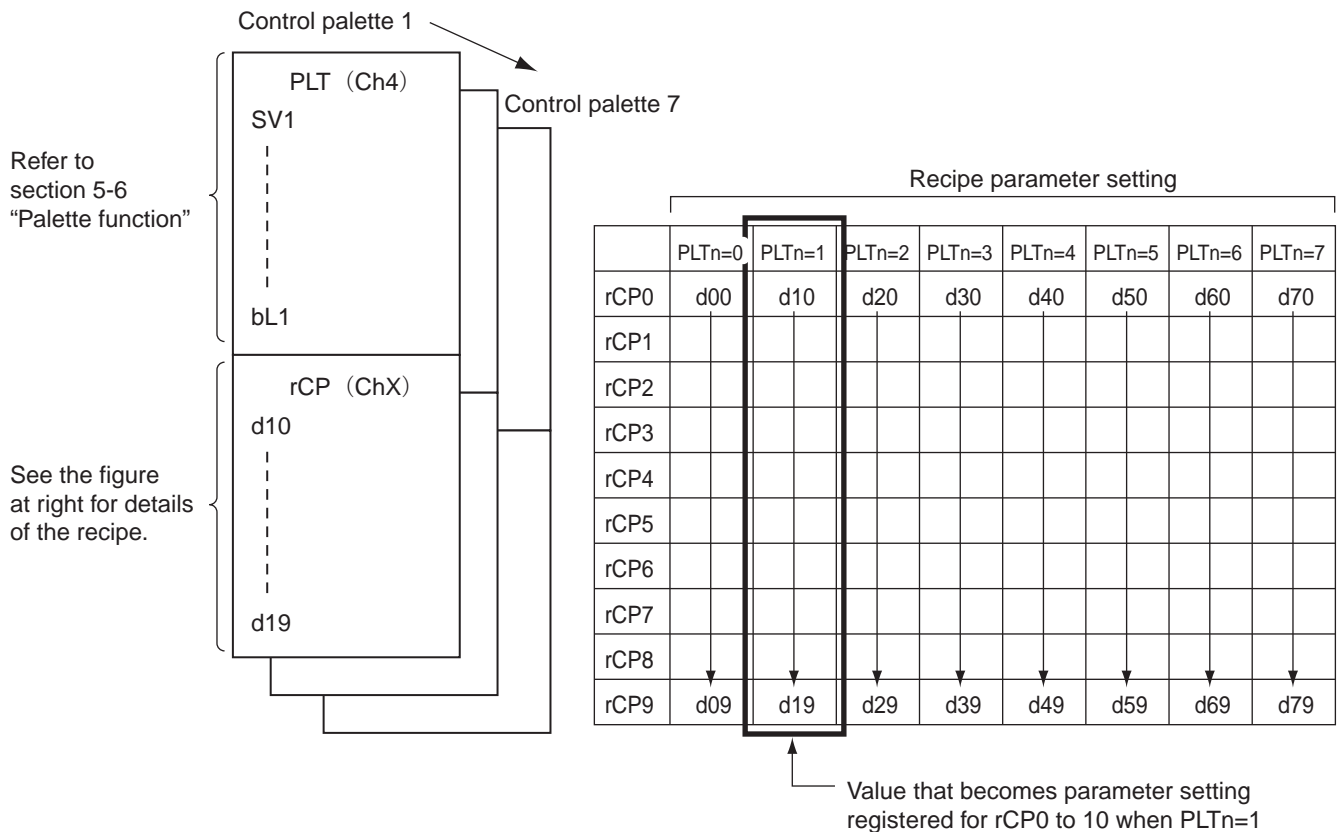

d00 to d79 (ChX-11 to 90)

1) d00 to d09 (ChX-11 to 20): Setting that corresponds to the situation where none of control palettes for recipe allocation 1 to 10 are selected

d10 to d19 (ChX-21 to 30): Setting that corresponds to control palette 1 of recipe allocation 1 to 10

d20 to d29 (ChX-31 to 40): Setting that corresponds to control palette 2 of recipe allocation 1 to 10

d30 to d39 (ChX-41 to 50): Setting that corresponds to control palette 3 of recipe allocation 1 to 10

d40 to d49 (ChX-51 to 60): Setting that corresponds to control palette 4 of recipe allocation 1 to 10

d50 to d59 (ChX-61 to 70): Setting that corresponds to control palette 5 of recipe allocation 1 to 10

d60 to d69 (ChX-71 to 80): Setting that corresponds to control palette 6 of recipe allocation 1 to 10

d70 to d79 (ChX-81 to 90): Setting that corresponds to control palette 7 of recipe allocation 1 to 10

[Note]

- Masked parameters cannot be registered as recipes.
- Recipe allocation setting is enabled after the main unit is reset or power ON again.
- The following parameters cannot be used as recipe parameters. Do not select them for recipe allocation (rCP0 to 9).

5. ADVANCED USAGE

[Parameters that cannot be registered]

| | | |
|-------------------|-------------------|-------------------|
| Ch4 (PLT channel) | Ch7 (MON channel) | Ch8 (SET channel) |
| Ch9 (SYS channel) | ChA (ALM channel) | ChB (Com channel) |
| ChT (TLK channel) | ChX (RCP channel) | |
| STBY (Ch1-5) | AT (Ch1-7) | PLTN (Ch1-9) |
| LACH (ch1-8) | RES (Ch9-E3) | TrUn (chG-1) |
| TrES (chG-2) | TinT (chG-18) | CALB (chF-8) |

[Example]

To change the alarm setting (AL1) to 100.0°C when control palette is not used (PLTn=0), the alarm setting (AL1) to 200.0°C when control palette 1 is selected (PLTn=1), and the alarm setting (AL1) to 300.0°C when control palettes 2 to 7 are selected (PLTn=2 to 7), select recipe-related parameters as follows.

| Parameter | Setting |
|-------------------------------|---------|
| rCP0 (Recipe allocation 1) | 1-10 |
| d00 (Value when PLTn=0 holds) | 100.0 |
| d10 (Value when PLTn=1 holds) | 200.0 |
| d20 (Value when PLTn=2 holds) | 300.0 |
| | |
| | |
| d70 (Value when PLTn=7 holds) | |

5-27 Linearize function

| | | | |
|--------|-----------------------------|---|--|
| $P1Ln$ | PV1 input linearize setting | } | (Setting range: OFF, nrML, hi-C, Lo-C) |
| $P2Ln$ | PV2 input linearize setting | | |
| $A1Ln$ | Ai1 input linearize setting | | |

[Description]

- Linear conversion is performed by 16 straight-line table specific to each input (PV1, PV2, Ai1).
- Select linearize output from the following 3 types.

$P1Ln$ (Ch8-13), $P2Ln$ (Ch8-26), $A1Ln$ (Ch8-51)

Select enable/disable of linearize function of each input.

OFF: Linearize disabled

NrML: Values outside the table range is output without making conversions.

hi-C: Values higher outside the table is limited.

Lo-C: Values lower outside the table is limited.

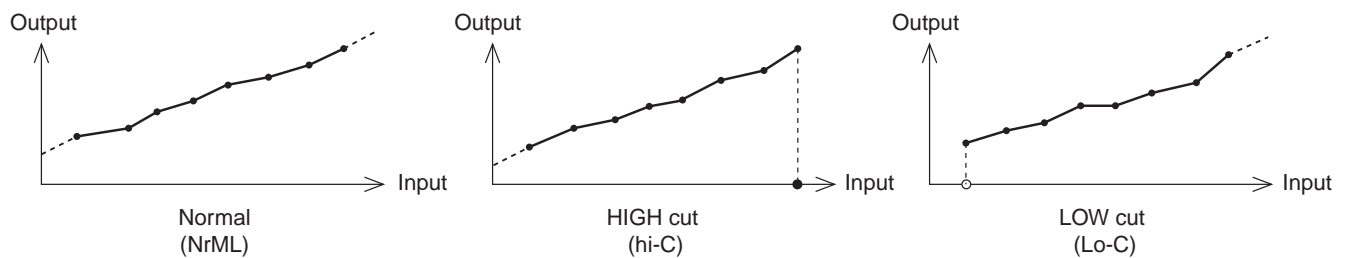

5. ADVANCED USAGE

P 1X0 to **A 1YF** Linearizer table setting (Setting range: -25 to 125%FS)

[Description]

P1X0 to A1YF (ChC-1 to 128)

- 1) The settings of the X-axis and the Y-axis of the linearize table for PV1 input (P1X0 to P1YF), for PV2 input (P2X0 to P2YF), and for Ai1 input (A1X0 to A1YF) are set as follows.
- 2) Sixteen straight-line setting can be made for each table.
- 3) The following table shows the broken-line table.

| Input | Output |
|-------|--------|
| X0 | Y0 |
| X1 | Y1 |
| X2 | Y2 |
| X3 | Y3 |
| X4 | Y4 |
| X5 | Y5 |
| X6 | Y6 |
| X7 | Y7 |
| X8 | Y8 |
| X9 | Y9 |
| XA | YA |
| XB | YB |
| XC | YC |
| XD | YD |
| XE | YE |
| XF | YF |

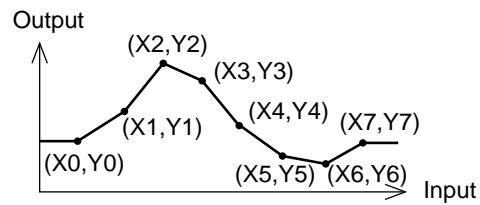

5-28 Data change through communications

(1) MV value setting in manual mode (Setting range: -250 to 1250)

[Description]

If data is written into the manual MV exclusive for communications, the MV value can be changed in manual mode.

* The data is tracked to calculated value MV in modes other than manual mode.

* The data is limited within the range from -25% to 125% if values that do not fall within that range are specified.

(2) Di function through communications

[Description]

In addition to terminals 1 to 4 and Di11 to 15, communication-Di can be used. Communication-Di functions can be allocated to Ci01 to Ci08, (chb-51 to 58).

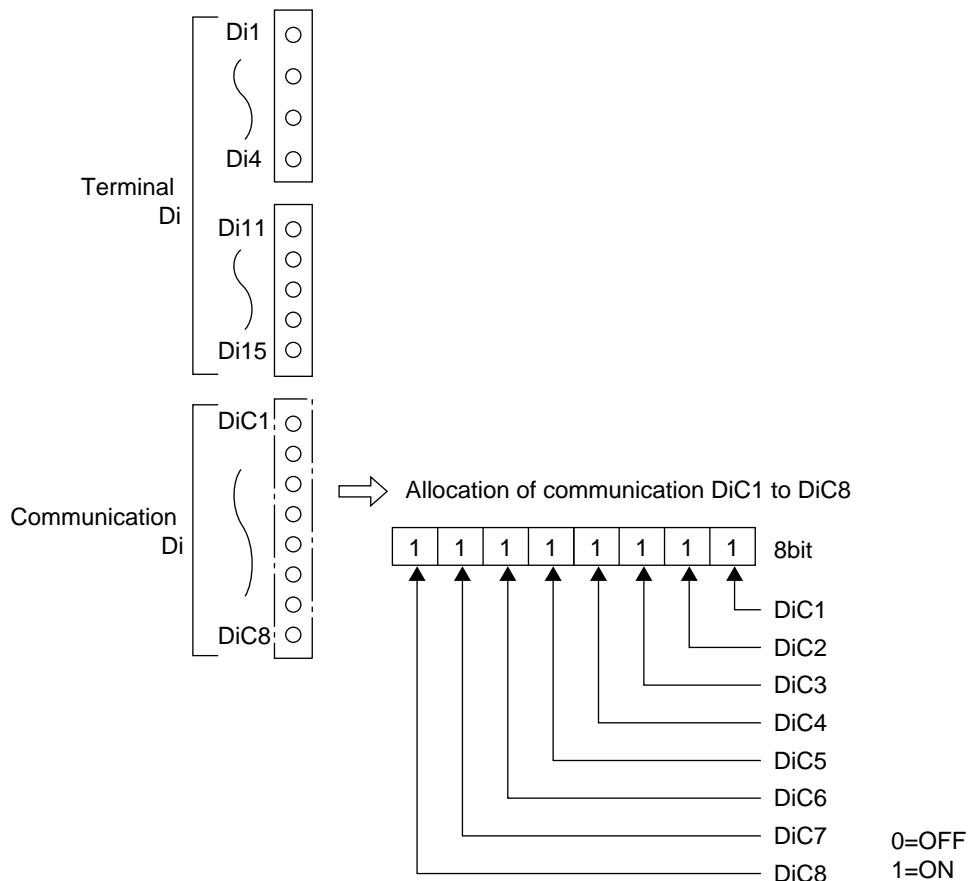

* See the communication manual for MODBUS communication address of communication Di.

5. ADVANCED USAGE

C201 to **C208** Communication Di function setting (Setting range: 0 to 255)

[Description]

1) Ci01 to Ci08 (Chb-51 to 58)

Function setting is the same as Di function setting. (See 5-10 “Digital input (Di) function”.)

(3) RSV change through communications (for Template 16)

[Description]

Change of RSV setting is allowed through communication.

- Select communication RSV using the RSV signal selector switch.

<Setting method>

Set CN02 (ch8-99) = 5.

This allows values to be set through communications.

See the communication manual for the MODBUS communication address of communication RSV.

5-29 Ramp/Soak

- PrC** Ramp/Soak activation Command (Setting range: oFF, rUn, hLd)
- Prn** Ramp/Soak activation Pattern (Setting range: 0 to 30, di)
- rCNU** Ramp/soak time units (Setting range: hh.MM.MM.SS)
- Sv-1** to **Sv64** S V setting value (setting range: 0 to 100%FS)
- rN1r** to **r64r** Ramp time (setting range: 00:00 to 99:59)
- rN1S** to **r64S** Soak time (setting range: 00:00 to 99:59)
- Mod** Ramp/soak mode (setting range: 0 to 15)
- GSot** Guaranty soak ON/OFF (setting range: oFF, on)
- GS-h** Guaranty soak band (upper) (setting range: 0 to 50%FS)
- GS-L** Guaranty soak band (lower) (setting range: 0 to 50%FS)
- PvSr** PV start (setting range: oFF, on)
- Conf** Continue mode (setting range: rES, Con, ini)
- PrnN** Sets the max pattern (setting range: 0 to 30, di)
- PrnCn** Sets the min pattern (setting range: 0 to 30, di)

5. ADVANCED USAGE

[Explanation]

What is Ramp/Soak?

This function automatically runs after setting SV and the times for the SV changes.

SV setting can be set to maximum 64 steps and Ramp/soak activation pattern can be selected from 31 patterns or by specified Di.

(Please refer to "5-10 Digital input (Di) function" regarding Di function)

Additionally, Ramp/soak status can be output from Do.

(Please refer to "5-11 Digital output (Do) function" regarding Do function)

- Ramp: Changing SV tends to reach a target SV
- Soak: Maintains a set SV

The ramp/soak menu (ch8) consists of the following function blocks.

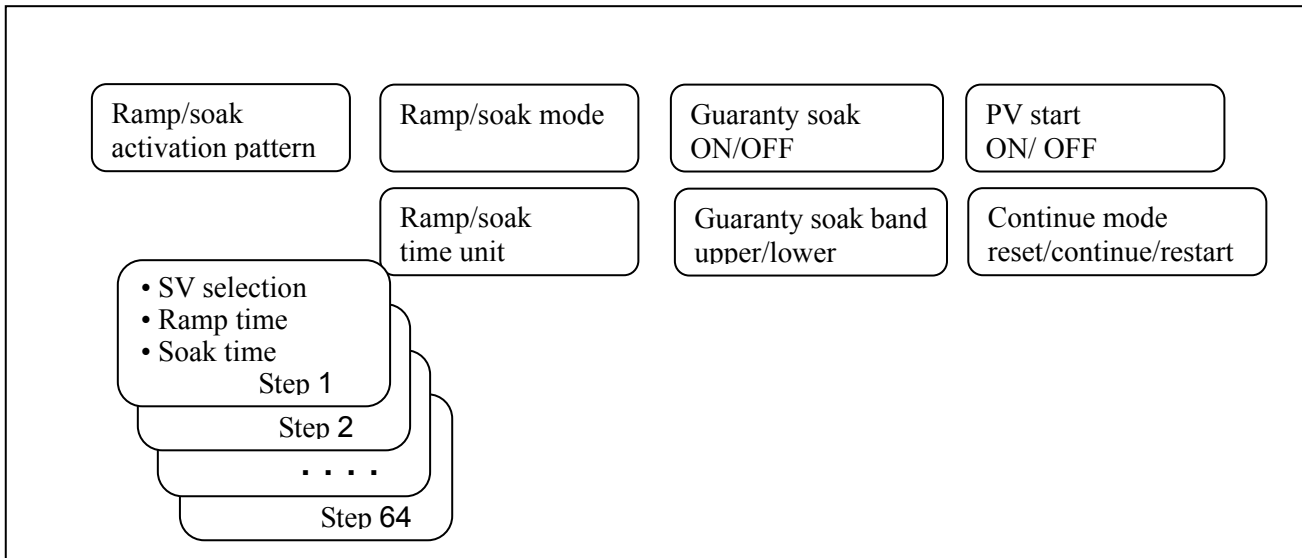

Note

- Even if operation is switched to remote SV operation or manual MV operation during Ramp/soak, Ramp/soak operation will not be stopped. Even Ramp/soak operation is continued and SV is kept changing, remote SV operation or manual MV operation is given first priority to.
- When operation is switched to remote SV operation during Ramp/soak and then switched to local SV operation again, SV value will be switched to Ramp/soak SV value even though SV tracking function is set to ON.

1) PrG (Ch1-6)

– Switch between Ramp/soak states.

Ramp/soak can switch the following three conditions.

| | |
|-----|--|
| PrG | Operation status |
| oFF | Stop: Ramp/soak is stopped. |
| rUn | Run: Ramp/soak starts. |
| hLd | Hold: Ramp/soak hold. To release the hold, select "rUn" again. |

– Parameter will be switched automatically based on Ramp/soak status.

| | |
|-----|--|
| PrG | Status |
| GS | Guaranty soak ON: Guaranty soak is activated and PV is out of guaranty soak setting range. |
| End | End: Ramp/soak ends |

– "RS" ramp lights up as following during Ramp/soak

| Ramp/soak status | Operation screen | others |
|----------------------|------------------|--------|
| oFF (Stop) | OFF | OFF |
| r Un (Run) | blinking | |
| hLd (Hold) | blinking | |
| GS (out of GS range) | blinking | |
| End (End) | ON | |



Note

- Local SV value can not be changed during Ramp/soak operation.
When you change the local SV to given value, make sure to set PrG to "oFF" before change.

5. ADVANCED USAGE

2) PTn (Ch8-1)

- Selects the Ramp/soak activation pattern.

Ramp/soak of following steps will be carried out based on Ramp/soak activation pattern setting.

| PTn | Activation step | PTn | Activation step |
|-----|-----------------|-----|-----------------|
| 0 | 1 ~ 4 | 16 | 1 ~ 8 |
| 1 | 5 ~ 8 | 17 | 9 ~ 16 |
| 2 | 9 ~ 12 | 18 | 17 ~ 24 |
| 3 | 13 ~ 16 | 19 | 25 ~ 32 |
| 4 | 17 ~ 20 | 20 | 33 ~ 40 |
| 5 | 21 ~ 24 | 21 | 41 ~ 48 |
| 6 | 25 ~ 28 | 22 | 49 ~ 56 |
| 7 | 29 ~ 32 | 23 | 57 ~ 64 |
| 8 | 33 ~ 36 | 24 | 1 ~ 16 |
| 9 | 37 ~ 40 | 25 | 17 ~ 32 |
| 10 | 41 ~ 44 | 26 | 33 ~ 48 |
| 11 | 45 ~ 48 | 27 | 49 ~ 64 |
| 12 | 49 ~ 52 | 28 | 1 ~ 32 |
| 13 | 53 ~ 56 | 29 | 33 ~ 64 |
| 14 | 57 ~ 60 | 30 | 1 ~ 64 |
| 15 | 61 ~ 64 | di | specified by Di |

Note

- When Di is selected, make sure to set to "pattern №+1 to 16" by " 5-10 digital input (Di) function" and specify the activation pattern by Di
Additionally, during Ramp/soak operation do not change the Di input status which specify Rmp/soak activation pattern.
- Do not change the PTn setting during Ramp/soak operation.
When you change the setting, make sure to set the PrG to "oFF".

3) TiMU (Ch8-2 to 2)

- Sets the time units when Ramp/soak is activated.

Max. settable time of Ramp/soak is as follows related to setting value.

| TiMU | Time unit | Max. settable time |
|-------|-----------|---------------------|
| hh.MM | hour: min | 99hours 59minutes |
| MM.SS | min: sec | 99minutes 59seconds |

Note

- Time units can not be set separately for each step. All steps use the same unit of time.

- 4) Sv-1 to Sv64 TM1r to T64r TM1S to T64S (Ch8-3 toJ4)
 – Sets the target value (SV value), ramp time and soak time.
 Target value (SV value), Ramp time and soak time can be set up to 64 steps.
 Ramp time is a changing time of SV to reach target SV.
 Soak time is a duration time to maintain the setting SV.

| Parameter | Setting value |
|--------------|--|
| Sv-1 to Sv64 | "SV lower limit (S v L) to SV upper limit (S v h)" |
| TM1r to T64r | "00:00-99:59 (hour:min/min: sec)" |
| TM1S to T64S | "00:00-99:59 (hour:min/min: sec)" |

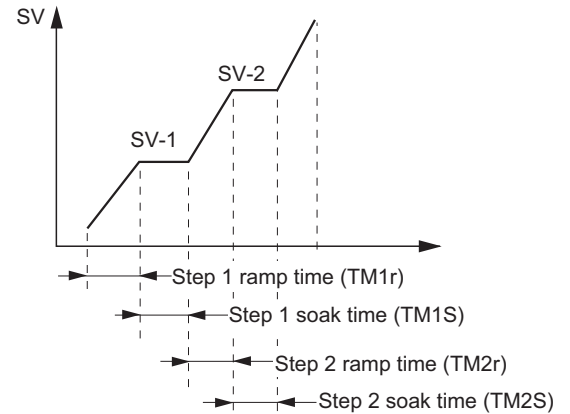

- Both ramp time (TM1r to T64r) and soak time (TM1S~T64S) skip segment 00:00 and proceed the next step.

Sv-1 : 50 Sv-2 : 200 Sv-3 : 100
 TM1r : 0.10 TM2r : 0.00 TM3r : 1.00
 TM1S : 0.05 TM2S : 0.00 TM3S : 0.75

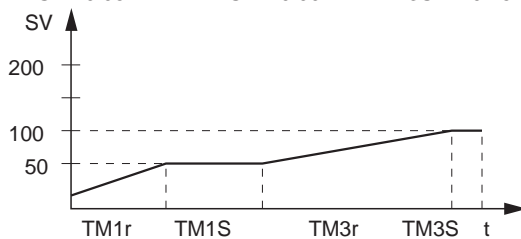

【Note】

- The SV limit function (SV-h, SV-L) is still on while ramp/soak is running.
 The set value (SV-n) does not change, but the value is limited during ramp/soak. For that reason, the value may not change at the set times for the following patterns."

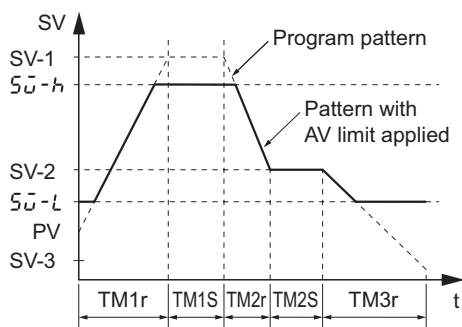

5. ADVANCED USAGE

5) Mod (Ch8-J5)

- Sets the method of ramp/soak operation.

| Function | Description |
|------------------|--|
| Power-on start | Starts ramp/soak from the current PV value when the main unit is turned on. |
| END time output | Maintains the same state as at the end of ramp/soak when ramp/soak is complete. (It is invalid when repeat operation is activated) |
| oFF time output | Switches to the OFF state when ramp/soak is complete. |
| Repeat operation | Repeats ramp/soak from step 1 when the last step finishes. |

There are 16 types of operation modes according to the combination of function as shown blow.

| MOD | Power On Start | Engine Output | OFF Output | Repeat Behavior |
|-----|----------------|------------------|------------------|-----------------|
| 0 | none | Maintain control | Maintain control | none |
| 1 | none | Maintain control | Maintain control | on |
| 2 | none | Maintain control | Standby Mode | none |
| 3 | none | Maintain control | Standby Mode | on |
| 4 | none | Standby Mode | Maintain control | none |
| 5 | none | Standby Mode | Maintain control | on |
| 6 | none | Standby Mode | Standby Mode | none |
| 7 | none | Standby Mode | Standby Mode | on |
| 8 | on | Maintain control | Maintain control | none |
| 9 | on | Maintain control | Maintain control | on |
| 10 | on | Maintain control | Standby Mode | none |
| 11 | on | Maintain control | Standby Mode | on |
| 12 | on | Standby Mode | Maintain control | none |
| 13 | on | Standby Mode | Maintain control | on |
| 14 | on | Standby Mode | Standby Mode | none |
| 15 | on | Standby Mode | Standby Mode | on |

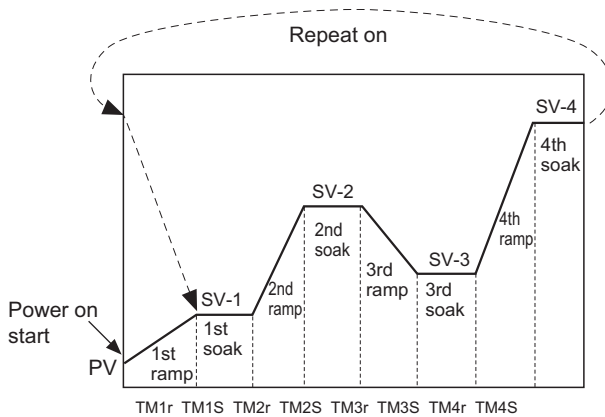

6) Gsok (Ch8-J6) GS-h (Ch8-J7) GS-L (Ch8-J8)

– Sets the Guaranty soak ON/OFF.

Guaranty soak is the function to guarantee soak time.

Soak time is counted down only when PV is in the proper temperature range of SV setting .

In the diagram below, the total of the shaded regions are counted as soak time.

When this total is equal to the specified soak time, the cycle proceeds to the next step.

| Gsok | Function |
|------|------------------------|
| oFF | Disable guaranty soak. |
| on | Enable guaranty soak. |

| Parameter | Setting range |
|-----------|---------------|
| GS-h | 0 to 50%FS |
| GS-L | 0 to 50%FS |

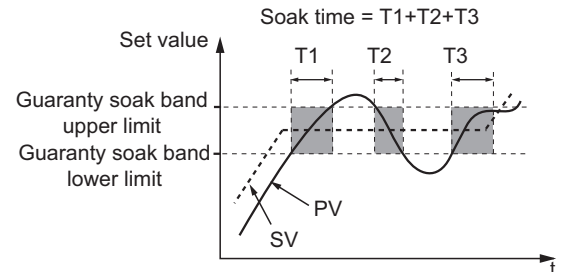

Note

- In guaranty soak, soak time is counted using by SV and PV value where are set at Sv-1 to S v 64.
- For this reason, when you set SV value lower than setting value of Sv-1to Sv64 with SV limit function, please note that soak time may not be counted.

7) PvST (Ch8-J9)

– When the ramp soak starts (RUN), this function searches the first point where the measurement value (PV) and the program pattern match, and starts operation at that point.

| PvST | Function |
|------|----------------------------|
| oFF | Disables PV start function |
| on | Enables PV start function |

Difference of starting position according to PV value

- 1) When PV is matching SV setting value in the program, it will start from Soak period of matching SV.
- 2) When PV is in a range of the SV setting value of the Ramp period, the Ramp is started on the way in the Ramp period.
- 3) When PV does not match SV in the program within the PV input range (PV is lower than SV), Ramp is started from PV value towards to the first target SV.
- 4) When the PV value does not match SV in the program within the PV input range (PV is higher than SV) or PV is an over range, it is started from the Soak period of program SV setting value MAX value.
- 5) When the PV value is under range, it is started from the Soak period of program SV setting value MIN value.

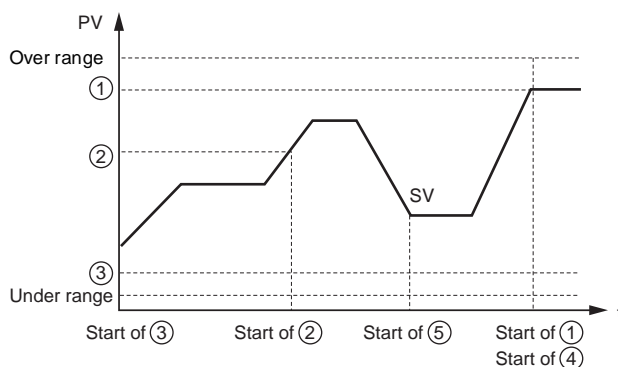

Note

- When ConT(Ch8-K0) is set to "Con", PV start is disabled.

5. ADVANCED USAGE

8) ConT (Ch8-KO)

- When the power turns off during operation due to power outage or other reasons, continue mode can specify the ramp soak operation when the power turns on.
Restore the status up to 5 minutes before.

| Setting value | Operation of continue mode |
|---------------|---|
| rES | Ramp/Soak is not be operated. |
| Con | Continues the operation from the status of the time which power is turned off |
| ini | Starts the Ramp/Soak from the first step again. |

Note

- Do not change the "ConT "during Ramp/soak operation.
Make sure to change while "PrG" is set to "oFF".
- When "ConT" setting is set to "Con", PV start is disabled.
- "ConT" is set to "Con"and when outage occur, restore the status up to 5 minutes before where outage occurred.
- When "ConT" is set to "Con", do not set the Ramp/Soak command (Ch1-6) to "hoLd"frequently more than 10times/per hour.

9) PTnM (Ch8-K1) Pmin (Ch8-K2)

- Sets the max./min. pattern to proceed the Ramp/soak activation pattern with function keys.

| Parameter | Setting range |
|-----------|---------------|
| PTnM | 0 to 30,di |
| PMin | 0 to 30,di |

When you change this setting , make sure to set that "PTnM" (Max.value) is more than "PMin" (Min.value).

Please refer to the "5-13 Function key" regarding user key setting.

Note

- When "di" is selected by PTnM and PMin, Ramp/soak activation pattern specified by Di will be conducted after Ramp/soak activation pattern "30". Tus, when Ramp/soak activation pattern is not specified by Di, do not set the setting value to "di".

6 TROUBLESHOOTING

| Symptom | Possible cause | Remedy | See (page) |
|---|--|---|------------|
| 1. Reading appears as UUUU or LLLL. | (1) Input signal of the sensor and settings of parameter PV1T, PV2T, or AI1T do not coincide. | Make the setting of PV1T, PV2T, and AI1T again. | 27 |
| | (2) Polarity of input signal is reversed. | Check the polarity and connect properly. | 159 |
| | (3) Short circuit occurred to the input of B or R thermocouple (PV1T, PV2T = 4, 5). | Set parameters PV1T and PV2T to 3, and check that temperature around normal temperature is displayed. (The error of B and R thermocouples is extremely large near normal temperature. It is not a failure.) | 27 |
| | (4) Input signal of the sensor and the type do not match. | Ask your distributor for modification, or replace it with a proper type unit. | — |
| | (5) Input connection is loose. | Fasten securely. | — |
| | (6) The sensor is broken or short-circuited. | Replace the sensor, or remove the short-circuited part. | 159 |
| | (7) A device connected to the sensor or the input of the main unit is defective. | Replace the sensor or input devices. | — |
| | (8) Parameter PV1B, PV2B, AI1B or UCB1 is set to the value larger than PV1F, PV2F, AI1F, or UCF1 respectively. | Make the setting again to assure PV1B < PV1F, PV2B < PV2F, AI1B < AI1F, and UCB1 < UCF1. | 27 |
| | (9) Measurement value is too large or too small. | Extend the setting value for parameters PV1B, PV2B, AI1B, UCB1, PV1F, PV2F, AI1F, and UCF1. | 27 |
| 2. Fractional portion of the reading is not displayed. | Parameter, PV1d, PV2D, AI1D, or UCD1 is set to 0. | Set them in the range from 1 to 3. | 27 |
| 3. SV and set value of some of the parameters change spontaneously. | Parameter PV1b, PV1F, or Pv1d has been changed (when TPTL = 53 or 54). Parameter UCB1, UCF1, or UCD1 has been changed (when TPLT = 50 or 51). | Make the setting of all the parameters again. | 160 to 171 |
| 4. ON/OFF control (2-position control) cannot be started. | Parameter P1 is not set to 0.0 (PC1 = 0.0). | Set P1 (PC1) to 0.0. | 93 |
| 5. ON/OFF control does not function. | (1) Setting of parameter hS1 is not correct. | Adjust the setting of hS1 according to the control target. | 95 |
| 6. Control does not function properly. | (1) Setting of parameter P1, i1, or d1 (PC1, iC1, dC1) is not correct. | Do auto tuning. | 55 |
| | (2) Proportion cycle is too long. | Gradually decrease the setting of parameter TC1. | 44 |
| | (3) Output limit is posed. | Make the setting of parameters MVh1 and MVL1 to the value appropriate for the process. | 92 |

6 TROUBLESHOOTING

| Symptom | Possible cause | Remedy | See (page) |
|--|--|--|------------|
| 7. Reaction is slow. (Measurement value changes very slowly.) | Input filter is too large. | Decrease the setting of parameter P1TF. When PV2 or AI1 is used, decrease the setting of P2TF or A1TF. | 90 |
| 8. Reading does not change although output is turned ON/OFF. | (1) Input is short-circuited. | Remove the short-circuited part. | — |
| | (2) Connection with operation terminal is off. | Connect properly. | 159 |
| | (3) Power for the operation terminal is OFF. | Set the power to ON. | — |
| | (4) Output signal and input signal of the operation unit do not coincide. | Provide a thermoregulator appropriate for the operation terminal, or provide operation terminal appropriate for the signals from the thermoregulator. | — |
| 9. Key operation cannot be performed. Parameter value cannot be changed. | Parameter LOC is set to 1, 2, 4, or 5. | Set LOC to 0 or 3. (If LOC is set to 3, setting cannot be made by communication.) | 98 |
| 10. SV cannot be changed. | (1) Parameter LOC is set to 1 or 4. | Set LOC to 0, 2, 3, or 5. | 98 |
| | (2) Setting of values outside the measurement range (parameters Sh1 to SL1) was attempted. | Extend the range of Sh1 and SL1. (Do not extend the range exceeding the values listed in input range table.) | 54 |
| 11. Parameter to be checked or changed does not appear. | Setting has been made to skip the parameters in question with parameters ds00 to ds43. | Change the setting of the parameter in question in ds00 to ds43. | 123 |
| 12. Auto tuning cannot be done properly. | (1) After auto tuning was started, input was set to UUUU. | Expand the range of parameters PV1d, PV1F, and PV1B when TPLT = 53, 54, and expand the range of parameters UCD1, UCF1, and UCB1 when TPLT = 50, 51, and then do auto tuning again. | 27 |
| | (2) After auto tuning was done, SV was changed. | Restore the SV value to be controlled and then do auto tuning again. | 55 |
| | (3) Peripheral devices or connections with those devices are faulty. | Make connections with peripheral devices properly. | — |
| | (4) Forward/reverse operation of thermoregulator and the system of control target do not coincide. | Set parameter rEV1 properly. | 49 |
| | (5) Control target runs out of time in a very slow process (about 17 hours or longer). | Do tuning manually. (Set P1 or PC1 to 0, and perform ON/OFF control.) | 93 |
| 13. Overshoot is too large in auto tuning. | — | (1) Do auto tuning at ATP1 = LPV (low PV type AT). | 55 |
| | — | (2) Do tuning manually. | — |
| 14. Decimal point cannot be changed. | TPLT has been set to 50 or 51. | Set TPLT to 53 or 54, or change the decimal point of UCd1. | 21 or 27 |

Error indications

This Controller has a display function to notify when the equipment is not functioning properly. When a problem occurs, remove the cause immediately.

Once the cause has been removed, turn the power OFF then ON again.

| Display | Cause | Control output |
|--------------------------|---|---|
| UUUU | (1) Thermocouple sensor wire broken (2) RTD wiring broken (3) PV value above upper limit +5%FS or more (4) RCJ sensor not attached (thermocouple input) | MV (operation output) is output with the value of brd1 (ch9-35). (Output type) (1) HOLD, (2) LO (OFF or low limit value of the AO) (3) HI (ON or upper limit value of the AO) (4) EXMV |
| LLLL | (1) Short circuit of resistance bulb sensor (between A and B) (2) When PV value without fractional portion is under -19999. Note) In case of the resistance bulb, LLLL is not displayed even if under -150°C. | Control continues. Note) Control continues until below -5%FS. Burnout occurs at below -5%FS. |
| PV not displaying | Standby mode (PV display set to off) | MV (operation output) is output with the value of PMv1 (ch2-22) or PMC1 (Ch2-37). |
| -19999 or 99999 | Display limit is smaller than over range or under range value. | Control continues. Note) Control continues until under -5%FS or 105%FS. |
| Correct PV not displayed | The main unit was not reset or the power was not turned on after scale setting was changed. | ————— |

7 FREQUENTLY ASKED QUESTIONS

- Q1 Decimal point of the measurement value (PV) started flickering while parameter setting was being changed. What does the decimal point at the far right mean?
A The decimal point at the far right is kept flickering while auto tuning is being performed. Set AT (Ch1-7) to OFF.
- Q2 How is temperature displayed?
A The value rounded off from the lower place value is displayed.
- Q3 Can 105°C be expressed as 60°C?
A It is possible by adjustment by the user. Display can be made in the range of $\pm 50\%$ of the full scale range.
- Q4 What kind of cables should we use for RS485?
A Use twisted pair cables with a shield. Recommended cable: KPEV-SB (By FURUKAWA)
- Q5 PV value has been stably displayed for about a week. Then it increased suddenly for 2 to 3 minutes, and returned back to the original value.
A Effect of noise is considered. Replace the cable with the one provided with a shield.
- Q6 P (PC) is set to 0.0, but ON/OFF display does not appear.
A There is no ON/OFF display. Either of the two output status of MV, 0% (OFF) or 100% (ON) is displayed.
- Q7 Key operation cannot be made.
A The instrument is provided with key lock function, but if the display does not change even if the SEL key is pressed, key failure is considered. Check the type and ask the manufacturer for repair.
- Q8 Reading error of 7 to 8°C is observed.
A The error can be adjusted by user adjustment.
- Q9 What does 50%FS (full scale) of user adjustment mean?
A Setting can be made within the range of 50% of the measurement range. Up to 200°C can be set if the measurement range is 0 to 400°C.
- Q10 MV is not output from Ao.
A Setting of OTYP (Ch8-9), which is output type selection, may have been set to 51, 52 or 53. Set OTYP to 50, 54 or 55.

8 SPECIFICATIONS

General specifications

General specifications

- (1) Power supply voltage:
100V (-15%) to 240V (+10%) AC, 50/60 Hz
- (2) Power consumption:
15 VA or less (100 V AC)
20 VA or less (220 V AC)
- (3) Insulation resistance:
20 MΩ or more (500 V DC)
- (4) Withstand voltage:
Power supply ↔ All terminals;
1500 V AC for 1 minute
Relay output ↔ All terminals;
1500 V AC for 1 minute
Others; 500 V AC for 1 minute

Input section

Measurement value input

- (1) Number of inputs: 1 or 2 (Option)
- (2) Input signal type:
Thermocouple: J, K, R, B, S, T, E, PR40/20, N, PL-II,
WRe5-26
Resistance bulb : Pt100Ω (3-wire)
Voltage: 0 to 10 mV DC, 0 to 50 mV DC,
1 to 5 V DC, 0 to 5 V DC, 0 to 10 V DC
Current: 4 to 20 mA DC, 0 to 20 mA DC
- (3) Measurement range:
Refer to the measurement range table.
- (4) Input indication accuracy (Ambient temperature: 23°C):
 - Thermocouple: ($\pm 0.1\%FS \pm 1\text{digit} \pm 1^\circ\text{C}$) or $\pm 1.5^\circ\text{C}$,
whichever is larger
Thermocouple B: 0 to 400°C range;
 $\pm 5\%FS \pm 1\text{digit} \pm 1^\circ\text{C}$
Thermocouple R: 0 to 500°C range;
 $\pm 1\%FS \pm 1\text{digit} \pm 1^\circ\text{C}$
 - Resistance bulb input: ($\pm 0.1\%FS \pm 1\text{digit}$) or $\pm 0.25^\circ\text{C}$,
whichever is larger
 - Voltage input, current input: $\pm 0.1\%FS \pm 1\text{digit}$
- (5) Input sampling cycle: 50 ms
- (6) Input impedance
 - Thermocouple, voltage input (mV): 1 MΩ or more
 - Voltage input (V): 1MΩ
 - Current input: 250Ω
- (7) Influence of source resistance / Permissible wiring resistance
 - Thermocouple, voltage input (mV): 0.1%FS per 100Ω
 - Voltage input (V): 0.1%FS per 500Ω
 - Resistance bulb input: 10Ω or less (per cable)
- (8) Permissible input voltage
 - Voltage (V) input: +35 V / -10 V DC
 - Current input: ± 25 mA DC
 - Thermocouple/Resistance bulb/Voltage (mV) input:
 ± 5 V DC
- (9) Noise reduction ratio
 - Normal mode: 40 dB (50/60 Hz) or more
 - Common mode: 120 dB (50/60 Hz) or more
- (10) Input value correction function (Input conditioner)
 - User adjustment:
 $\pm 50\%FS$ both for zero point and span point
 - Square-root extractor:
OFF or cut point from 0.0 to 125.0%
 - Input filter: 0.0 to 900.0 sec for time constant.

Auxiliary analog input (Option)

- (1) Number of inputs: 1
- (2) Input signal
DC voltage: 1 to 5 V DC / 0 to 5 V DC / 0 to 10 V DC
- (3) Input accuracy: $\pm 0.2\%FS$
- (4) Sampling cycle: 100 ms
- (5) Input impedance: 1 MΩ
- (6) Influence of source resistance: 0.2%FS per 500Ω
- (7) Permissible input voltage: +35 V / -10 V DC
- (8) Noise reduction ratio
 - Normal mode: 40 dB (50/60 Hz)
 - Common mode: 120 dB (50/60 Hz)
- (9) Input value correction function
 - User adjustment:
 $\pm 50\%FS$ both for zero point and span point
 - Square-root extractor:
OFF or cut point from 0.0 to 125.0%
 - Input filter: 0.0 to 900.0 sec for time constant.

Digital input (DI)

- (1) Number of points:
Basic: 4 (DI1-4)
Expansion: 5 (9 points in total at max.)
- (2) Specifications: Contact or transistor input
- (3) Contact capacity:
12 V DC, Approx. 2 mA (per point)
- (4) Detection pulse width: 200 ms or more
- (5) Function: Control mode changeover, EX-MV selection, SV
changeover, Control run/standby,
Auto-tuning start, Built-in timer start,
Alarm latch cancel.

Math function

- (1) Kind of formula:
Select by the parameter setting.
(flow compensation, Average, Hi/Lo selector, input
selector)
- (2) Operation parameter:
Analog input (PV1, PV2, Ai1),
Constant (K01 - K16)
- (3) Data type: Engineering unit (with floating point)

Output section

Control output

- (1) Number of points: 2
- (2) Type: Select one as follows.
 1. Relay contact output
 - Contact structure: OUT1 : SPDT contact (Do4 used)
OUT2 : SPST contact (Do3 used)
 - Contact capacity:
220V AC / 30 V DC, 3A (Resistive load)
220V AC / 30 V DC, 1A (Inductive load)
 - Life: 100,000 operations (rated load)
 2. SSR/SSC driver output (Voltage pulse)
 - Rating: 12 V DC (10 to 15 V DC)
 - Maximum current: 20mA (provided with protection
against short circuit)
 - Load resistance: 600Ω or more
 3. Current output (4 to 20 mA DC)
 - Accuracy: $\pm 0.2\%FS$
 - Linearity: $\pm 0.2\%FS$
 - Load resistance: 600Ω or less

8 SPECIFICATIONS

Digital output

- (1) Number of points:
 - Basic: 2 (Do3, 4)
 - Expansion: Maximum 7 (9 points in total at max.)
- (2) Specifications:
 - Contact structure:
 - SPST contact (except for Do4)
 - SPDT contact (Do4)
 - Contact capacity:
 - 220 V AC / 30 V DC, 1A (Resistive load)
 - Life: 100,000 operations (rated load)
- (3) Function: Alarm output, timer output, control output (Do3,Do4)

Analog re-transmission output

- (1) Number of points: 2 at max.
- (2) Type: Current output (4 to 20 mA DC)
 - Accuracy: $\pm 0.2\%$ FS
 - Linearity: $\pm 0.2\%$ FS
 - Load resistance: 600 Ω or less
- (3) Output contents: PV, SV, MV, DV

Transmitter power supply output

- (1) Number of points: 1 at max.
- (2) Rating:
 - 24 V DC (17 to 30 V DC), Maximum current; 23 mA (with short circuit protection)

Alarm function

Number of alarm points

- 8 points for setting

Type of alarm

- PV value (upper/lower limit, absolute/deviation, band), PV variation ratio, SV upper/lower limit, main unit error
<Optional operation>
 - Hold (standby) function
 - Alarm latching
 - Excitation/non-excitation
 - Operation delay: 0 to 9999 sec, 0 to 9999 min

Alarm output

- Allocated to DO1 to DO4 and DO11 to DO15 (Allocation change available.)

Communication function

PC Loader interface

- (1) Number of points: 1
- (2) Physical specifications: EIA RS232C
- (3) Protocol: Modbus-RTU
- (4) Communication method:
 - 3-wire, half-duplex, bit serial asynchro-nous communication
- (5) Data type, Data length:
 - 8 bits, Parity; Odd/Even/None
- (6) Communication speed:
 - 9600 bps, 19200 bps, 38400 bps
- (7) Connector: 3-pole, 2.5 mm dia. Sub-miniature jack
 - * Special cable is prepared as option.

RS-485 interface

- (1) Number of points: 1
- (2) Physical specifications: EIA RS485
- (3) Protocol: Modbus-RTU
- (4) Communication method:
 - 2-wire, half-duplex, bit serial asynchro-nous communication
- (5) Data type, Data length:
 - 8 bits, Parity; Odd/Even/None
- (6) Communication speed:
 - 9600 bps, 19200 bps, 38400 bps
- (7) Connection topology:
 - Multi-drop, Up to 31 units can be connected including master device
- (8) Communication distance:
 - 500 m max. (Total length of connection)

Display

- (1) Type: LED
- (2) Display contents
 - Measurement value display:
 - 7 segments, 5 digits (red),
 - Character height; 20 mm
 - Setting display: 7 segments, 5 digits (orange),
 - Character height; 13 mm
 - Auxiliary display:
 - 7 segments, 2 digits (orange),
 - Character height; 12 mm
 - Bar graph: 12 segments (orange)
 - Status display indicator lamp:
 - Standby, control mode (R/A/M), output, alarm

Operation and storage conditions

- (1) Ambient operating temperature: -10°C to 50°C
- (2) Storage temperature: -20°C to 60°C
- (3) Ambient humidity for use/storage:
 - 90% RH or less (non-condensing)
- (4) Warm-up time: 15 min or longer

Structure

- (1) Mounting method: Panel flush mounting
- (2) External terminal: M3 screw terminal
- (3) Case
 - Material: Plastic (Flame-resistant, UL94V-0)
 - Color: Gray
- (4) Protection
 - Faceplate: IEC IP66, NEMA-4X-equivalent (When mounted on panel with our genuine packing. Waterproof feature unavailable in side-by-side mounting.)
 - Body: IEC IP20 (Provided with slits on top and bottom faces)
 - Terminal section: IEC IP00. Terminal cover can be mounted (option).
- (5) External dimension:
 - 96 (W) x 96 (H) x 81.5 (D) mm
 - * "D" is the depth from the front face of the panel (not including terminal cover).
- (6) Mass: Approx. 500 g

Appendix 1 Terminal connection diagram

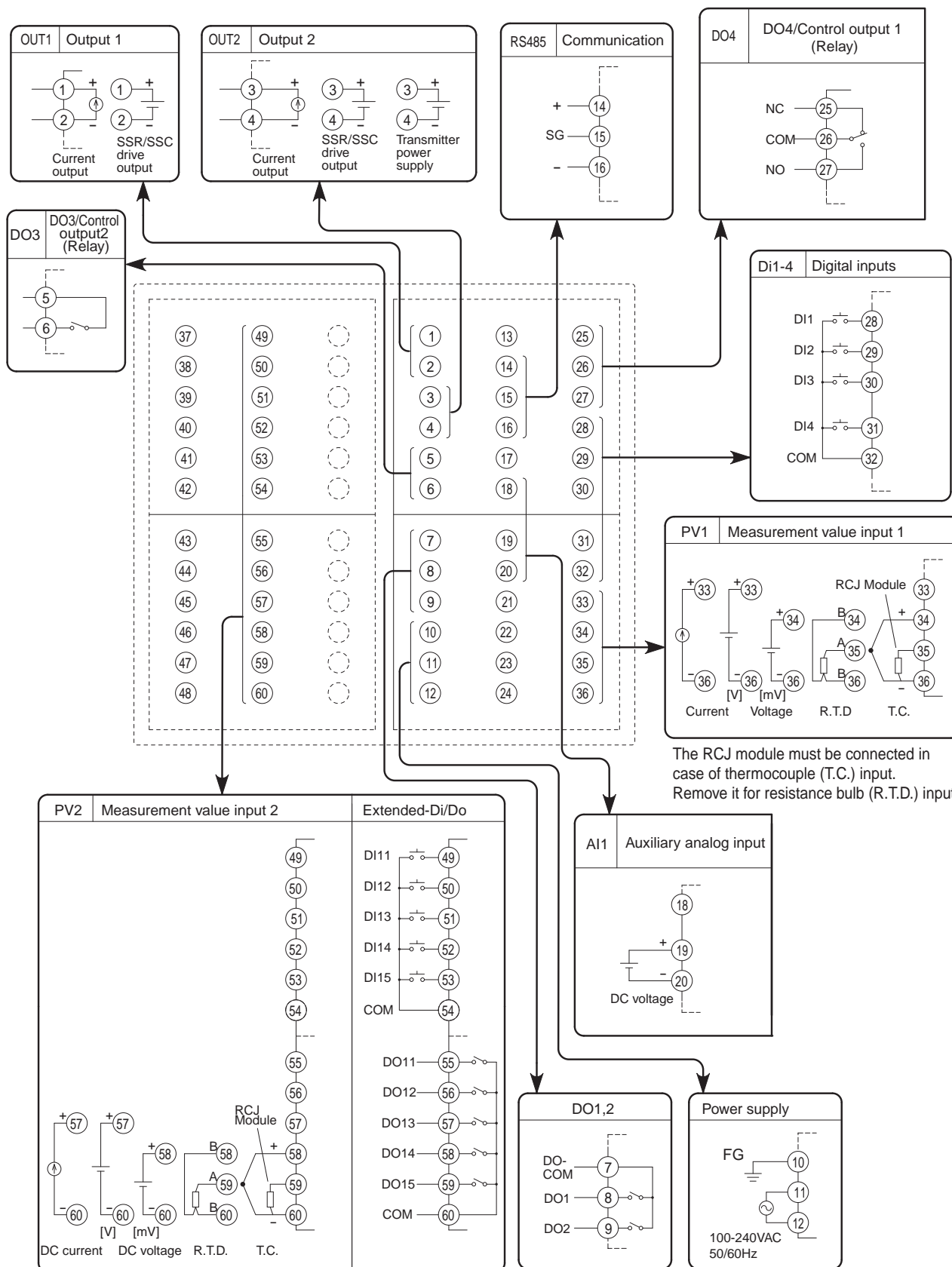

Appendix 2 Parameter list

| Ch1 <i>oPE</i> (Operation parameter) | | | | | | | | | | | | | | | | | | | | | | | | | | | | | | | | | | | | | | | | | | | | | | |
|--------------------------------------|---------------|--------|------------------------------|---|-----------------|----------------|--|---------------|--|-----------|-------|-----------|-------|---|---|---|---|---|---|---|---|---|---|---|---|---|---|---|---|---|---|---|---|---|---|---|---|---|---|---|---|---|---|---|-------|----------|
| No. | Parameter | | | Content Explanation | Factory default | Parameter mask | Notes | | | | | | | | | | | | | | | | | | | | | | | | | | | | | | | | | | | | | | | |
| | Display | Symbol | Name | | | | | | | | | | | | | | | | | | | | | | | | | | | | | | | | | | | | | | | | | | | |
| 1 | <i>rEN1</i> | rEM1 | Remote mode | Switches setting between remote/auto mode operation. REM: Remote mode AUT: Auto mode | AUT | 01-1 | See 4-3. | | | | | | | | | | | | | | | | | | | | | | | | | | | | | | | | | | | | | | | |
| 5 | <i>STBY</i> | STbY | Standby command | Switches controller to RUN/Standby. ON: Control standby (output OFF, alarm OFF) OFF: Control RUN | OFF | 01-5 | See 4-5. | | | | | | | | | | | | | | | | | | | | | | | | | | | | | | | | | | | | | | | |
| 6 | <i>PrG</i> | PrG | Ramp/soak activation command | Switches between ramp/soak operation states oFF : Stop rUn : Run hLd : Hold | OFF | 01-6 | See 5-29. | | | | | | | | | | | | | | | | | | | | | | | | | | | | | | | | | | | | | | | |
| 7 | <i>AT</i> | AT | Auto-tuning command | Sets auto-tuning. OFF: non-action ON1: start auto-tuning. | OFF | 01-7 | See 3-7. | | | | | | | | | | | | | | | | | | | | | | | | | | | | | | | | | | | | | | | |
| 8 | <i>LACH</i> | LACH | Alarm latch clear command | Disables alarm 1 - 8 latch. OFF: non-action CLR: Latch clear | OFF | 01-8 | See 3-8. | | | | | | | | | | | | | | | | | | | | | | | | | | | | | | | | | | | | | | | |
| 9 | <i>PLTn</i> | PLTn | Palette selection | Selects a PID palette to be used to control. (Setting range: 0 to 7) | 0 | 01-10 | See 5-6. | | | | | | | | | | | | | | | | | | | | | | | | | | | | | | | | | | | | | | | |
| 10 | <i>AL1</i> | AL1 | Alarm settings 1 | Alarm 1 operation value setting. Setting possible within the input range | 10%FS | 02-1 | Displayed when alarm operation type 1TP (chA-1) is set to 1 to 11. (See 3-8.) | | | | | | | | | | | | | | | | | | | | | | | | | | | | | | | | | | | | | | | |
| 11 | <i>A1-L</i> | A1-L | Alarm lower limit settings 1 | Alarm 1 lower limit operation value setting. Setting possible within the input range | 10%FS | 02-1 | Displayed when alarm operation type 1TP (chA-1) is set to 16 to 31. (See 3-8.) | | | | | | | | | | | | | | | | | | | | | | | | | | | | | | | | | | | | | | | |
| 12 | <i>A1-h</i> | A1-h | Alarm upper limit settings 1 | Alarm 1 upper limit operation value setting. Setting possible within the input range | 10%FS | 02-1 | Displayed when alarm operation type 1TP (chA-1) is set to 16 to 31. (See 3-8.) | | | | | | | | | | | | | | | | | | | | | | | | | | | | | | | | | | | | | | | |
| 31 | <i>AL8</i> | AL8 | Alarm settings 8 | Alarm 8 operation value setting. Setting possible within the input range | 10%FS | 02-8 | Displayed when alarm operation type 8TP (chA-36) is set to 1 to 11. (See 3-8.) | | | | | | | | | | | | | | | | | | | | | | | | | | | | | | | | | | | | | | | |
| 32 | <i>A8-L</i> | A8-L | Alarm lower limit settings 8 | Alarm 8 lower limit operation value setting. Setting possible within the input range | 10%FS | 02-8 | Displayed when alarm operation type 8TP (chA-36) is set to 16 to 31. (See 3-8.) | | | | | | | | | | | | | | | | | | | | | | | | | | | | | | | | | | | | | | | |
| 33 | <i>A8-h</i> | A8-h | Alarm upper limit settings 8 | Alarm 8 upper limit operation value setting. Setting possible within the input range | 10%FS | 02-8 | Displayed when alarm operation type 8TP (chA-36) is set to 16 to 31. (See 3-8.) | | | | | | | | | | | | | | | | | | | | | | | | | | | | | | | | | | | | | | | |
| 34 | <i>LoC</i> | LoC | Keylock | Selects parameter lock type (Setting range: 0 to 5) <table border="1" style="margin: 5px auto;"> <thead> <tr> <th rowspan="2">No.</th> <th colspan="2">Key operation</th> <th colspan="2">Communication</th> </tr> <tr> <th>All Parm.</th> <th>SV/MV</th> <th>All Parm.</th> <th>SV/MV</th> </tr> </thead> <tbody> <tr> <td>0</td> <td style="text-align: center;">○</td> <td style="text-align: center;">○</td> <td style="text-align: center;">○</td> <td style="text-align: center;">○</td> </tr> <tr> <td>1</td> <td style="text-align: center;">×</td> <td style="text-align: center;">×</td> <td style="text-align: center;">○</td> <td style="text-align: center;">○</td> </tr> <tr> <td>2</td> <td style="text-align: center;">×</td> <td style="text-align: center;">○</td> <td style="text-align: center;">○</td> <td style="text-align: center;">○</td> </tr> <tr> <td>3</td> <td style="text-align: center;">○</td> <td style="text-align: center;">○</td> <td style="text-align: center;">×</td> <td style="text-align: center;">×</td> </tr> <tr> <td>4</td> <td style="text-align: center;">×</td> <td style="text-align: center;">×</td> <td style="text-align: center;">×</td> <td style="text-align: center;">×</td> </tr> <tr> <td>5</td> <td style="text-align: center;">×</td> <td style="text-align: center;">○</td> <td style="text-align: center;">×</td> <td style="text-align: center;">×</td> </tr> </tbody> </table> <p style="text-align: center;">○: Can be set ×: Cannot be set</p> | No. | Key operation | | Communication | | All Parm. | SV/MV | All Parm. | SV/MV | 0 | ○ | ○ | ○ | ○ | 1 | × | × | ○ | ○ | 2 | × | ○ | ○ | ○ | 3 | ○ | ○ | × | × | 4 | × | × | × | × | 5 | × | ○ | × | × | 0 | 01-11 | See 5-7. |
| No. | Key operation | | Communication | | | | | | | | | | | | | | | | | | | | | | | | | | | | | | | | | | | | | | | | | | | |
| | All Parm. | SV/MV | All Parm. | SV/MV | | | | | | | | | | | | | | | | | | | | | | | | | | | | | | | | | | | | | | | | | | |
| 0 | ○ | ○ | ○ | ○ | | | | | | | | | | | | | | | | | | | | | | | | | | | | | | | | | | | | | | | | | | |
| 1 | × | × | ○ | ○ | | | | | | | | | | | | | | | | | | | | | | | | | | | | | | | | | | | | | | | | | | |
| 2 | × | ○ | ○ | ○ | | | | | | | | | | | | | | | | | | | | | | | | | | | | | | | | | | | | | | | | | | |
| 3 | ○ | ○ | × | × | | | | | | | | | | | | | | | | | | | | | | | | | | | | | | | | | | | | | | | | | | |
| 4 | × | × | × | × | | | | | | | | | | | | | | | | | | | | | | | | | | | | | | | | | | | | | | | | | | |
| 5 | × | ○ | × | × | | | | | | | | | | | | | | | | | | | | | | | | | | | | | | | | | | | | | | | | | | |
| 35 | <i>JP1</i> | JP1 | Parameter jump setting 1 | Press the function key (when 60 is selected), and the display jumps to the specified parameter. (Setting range: I-01 to Z-Z9) | 2-01 | 01-12 | See 5-13. | | | | | | | | | | | | | | | | | | | | | | | | | | | | | | | | | | | | | | | |
| 36 | <i>JP2</i> | JP2 | Parameter jump setting 2 | Press the function key (when 61 is selected), and the display jumps to the specified parameter. (Setting range: I-01 to Z-Z9) | 2-02 | 01-12 | | | | | | | | | | | | | | | | | | | | | | | | | | | | | | | | | | | | | | | | |
| 37 | <i>JP3</i> | JP3 | Parameter jump setting 3 | Press the function key (when 62 is selected), and the display jumps to the specified parameter. (Setting range: I-01 to Z-Z9) | 2-03 | 01-12 | | | | | | | | | | | | | | | | | | | | | | | | | | | | | | | | | | | | | | | | |

| Ch2 P_{Ld} (Control parameter) | | | | | | | |
|----------------------------------|---------|--------|--|---|--|----------------|---|
| Parameter | | | | Content Explanation | Factory default | Parameter mask | Notes |
| No. | Display | Symbol | Name | | | | |
| 1 | $P I$ | P1 | Proportional band on heating side | Setting range: 0.0 to 999.9% ON/OFF control at setting = 0. | 5.0 | 03-1 | See 5-3. |
| 2 | $I I$ | i1 | Integral time on heating side | Setting range: 0.0 to 3200.0 seconds Integral control OFF at setting = 0. | 240.0 | 03-1 | |
| 3 | $D I$ | d1 | Derivative time on heating side | Setting range: 0.0 to 999.9 seconds Derivative control OFF at setting = 0. | 60.0 | 03-1 | |
| 5 | $Arh I$ | Arh1 | Anti - reset windup Upper limit setting value | Integration cut point upper limit setting value (Setting range: 0 to 100%FS) | 100%FS | 03-3 | Sets by deviation from SV. (See 5-5.) |
| 6 | $ArL I$ | ArL1 | Anti - reset windup Lower limit setting value | Integration cut point lower limit setting value (Setting range: 0 to 100%FS) | 100%FS | 03-3 | |
| 7 | $Sh I$ | Sh1 | SV value upper limit | Sets upper limit SV (Setting range: -25 to 125%FS) | 100%FS | 03-4 | See 3-6. |
| 8 | $SL I$ | SL1 | SV value lower limit | Sets lower limit SV (Setting range: -25 to 125%FS) | 0%FS | 03-4 | |
| 9 | $Mvh I$ | Mvh1 | MV value upper limit | Sets upper limit MV (Setting range: -25.0 to 125.0%FS) | 105.0 | 03-5 | See 3-5, 5-2. |
| 10 | $MvL I$ | MvL1 | MV value lower limit | Sets lower limit MV (Setting range: -25.0 to 125.0%FS) | -5.0 | 03-5 | |
| 11 | $hh I$ | hh1 | MV upper limit value on heating side | Sets the upper limit value of operation output (MV) on heating side. (Setting range: -25 to 125%) | 100.0 | 40-8 | See 3-5. |
| 12 | $Lh I$ | Lh1 | MV lower limit value on heating side | Sets the lower limit value of operation output (MV) on heating side. (Setting range: -25 to 125%) | 0.0 | 40-8 | |
| 13 | $dMv I$ | dMv1 | MV change ratio limit | Sets the limit value of deviation of MV (DMV) in one control cycle (50ms.) (Setting range: 0.0 to 150.0%) 0.0: No limit | 0.0% | 03-7 | Limit is not applied to the deviation of MV by EX-MV operation. (See 5-2.) |
| 14 | $dT I$ | dT1 | Sampling cycle | Sets sampling cycle for PID operation. (Setting range: 5 to 1000) | 5 | 03-8 | The actual cycle is (dT1 × 10) ms. (See 5-3.) |
| 15 | $hS I$ | hS1 | Hysteresis setting | Hysteresis value during ON/OFF control time. (Setting range: 0 to 50%FS) | 0.3%FS | 03-9 | See 5-4. |
| 17 | $db I$ | db1 | Dead band | Sets the dead band and overlap band for heating/cooling control. (Setting range: -100.0 to 50.0%) | 0.0 | 03-11 | See 3-5. |
| 18 | $bAL I$ | bAL1 | Operation output convergence value | Sets output convergence value (Setting range: -100.0 to 100.0%) | 0.0% | 03-12 | See 5-5. |
| 19 | $TC I$ | TC1 | Cycle time of Control output (MV1) on heating side | Sets proportional cycle for control output. (Setting range: 1 to 150 sec) | By designation at the time of ordering | 03-13 | Effective only for RY output and SSR drive output. (See 3-5.) |
| 20 | $rEv I$ | rEv1 | Control action on heating side | Sets a control action NRML: Normal action REV: Reverse action | REV | 03-14 | See 3-5. |
| 22 | $PMv I$ | PMv1 | Preset value for control output on heating side | Sets MV for standby mode (Setting range: -25.0 to 125.0%) | 0.0 | 03-16 | See 4-5. |

| Ch2 P_{Ld} (Control parameter) | | | | | | | | | | | | | | | | | | | | | | | | |
|----------------------------------|------------------|------------|---|---|--------------------------|------------------|-----------|------------|------------|---|--------|--------|---|--------|-------|---|-------|--------|---|-------|-------|--|--|--|
| Parameter | | | | Content Explanation | Factory default | Parameter mask | Notes | | | | | | | | | | | | | | | | | |
| No. | Display | Symbol | Name | | | | | | | | | | | | | | | | | | | | | |
| 23 | $ALP1$ | ALP1 | Alpha | Sets 2 degrees of freedom coefficient α . (Setting range: -300.0 to 300.0%) | 40.0 | 40-1 | See 5-23. | | | | | | | | | | | | | | | | | |
| 24 | $bET1$ | bET1 | Beta | Sets 2 degrees of freedom coefficient β . (Setting range: 0.0 to 999.9%) | 100.0 | 40-1 | | | | | | | | | | | | | | | | | | |
| 25 | $PC1$ | PC1 | Proportional band on cooling side | Sets the proportional band (cooling side). (Setting range: 0.0 to 999.9%) | 5.0 | 40-3 | See 3-5. | | | | | | | | | | | | | | | | | |
| 26 | $iC1$ | iC1 | Integral time on cooling side | Sets the integral time (cooling side). (Setting range: 0.0 to 3200.0 sec) | 240.0 | 40-3 | | | | | | | | | | | | | | | | | | |
| 27 | $dC1$ | dC1 | Derivative time on cooling side | Sets the derivative time (cooling side). Derivative operation is set to OFF when setting=0. (Setting range: 0.0 to 999.9 sec) | 60.0 | 40-3 | | | | | | | | | | | | | | | | | | |
| 28 | $hC1$ | hC1 | MV upper limit value on cooling side | Sets the upper limit value of operation output (MV) (cooling side). (Setting range: -25.0 to 125.0%) | 100.0 | 03-6 | | | | | | | | | | | | | | | | | | |
| 29 | $lC1$ | LC1 | MV lower limit value on cooling side | Sets the lower limit value of operation output (MV) (cooling side). (Setting range: -25.0 to 125.0%) | 0.0 | 03-6 | | | | | | | | | | | | | | | | | | |
| 34 | $rCC1$ | TCC1 | Control output proportion cycle on cooling side | Sets the proportion cycle of control output (cooling side) (Setting range: 1 to 150 sec) | 30.0 (RY) 5.0 (SSR-d) | 40-4 | | | | | | | | | | | | | | | | | | |
| 35 | $rVC1$ | rVC1 | Control action on cooling side | Sets the control action of cooling side. NRML: Normal action REV: Reverse action | NRML | 40-5 | | | | | | | | | | | | | | | | | | |
| 37 | $PMC1$ | PMC1 | Control output volume on cooling side | Sets the output value at control standby (cooling side) (Setting range: -25.0 to 125.0%) | 0.0 | 40-7 | | | | | | | | | | | | | | | | | | |
| 38 | $Ld1$ | Ld1 | Output limiter type setting on heating side | Sets whether the output value should be limited or exceeded (125%, -25%) when the output reaches the output limit setting. (Setting range: 0 to 3) | 3 | 40-9 | | | | | | | | | | | | | | | | | | |
| 39 | $LdC1$ | LdC1 | Output limiter type setting on cooling side | | | 03-6 | | | | | | | | | | | | | | | | | | |
| | | | | <table border="1"> <thead> <tr> <th rowspan="2">Ld1 LdC1</th> <th colspan="2">Output operation</th> </tr> <tr> <th>Upper side</th> <th>Lower side</th> </tr> </thead> <tbody> <tr> <td>0</td> <td>125.0%</td> <td>-25.0%</td> </tr> <tr> <td>1</td> <td>125.0%</td> <td>Limit</td> </tr> <tr> <td>2</td> <td>Limit</td> <td>-25.0%</td> </tr> <tr> <td>3</td> <td>Limit</td> <td>Limit</td> </tr> </tbody> </table> | Ld1 LdC1 | Output operation | | Upper side | Lower side | 0 | 125.0% | -25.0% | 1 | 125.0% | Limit | 2 | Limit | -25.0% | 3 | Limit | Limit | | | |
| Ld1 LdC1 | Output operation | | | | | | | | | | | | | | | | | | | | | | | |
| | Upper side | Lower side | | | | | | | | | | | | | | | | | | | | | | |
| 0 | 125.0% | -25.0% | | | | | | | | | | | | | | | | | | | | | | |
| 1 | 125.0% | Limit | | | | | | | | | | | | | | | | | | | | | | |
| 2 | Limit | -25.0% | | | | | | | | | | | | | | | | | | | | | | |
| 3 | Limit | Limit | | | | | | | | | | | | | | | | | | | | | | |
| 97 | $EXM1$ | EXM1 | External control amount | Sets external output value. (Setting range: -25.0 to 125.0%) | 0.0 | 07-1 | See 5-22. | | | | | | | | | | | | | | | | | |
| 99 | $tF1$ | kF1 | FF gain | Sets Feed Forward gain and bias 1, bias 2. [FF = KF1 × (Input - B1F) + B2F] (Setting range: -1000.0 to 1000.0) | 0.0 | 40-2 | | | | | | | | | | | | | | | | | | |
| A0 | $b1F1$ | b1F1 | FF bias1 | | 0.0 | 40-2 | | | | | | | | | | | | | | | | | | |
| A1 | $b2F1$ | b2F1 | FF bias2 | | 0.0 | 40-2 | | | | | | | | | | | | | | | | | | |

| Ch4 <i>PLF</i> (Control palette) | | | | | | | |
|----------------------------------|-------------|--------|---|---|-----------------|----------------|----------|
| No. | Parameter | | | Content Explanation | Factory default | Parameter mask | Notes |
| | Display | Symbol | Name | | | | |
| 1 | <i>Sv1</i> | Sv1 | Setting value 1 | Palette 1 SV (Setting range: SV lower limit value to SV upper limit value) | 0%FS | 08-1 | See 5-6. |
| 2 | <i>P-1</i> | P-1 | Proportional band 1 on heating side | Palette 1 proportional band (Setting range: 0.0 to 999.9%) ON/OFF control at setting = 0. | 5.0 | 08-1 | |
| 3 | <i>i-1</i> | i-1 | Integral time 1 on heating side | Palette 1 integral time (Setting range: 0.0 to 3200.0 sec) Integral control OFF at setting = 0. | 240.0 | 08-1 | |
| 4 | <i>d-1</i> | d-1 | Derivative time 1 on heating side | Palette 1 derivative time (Setting range: 0.0 to 999.9 sec) Derivative control OFF at setting = 0. | 60.0 | 08-1 | |
| 6 | <i>Arh1</i> | Arh1 | Anti - reset windup upper limit value 1 | Palette 1 Anti - reset windup upper limit value setting. (Setting range: 0 to 100%FS) | 100%FS | 08-1 | |
| 7 | <i>ArL1</i> | ArL1 | Anti - reset windup lower limit value 1 | Palette 1 Anti - reset windup lower limit value setting. (Setting range: 0 to 100%FS) | 100%FS | 08-1 | |
| 10 | <i>Mh-1</i> | Mh-1 | MV upper limit value 1 | Palette 1 upper limit value of operation output (MV). (Setting range: -25.0 to 125.0%FS) | 105.0 | 08-1 | |
| 11 | <i>ML-1</i> | ML-1 | MV lower limit value 1 | Palette 1 lower limit value of operation output (MV). (Setting range: -25.0 to 125.0%FS) | -5.0 | 08-1 | |
| 12 | <i>hh-1</i> | hh-1 | MV upper limit value 1 on heating side | Palette 1 upper limit value on heating side of operation output (MV). (Setting range: -25.0 to 125.0%FS) | 100.0 | 08-1 | |
| 13 | <i>Lh-1</i> | Lh-1 | MV lower limit value 1 on heating side | Palette 1 lower limit value on heating side of operation output (MV). (Setting range: -25.0 to 125.0%FS) | 0.0 | 08-1 | |
| 16 | <i>hYS1</i> | hYS1 | Hysteresis 1 | Palette 1 hysteresis. (Setting range: 0 to 50%FS) | 0.3%FS | 08-1 | |
| 18 | <i>db-1</i> | db-1 | Dead band 1 | Palette 1 dead band and overlap band for heating/cooling control. (Setting range: -100.0 to 50%FS) | 0.0 | 08-1 | |
| 19 | <i>bL-1</i> | bL-1 | Output convergence value 1 | Palette 1 output convergence value. (Setting range: -100.0 to 100%) | 0.0 | 08-1 | |
| 26 | <i>PC-1</i> | PC-1 | Proportional band 1 on cooling side | Palette 1 proportional band on cooling side. (Setting range: 0.0 to 999.9%) Two-position operation is allowed when setting = 0. | 5.0 | 08-1 | |
| 27 | <i>iC-1</i> | IC-1 | Integral time 1 on cooling side | Palette 1 integral time on cooling side. (Setting range: 0.0 to 3200.0 sec) The integral operation is set to OFF when setting = 0. | 240.0 | 08-1 | |
| 28 | <i>dC-1</i> | dC-1 | Derivative time 1 on cooling side | Palette 1 derivative time on heating side. (Setting range: 0.0 to 999.9 sec) The derivative operation is set to OFF when setting = 0. | 60.0 | 08-1 | |
| 29 | <i>hC-1</i> | HC-1 | MV upper limit value 1 on cooling side | Palette 1 upper limit value on cooling side of operation output (MV). (Setting range: -25.0 to 125.0%FS) | 100.0 | 08-1 | |
| 30 | <i>LC-1</i> | LC-1 | MV lower limit value 1 on cooling side | Palette 1 lower limit value on cooling side of operation output (MV). (Setting range: -25.0 to 125.0%FS) | 0.0 | 08-1 | |
| } | | | | | | | |
| o1 | <i>Sv-7</i> | Sv7 | Setting value 7 | Palette 7 SV. (Setting range: SV lower limit value to SV upper limit value) | 0%FS | 14-1 | See 5-6. |
| o2 | <i>P-7</i> | P-7 | Proportional band 7 on heating side | Palette 7 proportional band on heating side. (Setting range: 0.0 to 999.9%) Two-position operation is allowed when setting = 0. | 5.0 | 14-1 | |

| Ch4 <i>PL7</i> (Control palette) | | | | | | | |
|----------------------------------|-------------|--------|---|---|-----------------|----------------|----------|
| Parameter | | | | Content Explanation | Factory default | Parameter mask | Notes |
| No. | Display | Symbol | Name | | | | |
| o3 | <i>i-7</i> | i-7 | Integral time 7 on heating side | Palette 7 integral time on heating side. (Setting range: 0.0 to 3200.0 sec.) The integral operation is set to OFF when setting = 0. | 240.0 | 14-1 | See 5-6. |
| o4 | <i>d-7</i> | d-7 | Derivative time 7 on heating side | Palette 7 derivative time on heating side. (Setting range: 0.0 to 999.9 sec.) Derivative operation is set to OFF when setting = 0. | 60.0 | 14-1 | |
| o6 | <i>Arh7</i> | Arh7 | Integration cut point upper limit value 7 | Palette 7 upper limit value of integration cut point. (Setting range: 0 to 100%FS) | 100%FS | 14-1 | |
| o7 | <i>ArL7</i> | ArL7 | Integration cut point lower limit value 7 | Palette 7 lower limit value of integration cut point. (Setting range: 0 to 100%FS) | 100%FS | 14-1 | |
| P0 | <i>Mh-7</i> | Mh-7 | MV upper limit value 7 | Palette 7 upper limit value of operation output (MV). (Setting range: -25.0 to 125.0%) | 105.0 | 14-1 | |
| P1 | <i>ML-7</i> | ML-7 | MV lower limit value 7 | Palette 7 lower limit value of operation output (MV). (Setting range: -25.0 to 125.0%) | -5.0 | 14-1 | |
| P2 | <i>hh-7</i> | hh-7 | MV upper limit value 7 on heating side | Palette 7 upper limit value on heating side of operation output (MV). (Setting range: -25.0 to 125.0%) | 100.0 | 14-1 | |
| P3 | <i>Lh-7</i> | Lh-7 | MV lower limit value 7 on heating side | Palette 7 lower limit value on heating side of operation output (MV). (Setting range: -25.0 to 125.0%) | 0.0 | 14-1 | |
| P6 | <i>hYS7</i> | hYS7 | Hysteresis 7 | Palette 7 hysteresis. (Setting range: 0 to 50%FS) | 0.3%FS | 14-1 | |
| P8 | <i>db-7</i> | db-7 | Dead band 7 | Palette 7 dead band and overlap band for heating/cooling control. (Setting range: -100.0 to 50%) | 0.0 | 14-1 | |
| P9 | <i>bl-7</i> | BL-7 | Output convergence value 7 | Palette 7 output convergence value. (Setting range: -100.0 to 100.0%) | 0.0% | 14-1 | |
| q6 | <i>PC-7</i> | PC-7 | Proportional band 7 on cooling side | Palette 7 proportional band on cooling side. (Setting range: 0.0 to 999.9%) Two-position operation is allowed when setting = 0. | 5.0 | 14-1 | |
| q7 | <i>IC-7</i> | IC-7 | Integral time 7 on cooling side | Palette 7 proportional band on cooling side. (Setting range: 0.0 to 3200.0 sec) Integral operation is set to OFF when setting = 0. | 240.0 | 14-1 | |
| q8 | <i>dC-7</i> | dC-7 | Derivative time 7 on cooling side | Palette 7 derivative time on cooling side. (Setting range: 0.0 to 999.9 sec.) Derivative operation is set to OFF when setting = 0. | 60.0 | 14-1 | |
| q9 | <i>hC-7</i> | HC-7 | MV upper limit value 7 on cooling side | Palette 7 upper limit value on cooling side of operation output (MV). (Setting range: -25.0 to 125.0%) | 100.0 | 14-1 | |
| r0 | <i>LC-7</i> | LC-7 | MV lower limit value 7 on cooling side | Palette 7 lower limit value on cooling side of operation output (MV). (Setting range: -25.0 to 125.0%) | 0.0 | 14-1 | |
| T1 | <i>rEF1</i> | rEF1 | PID switch point 1 | Palette 1 PID switch point (Setting range: -25 to 125%FS) | 0%FS | 08-1 | |
| T7 | <i>rEF7</i> | rEF7 | PID switch point 7 | Palette 7 PID switch point (Setting range: -25 to 125%FS) | 0%FS | 14-1 | See 5-6. |

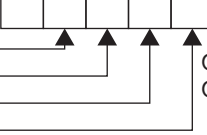
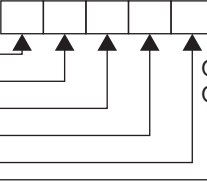
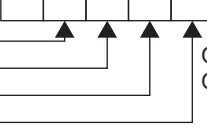
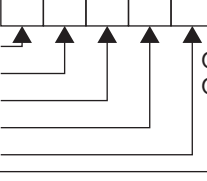
| Ch7 Non (Monitor) | | | | Content Explanation | Factory default | Parameter mask | Notes |
|-------------------|---------|--------|------------------------------------|--|-----------------|----------------|---------|
| Parameter | | | | | | | |
| No. | Display | Symbol | Name | | | | |
| 1 | PV1 | Pv1 | PV1 monitor | Displays Process value 1 input. | - | 17-1 | See 4-6 |
| 2 | PV2 | Pv2 | PV2 monitor | Displays Process value 2 input. | - | 17-2 | |
| 4 | AI1 | Ai1 | AI1 monitor | Displays Analog input 1 input. | - | 17-5 | |
| 6 | rSV1 | rSv1 | RSV1 monitor | Displays Remote set value 1. | - | 17-9 | |
| 10 | LSV1 | LSV1 | Local SV1 monitor | Display Local set value 1. | - | 17-9 | |
| 14 | rCJ1 | RCJ1 | RCJ1 monitor | Displays RCJ1 input. | - | 17-1 | |
| 15 | rCJ2 | RCJ2 | RCJ2 monitor | Displays RCJ2 input. | - | 17-2 | |
| 17 | Ao1 | Ao1 | AO1 monitor | Displays Analog output 1 output value. | - | 18-1 | |
| 18 | Ao2 | Ao2 | AO2 monitor | Displays Analog output 2 output value. | - | 18-1 | |
| 21 | dI01 | Di01 | DI monitor 1 | Displays DI1 to 4 status.  <p>OFF: Blank ON : Di No.</p> | - | 19-1 | |
| 22 | dI11 | Di11 | DI monitor 2 | Displays DI11 to 15 status.  <p>OFF: Blank ON : Di No.</p> | - | 19-1 | |
| 24 | do01 | DO01 | DO monitor 1 | Displays DO1 to 4 status.  <p>OFF: Blank ON : Do No.</p> | - | 19-1 | |
| 25 | do11 | DO11 | DO monitor 2 | Displays DO11 to 15 status.  <p>OFF: Blank ON : Do No.</p> | - | 19-1 | |
| 27 | AI | AiM | Math result monitor | Displays result of Math operation. | - | 19-3 | |
| 28 | TM1 | TM1 | Alarm delay remaining time monitor | Displays the remaining time for the alarm delay of ALM1 to ALM8. | - | 34-1 | |
| 29 | TM2 | TM2 | | | | 34-2 | |
| 30 | TM3 | TM3 | | | | 34-3 | |
| 31 | TM4 | TM4 | | | | 34-4 | |
| 32 | TM5 | TM5 | | | | 34-5 | |
| 33 | TM6 | TM6 | | | | 34-6 | |
| 34 | TM7 | TM7 | | | | 34-7 | |
| 35 | TM8 | TM8 | | | | 34-8 | |
| 36 | AMV1 | AMV1 | EXMV monitor | Displays the value to be output as EXMV. | - | 17-9 | |
| 40 | FFV1 | FFV1 | Feed Forward value | Displays the value of Feed Forward element. | - | 17-9 | |

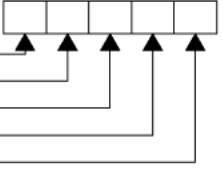
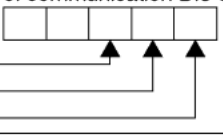
| Ch7 Non (Monitor) | | | | | | | |
|-------------------|---------|--------|---|---|-----------------|----------------|----------|
| Parameter | | | | Content Explanation | Factory default | Parameter mask | Notes |
| No. | Display | Symbol | Name | | | | |
| 44 | hMV1 | HMV1 | MV on heating side | MV monitor on heating side | - | 18-3 | |
| 48 | CMV1 | CMV1 | MV on cooling side | MV monitor on cooling side | - | 18-3 | |
| 100 | dCC1 | DiC1 | Communication Di monitor (1-5) | Displays the status of communication Di1-5.  | - | 19-4 | See 5-28 |
| 101 | dCC2 | DiC2 | Communication Di monitor (6-8) | Displays the status of communication Di6-8.  | - | 19-4 | |
| A2 | STAT | STAT | Display of Ramp/soak activation | Displays the Ramp/soak running status oFF : Ramp/soak is stopped 1-rP : Step1 during ramp 1-Sk : Step1 during soak ... 64rP : Step64 during ramp 64Sk : Step64 during soak End : Ramp/soak end | - | 15-1 | See 5-29 |
| A3 | rSTM | rSTM | Ramp/soak elapsed time | Displays the elapsed time of segment during Ramp/soak 00:00 to 99:59 (hour : min / min : sec) | - | 15-2 | |
| A4 | Pfno | PTno | Current pattern No. | Displays the pattern No. of the ramp soak currently selected. 0 to 30 | - | 15-3 | |
| A5 | bCPf | DiPT | Current pattern No. selected by DI | Displays the pattern No. of the ramp soak currently selected 0 to 30 | - | 15-4 | |
| A6 | rSV | rSV | Display the SV value which is result from Ramp/soak calculation | Displays the SV value which is result from Ramp/soak calculation. 0 to 100%FS | - | 15-5 | |

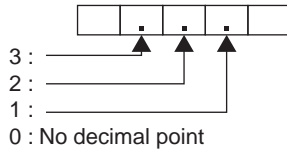
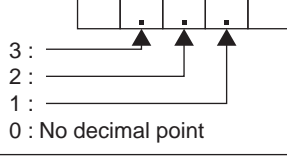
| Ch8 SET (Input/output definition) | | | | | | | |
|-----------------------------------|-------------------|--------|---------------------------------|---|-----------------|----------------|-----------|
| Parameter | | | | Content Explanation | Factory default | Parameter mask | Notes |
| No. | Display | Symbol | Name | | | | |
| 1 | P ₁ F | Pv1F | PV1 full-scale | Sets the full-side scale of PV1 input. (Setting range: -19999 to 99999) | As ordered | 20-1 | See 3-2. |
| 2 | P ₁ b | Pv1b | PV1 base scale | Sets the base-side scale of PV1 input. (Setting range: -19999 to 99999) | As ordered | 20-1 | |
| 3 | P ₁ d | Pv1d | PV1 decimal point position | Specifies the decimal point position of PV1 input. (Setting range: 0 to 3)  | 1 | 20-1 | |
| 4 | P ₁ T | Pv1T | PV1 input type | Sets the type of PV1 input. (Setting range: 0 to 27) | As ordered | 20-1 | See 5-9. |
| 5 | P ₁ U | Pv1U | PV1 unit | Sets the measurement unit. non : No unit °F : °F unit °C : °C unit | As ordered | 20-2 | |
| 6 | P ₁ Z | Pv1Z | PV1 input zero point adjustment | Sets the correction value of a zero point for PV1 input. (Setting range: -50 to 50%FS) | 0%FS | 20-3 | |
| 7 | P ₁ S | Pv1S | PV1 input span point adjustment | Sets the correction value of a span point for PV1 input. (Setting range: -50 to 50%FS) | 0%FS | 20-3 | See 5-1. |
| 11 | P ₁ CU | P1CU | PV1 input cut point | Sets the cut point of square-root extraction calculation for PV1 input. In case of OFF, the square-root extraction is not calculated. (Setting range: OFF, 0.0 to 125.0%) | OFF | 20-7 | |
| 12 | P ₁ FF | P1TF | PV1 input filter | Sets the time constant for PV1 input filter. (Setting range: 0.0 to 900.0 sec) | 0.0 | 20-8 | |
| 13 | P ₁ Ln | P1Ln | PV1 linearize setting | PV1 input linearize enable/disable setting (Setting range: OFF, nrML, hi-C, Lo-C) | OFF | 20-9 | See 5-27. |
| 14 | P ₂ F | Pv2F | PV2 full-scale | Sets the full-side scale of PV2 input. (Setting range: -19999 to 99999) | As ordered | 20-1 | See 3-2. |
| 15 | P ₂ b | Pv2b | PV2 base scale | Sets the base-side scale of PV2 input. (Setting range: -19999 to 99999) | As ordered | 20-1 | |
| 16 | P ₂ d | Pv2d | PV2 decimal point position | Specifies the decimal point position of PV2 input. (Setting range: 0 to 3)  | 1 | 20-1 | |
| 17 | P ₂ T | Pv2T | PV2 input type | Sets the type of PV2 input. (Setting range: 0 to 27) | 3 | 20-1 | See 5-9. |
| 18 | P ₂ U | Pv2U | PV2 unit | Sets the measurement unit for PV2 input. non : No unit °F : °F unit °C : °C unit | °C | 20-2 | |
| 19 | P ₂ Z | Pv2Z | PV2 input zero point adjustment | Sets the correction value of a zero point for PV2 input. (Setting range: -50 to 50%FS) | 0%FS | 20-3 | |
| 20 | P ₂ S | Pv2S | PV2 input span point adjustment | Sets the correction value of a span point for PV2 input. (Setting range: -50 to 50%FS) | 0%FS | 20-3 | See 5-1. |
| 24 | P ₂ CU | P2CU | PV2 input cut point | Sets the cut point of square-root extraction calculation for PV2 input. In case of OFF, the square-root extraction is not calculated. (Setting range: OFF, 0.0 to 125.0%) | OFF | 20-7 | |
| 25 | P ₂ FF | P2TF | PV2 input filter | Sets the time constant for PV2 input filter. (Setting range: 0.0 to 900.0 sec) | 0.0 | 20-8 | |

Note) Be sure to reset or turn on the power after parameter setting is changed.

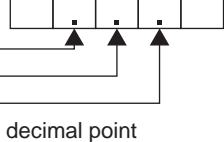
| Ch8 SET (Input/output definition) | | | | | | | |
|-----------------------------------|-------------|--------|---------------------------------|---|-----------------|----------------|-----------|
| Parameter | | | | Content Explanation | Factory default | Parameter mask | Notes |
| No. | Display | Symbol | Name | | | | |
| 26 | <i>P2Ln</i> | P2Ln | PV2 linearize setting | PV2 input linearize enable/disable setting (Setting range: OFF, nrML, hi-C, Lo-C) | OFF | 21-9 | See 5-27. |
| 40 | <i>ALIF</i> | Ai1F | Ai1 full scale | Sets the full-side scale of analog (Ai1) input. (Setting range: -19999 to 99999) | As ordered | 23-1 | See 3-2. |
| 41 | <i>ALib</i> | Ai1b | Ai1 base scale | Sets the scale of base-side analog (Ai1) input. (Setting range: -19999 to 99999) | As ordered | 23-1 | |
| 42 | <i>ALId</i> | Ai1d | Ai1 decimal point position | Specifies the decimal point position for analog (Ai1) input. (Setting range: 0 to 3)  <p>3 : ———▲——— 2 : ———▲——— 1 : ———▲——— 0 : No decimal point</p> | 1 | 23-1 | |
| 43 | <i>ALIT</i> | Ai1T | Ai1 input type | Sets the type of Ai1 input. (Setting range: 16 to 18, 23, 24) | 16 | 23-1 | |
| 45 | <i>ALIZ</i> | Ai1Z | Ai1 input zero point adjustment | Sets the correction value of a zero point for Ai1 input. (Setting range: -50 to 50%FS) | 0%FS | 23-3 | See 5-9. |
| 46 | <i>ALIS</i> | Ai1S | Ai1 input span point adjustment | Sets the correction value of a span point for Ai1 input. (Setting range: -50 to 50%FS) | 0%FS | 23-3 | |
| 49 | <i>ALCU</i> | A1CU | Ai1 input cut point | Sets the cut point of the square-root extraction calculation for Ai1 input. In case of OFF, the square-root extraction is not calculated. (Setting range: OFF, 0.0 to 125.0%) | OFF | 23-7 | See 5-1. |
| 50 | <i>ALFF</i> | A1TF | Ai1 input filter | Sets the time constant for Ai1 input filter. (Setting range: 0.0 to 900.0sec) | 0.0 | 23-8 | |
| 51 | <i>ALLn</i> | A1Ln | Ai1 linearize setting | Ai1 input linearize enable/disable setting (Setting range: OFF, nrML, hi-C, Lo-C) | OFF | 23-9 | See 5-27. |
| 64 | <i>AOIT</i> | Ao1T | AO1 output type | Switches the AO1 (re-transmission output) signal. Setting range: PV, SV, MV, DV, AiM, MVRB, TV | PV | 25-1 | See 3-9. |
| 66 | <i>AOIH</i> | Ao1h | AO1 output scale upper limit | Sets the scale upper limit value of the AO1 output. (Setting range: -130.0 to 130.0%) | 100.0% | 25-1 | |
| 67 | <i>AOIL</i> | Ao1L | AO1 output scale lower limit | Sets the scale lower limit value of the AO1 output. (Setting range: -130.0 to 130.0%) | 0.0% | 25-1 | |
| 68 | <i>AILH</i> | A1Lh | AO1 output limit upper limit | Sets the upper limit value of the AO1 output limit. (Setting range: -25.0 to 105.0%) | 105.0% | 25-1 | |
| 69 | <i>AILL</i> | A1LL | AO1 output limit lower limit | Sets the lower limit value of the AO1 output limit. (Setting range: -25.0 to 105.0%) | -5.0% | 25-1 | |
| 70 | <i>AO2T</i> | Ao2T | AO2 output type | Switches the AO2 (re-transmission output) signal. Setting range: PV, SV, MV, DV, AiM, MVRB, TV | PV | 25-2 | |
| 72 | <i>AO2H</i> | Ao2h | AO2 output scale upper limit | Sets the scale upper limit value of the AO2 output. (Setting range: -130.0 to 130.0%) | 100.0% | 25-2 | |
| 73 | <i>AO2L</i> | Ao2L | AO2 output scale lower limit | Sets the scale lower limit value of the AO2 output. (Setting range: -130.0 to 130.0%) | 0.0% | 25-2 | |
| 74 | <i>A2LH</i> | A2Lh | AO2 output limit upper limit | Sets the upper limit value of the AO2 output limit. (Setting range: -25.0 to 105.0%) | 105.0% | 25-2 | |
| 75 | <i>A2LL</i> | A2LL | AO2 output limit lower limit | Sets the lower limit value of the AO2 output limit. (Setting range: -25.0 to 105.0%) | -5.0% | 25-2 | |

Note) Be sure to reset or turn on the power after the parameter setting is changed.

| Ch8 <i>SET</i> (Input/output definition) | | | | | | | |
|--|-------------|--------|--------------------------------------|--|-----------------|----------------|-----------|
| Parameter | | | | Content Explanation | Factory default | Parameter mask | Notes |
| No. | Display | Symbol | Name | | | | |
| 88 | <i>CALC</i> | CALC | Calculation setting | Math function type setting (Setting range: 0 to 40) | 0 | 25-9 | See 5-14. |
| 89 | <i>UCF1</i> | UCF1 | Math function full scale | Sets the scale on the full side which is utilized for mathematical calculations. (Setting range: -19999 to 99999) | As ordered | 25-9 | |
| 90 | <i>UCb1</i> | UCb1 | Math function base scale | Sets the scale on the base side which is utilized for mathematical calculations. (Setting range: -19999 to 99999) | As ordered | 25-9 | |
| 91 | <i>UCd1</i> | UCd1 | Math function decimal point position | Sets the decimal point position for mathematical calculations. (Setting range: 0 to 3) | 1 | 25-9 | |
| 92 | <i>TPLT</i> | TPLT | Template | Specifies control template. The range of effective setting. 50 : Single-loop heating/cooling control (with math function) 51 : Single-loop SV selection heating/cooling control (with math function) 53 : Single-loop heating/cooling control 54 : Single-loop SV selection heating/cooling control | 53 | 25-10 | See 3-1. |
| 93 | <i>oTYP</i> | oTYP | Output type | Selects the control output selector type. (Setting range: 50 to 55) | As ordered | 25-11 | See 3-3. |
| 98 | <i>Cn01</i> | CN01 | System constant 1 | Sets a constant value used for templates. The meaning of the value varies depending on template. Make the setting after checking the description of each template. (Setting range: -19999 to 99999) | As ordered | 25-15 | |
| b3 | <i>Cn16</i> | CN16 | System constant 16 | | | | |

Note) Be sure to reset or turn on the power after the parameter setting is changed.

Ch9 545 (System definition)

| Parameter | | | | Content Explanation | Factory default | Parameter mask | Notes |
|-----------|-------------|--------|---|--|--|----------------|-----------|
| No. | Display | Symbol | Name | | | | |
| 1 | PAS1 | PAS1 | Password 1 | Sets security (passwords). (Setting range: 0000 to FFFF) | 0000 | 26-1 | See 5-20. |
| 2 | PAS2 | PAS2 | Password 2 | Sets security (password). (Setting range: 0000 to FFFF) | 0000 | 26-2 | |
| 3 | PAS3 | PAS3 | Password 3 | Sets security (password). (Setting range: 0000 to FFFF) | 0000 | 26-3 | |
| 7 | rCh1 | rih1 | Remote mode inhibiting | Prevents switching to the REMOTE mode. (Setting range: ON/OFF) | OFF | 27-1 | See 5-15. |
| 11 | rAC1 | rAC1 | R_ACK use selection | Selects use or non-use of R_ACK. (Setting range: INH, ENA) | INH | 27-5 | See 5-16. |
| 15 | A-M1 | A-M1 | A/M mode | Selects the A/M mode. (Setting range: A-M, A) | A-M | 27-9 | See 5-17. |
| 19 | Cnd1 | Cnd1 | Mode settings when the power turns ON. | Sets the mode when the power turns ON. (Setting range: A, R, M) | A | 28-1 | See 5-18. |
| 23 | Trk1 | Trk1 | Tracking method selection (SV) | Selects ON or OFF for tracking the local set value (SV) | ON | 28-9 | See 5-19. |
| 30 | STBo | STBo | Operation settings when in standby mode | Sets the front display operation in the standby mode. (Setting range: 0: lighting, 1: extinction) | 0 | 29-4 | See 4-5. |
| 31 | PLTS | PLTS | Palette switching method selection | Selects a palette switching factor. (Setting range: PLTn, SV, PV) | PLTn | 29-6 | See 5-6. |
| 32 | F1 | F1 | User designation key-1 (F1) | Sets user assignments for function keys. [F1] - [F3]. (Setting range: 0 to 72) | 0 | 29-7 | See 5-13. |
| 33 | F2 | F2 | User designation key-2 (F2) | | 0 | 29-8 | |
| 34 | F3 | F3 | User designation key-3 (F3) | | 0 | 29-9 | |
| 35 | brd1 | brd1 | Burnout direction specification (MV1) | Specifies the direction of the control output during a burnout. (Setting range: HOLD, LO, UP, EXMV) | Lo | 30-1 | See 5-8. |
| 39 | di01 | di01 | Assignment for digital input 1 | Sets assignments for DI1-DI14, DI11-DI15. (Setting range: 0 to 178) | di01 : 60 di02 : 70 di03 : 0 di04 : 103 | 31-1 | See 5-10. |
| 42 | di04 | di04 | Assignment for digital input 4 | | | | |
| 43 | di11 | di11 | Assignment for digital input 11 | | 0 | 31-2 | |
| 47 | di15 | di15 | Assignment for digital input 15 | | | | |
| 53 | do1 | do1 | Assignment for digital output 1 | Sets assignments for DO1-DO4, DO11-DO15. (Setting range: 0 to 427) | do1 : 1 do2 : 2 do3 : 3 do4 : 4 | 31-9 | See 5-11. |
| 56 | do4 | do4 | Assignment for digital output 4 | | | | |
| 57 | do11 | do11 | Assignment for digital output 11 | | 0 | 31-10 | |
| 61 | do15 | do15 | Assignment for digital output 15 | | | | |

Note) Be sure to reset or turn on the power after the parameter setting is changed.

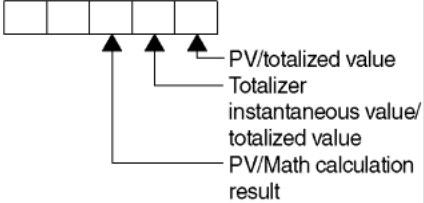
| Ch9 545 (System definition) | | | | | | | |
|-----------------------------|-------------|--------|---------------------------|---|------------------------|----------------|-----------|
| Parameter | | | | Content Explanation | Factory default | Parameter mask | Notes |
| No. | Display | Symbol | Name | | | | |
| 67 | <i>C1</i> | C1 | LED C1 assignment | Allocates indicator LEDs. (Setting range: 0 to 427) | 21 | 32-1 | See 5-12. |
| 68 | <i>C2</i> | C2 | LED C2 assignment | | 25 (Cooling output) | 32-2 | |
| 69 | <i>Ldo1</i> | Ldo1 | LED DO1 assignment | | Ldo1 : 1 | 32-3 | |
| 73 | <i>Ldo5</i> | Ldo5 | LED DO5 assignment | | Ldo2 : 2 | 32-4 | |
| | | | | | Ldo3 : 3 | 32-5 | |
| | | | | Ldo4 : 4 | 32-6 | | |
| | | | | Ldo5 : 0 | 32-7 | | |
| 74 | <i>LALM</i> | LALM | LED ALM assignment | | 17 | 32-8 | |
| 79 | <i>odSP</i> | odSP | Operation display setting | Sets display items during operation. (Setting range: 000 to 111)  | 000 | 32-15 | See 5-24. |
| 80 | <i>dS00</i> | dS00 | Parameter mask setting | Skips (not display) unnecessary parameters. | - | 0-1 | See 5-21. |
| C3 | <i>dS43</i> | dS43 | | | | 0-15 | |
| E3 | <i>rES</i> | rES | Reset command | Resets the main unit. ON : Reset OFF : Run | OFF | 33-1 | See 3-4. |

Note) Be sure to reset or turn on the power after parameter setting is changed.

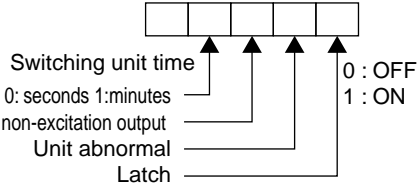
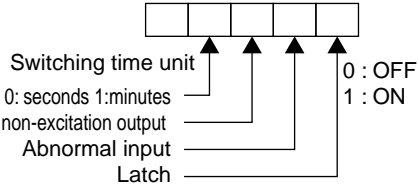
| ChA ALN (Alarm setting) | | | | | | | |
|-------------------------|-------------|--------|----------------------------|---|-----------------|----------------|----------|
| Parameter | | | | Content Explanation | Factory default | Parameter mask | Notes |
| No. | Display | Symbol | Name | | | | |
| 1 | <i>1rP</i> | 1TP | Alarm 1 type setting | Sets the alarm type for alarm 1. (Setting range: 0 to 38) | 0 | 34-1 | See 3-8. |
| 2 | <i>1oP</i> | 1oP | Alarm 1 option setting | Sets alarm options for alarm 1. (Setting range: 0000 to 1111)  | 0000 | 34-1 | |
| 3 | <i>1hYS</i> | 1hYS | Alarm 1 hysteresis setting | Sets alarm hysteresis for alarm 1. (Setting range: 0.00 to 50.00%FS) | 0.3%FS | 34-1 | |
| 4 | <i>1dLY</i> | 1dLY | Alarm 1 delay time setting | Sets delay time for alarm 1. (Setting range: 0 to 9999) * Sets alarm options for time units. The unit of time is selected by alarm options. | 0 | 34-1 | |
| } | | | | | | | |
| 36 | <i>8rP</i> | 8TP | Alarm 8 type setting | Sets the alarm type for alarm 8. (Setting range: 0 to 38) | 0 | 34-8 | See 3-8. |
| 37 | <i>8oP</i> | 8oP | Alarm 8 option setting | Sets alarm options for alarm 8. (Setting range: 0000 to 1111)  | 0000 | 34-8 | |
| 38 | <i>8hYS</i> | 8hYS | Alarm 8 hysteresis setting | Sets alarm hysteresis for alarm 8. (Setting range: 0.00 to 50.00%FS) | 0.3%FS | 34-8 | |
| 39 | <i>8dLY</i> | 8dLY | Alarm 8 delay time setting | Sets delay time for alarm 8. (Setting range: 0 to 9999) * Sets alarm options for time units. The unit of time is selected by alarm options. | 0 | 34-8 | |

| ChB Con (Communication) | | | | | | | | | | | | | | | | | | | |
|-------------------------|-------------|--------|------------------------------------|---|-----------------|----------------|-----------|--------|----|------|------|----|-----|-----|----|------|------|-------|------|
| Parameter | | | | Content Explanation | Factory default | Parameter mask | Notes | | | | | | | | | | | | |
| No. | Display | Symbol | Name | | | | | | | | | | | | | | | | |
| 2 | STn4 | STn4 | RS485 station No. | Specifies RS485 communication station No. (Setting range: 0 to 255) * does not operate with STn4=0. | 1 | 36-2 | See 3-10. | | | | | | | | | | | | |
| 3 | SPd4 | SPd4 | RS485 communication speed | Selects communication speed for RS485 communication. (Setting range) 96 : 9600 bps 192 : 19200 bps 384 : 38400 bps | 384 | 36-3 | | | | | | | | | | | | | |
| 4 | biT4 | biT4 | RS485 bit format | Selects bit format for RS485 communication. (Setting range) <table border="1" data-bbox="826 584 1070 707"> <thead> <tr> <th></th> <th>Data length</th> <th>Parity</th> </tr> </thead> <tbody> <tr> <td>8n</td> <td>8</td> <td>None</td> </tr> <tr> <td>8o</td> <td>8</td> <td>Odd</td> </tr> <tr> <td>8E</td> <td>8</td> <td>Even</td> </tr> </tbody> </table> | | Data length | | Parity | 8n | 8 | None | 8o | 8 | Odd | 8E | 8 | Even | 8o | 36-4 |
| | Data length | Parity | | | | | | | | | | | | | | | | | |
| 8n | 8 | None | | | | | | | | | | | | | | | | | |
| 8o | 8 | Odd | | | | | | | | | | | | | | | | | |
| 8E | 8 | Even | | | | | | | | | | | | | | | | | |
| 7 | SPd2 | SPd2 | PC Loader communication speed | Selects the communication speed for PC Loader communication. (Setting range) 96 : 9600 bps 192 : 19200 bps 384 : 38400 bps | 384 | 36-9 | | | | | | | | | | | | | |
| 8 | biT2 | biT2 | PC Loader bit format | Selects the bit format for PC Loader communication. (Setting range) <table border="1" data-bbox="826 891 1070 1014"> <thead> <tr> <th></th> <th>Data length</th> <th>Parity</th> </tr> </thead> <tbody> <tr> <td>8n</td> <td>8</td> <td>None</td> </tr> <tr> <td>8o</td> <td>8</td> <td>Odd</td> </tr> <tr> <td>8E</td> <td>8</td> <td>Even</td> </tr> </tbody> </table> | | Data length | Parity | 8n | 8 | None | 8o | 8 | Odd | 8E | 8 | Even | 8o | 36-10 | |
| | Data length | Parity | | | | | | | | | | | | | | | | | |
| 8n | 8 | None | | | | | | | | | | | | | | | | | |
| 8o | 8 | Odd | | | | | | | | | | | | | | | | | |
| 8E | 8 | Even | | | | | | | | | | | | | | | | | |
| 51 | CC01 | Ci01 | Communication Di1 function setting | Sets the function of communication Di1. | 0 | 36-16 | See 5-28. | | | | | | | | | | | | |
| 52 | CC02 | Ci02 | Communication Di2 function setting | Sets the function of communication Di2. | 0 | 36-16 | | | | | | | | | | | | | |
| 53 | CC03 | Ci03 | Communication Di3 function setting | Sets the function of communication Di3. | 0 | 36-16 | | | | | | | | | | | | | |
| 54 | CC04 | Ci04 | Communication Di4 function setting | Sets the function of communication Di4. | 0 | 36-16 | | | | | | | | | | | | | |
| 55 | CC05 | Ci05 | Communication Di5 function setting | Sets the function of communication Di5. | 0 | 36-16 | | | | | | | | | | | | | |
| 56 | CC06 | Ci06 | Communication Di6 function setting | Sets the function of communication Di6. | 0 | 36-16 | | | | | | | | | | | | | |
| 57 | CC07 | Ci07 | Communication Di7 function setting | Sets the function of communication Di7. | 0 | 36-16 | | | | | | | | | | | | | |
| 58 | CC08 | Ci08 | Communication Di8 function setting | Sets the function of communication Di8. | 0 | 36-16 | | | | | | | | | | | | | |

Note) Be sure to reset or turn on the power after parameter setting is changed.

| ChC L_{nr} (Linearize) | | | | | | | |
|--|---------|--------|----------------------|--|-----------------|----------------|-----------|
| Parameter | | | | Content Explanation | Factory default | Parameter mask | Notes |
| No. | Display | Symbol | Name | | | | |
| 1 | $P1X0$ | P1X0 | Linearize table P1X0 | Linearize table X0 for PV1 input (Setting range: -25% to 125%FS) | -25%FS | 37-1 | See 5-27. |
| } | | | | | | | |
| 32 | $P1YF$ | P1YF | Linearize table P1YF | Linearize table YF for PV1 input (Setting range: -25% to 125%FS) | 125%FS | 37-1 | |
| 33 | $P2X0$ | P2X0 | Linearize table P2X0 | Linearize table X0 for PV2 input (Setting range: -25% to 125%FS) | -25%FS | 37-2 | |
| } | | | | | | | |
| 64 | $P2YF$ | P2YF | Linearize table P2YF | Linearize table YF for PV2 input (Setting range: -25% to 125%FS) | 125%FS | 37-2 | |
| 97 | $A1X0$ | A1X0 | Linearize table A1X0 | Linearize table X0 for Ai1 input (Setting range: -25% to 125%FS) | -25%FS | 37-4 | |
| } | | | | | | | |
| 128 | $A1YF$ | A1YF | Linearize table A1YF | Linearize table YF for Ai1 input (Setting range: -25% to 125%FS) | 125%FS | 37-4 | |

| ChD LL (Calculation constant) | | | | | | | |
|---|---------|--------|----------------------------|--|-----------------|----------------|-----------|
| Parameter | | | | Content Explanation | Factory default | Parameter mask | Notes |
| No. | Display | Symbol | Name | | | | |
| 1 | $k01$ | k01 | Constant for Math function | Sets the constant used for mathematical expressions. | 0.0000 | 38-1 | See 5-14. |
| } | } | } | | | | 38-4 | |
| 16 | $k16$ | k16 | | | | | |

| ChE AT (Tuning) | | | | | | | |
|-------------------------------------|---------|--------|------------------|--|-----------------|----------------|----------|
| Parameter | | | | Content Explanation | Factory default | Parameter mask | Notes |
| No. | Display | Symbol | Name | | | | |
| 1 | $ATP1$ | ATP1 | Auto tuning type | Specifies the auto-tuning method. (Setting range) NRML : Standard type AT LPV : Low PV type AT | NRML | 39-1 | See 3-7. |

| ChG <i>r o f</i> (Totalizer) | | | | | | | |
|------------------------------|----------------|--------|----------------------------------|---|-----------------|----------------|-----------|
| Parameter | | | | Content Explanation | Factory default | Parameter mask | Notes |
| No. | Display | Symbol | Name | | | | |
| 1 | <i>r r Un</i> | TrUn | Totalizer command/status | Control the totalizer. (Setting range: HoLd/rUn/LATcH) | HOLD | 45-1 | See 5-25. |
| 2 | <i>r r ES</i> | TrES | Totalizer reset command | Resets totalizer. (on/oFF) | oFF | 45-1 | |
| 3 | <i>r o c n</i> | Toin | Totalizer input selection | Selects input used for totalizer. (Setting range: Pv1, Pv2, Ai1, AiM) * Math function scale (Ch8-89, 90, 91) is adopted when "(3) AiM" is selected. | Pv1 | 45-2 | |
| 4 | <i>r d P</i> | TdP | Totalizer decimal point position | Sets decimal point position of totalized value. (Setting range: 0 to 4) | 0 | 45-3 | |
| 5 | <i>r c U F</i> | TCUT | Totalizer input cut point | Sets the cut point for totalizer input. The input lower than the cut point is not added. (Setting range: 0% to 100%FS) | 0%FS | 45-4 | |
| 6 | <i>R 1 F P</i> | A1TP | Totalizer alarm 1 type | Sets alarm type of totalizer alarm 1. Setting range: 0: No alarm 1: Totalize value alarm 2: Batch control output 3: Batch control output (with auto reset) | 0 | 45-5 | |
| 7 | <i>R 1 o n</i> | A1on | Totalizer alarm 1 ON pulse width | Sets ON pulse width for batch control output for totalizer alarm 1. Setting range: 0: Continue 1: 100ms 2: 200ms 3: 500ms 4: 1 sec. | 0 | 45-5 | |
| 8 | <i>R 1 o P</i> | A1oP | Totalizer alarm 1 option setting | Sets excitation/non-excitation option for totalizer alarm 1 (Setting range: 0: Excitation, 1; Non-excitation) | 0 | 45-3 | |
| 9 | <i>R 2 F P</i> | A2TP | Totalizer alarm 2 type | Sets alarm type of totalizer alarm 2. Setting range: 0: No alarm 1: Totalize value alarm 2: Batch control output 3: Batch control output (with auto reset) | 0 | 45-6 | |
| 10 | <i>R 2 o n</i> | A2on | Totalizer alarm 2 ON pulse width | Sets ON pulse width for batch control output for totalizer alarm 2. Setting range: 0: Continue 1: 100ms 2: 200ms 3: 500ms 4: 1 sec. | 0 | 45-6 | |
| 11 | <i>R 2 o P</i> | A2oP | Totalizer alarm 2 option setting | Sets excitation/non-excitation option of totalizer alarm 2. (Setting range: 0; Excitation, 1; Non-excitation) | 0 | 45-6 | |
| 12 | <i>r n o d</i> | TMod | Operation mode | Selects operation mode from Japanese and English modes. [Japanese mode] Calculation is made using totalizer conversion factor. [English mode] Calculation is made based on time base time and scaling value. Setting range: (0) JPr: Japanese mode (1) EnG: English mode | EnG | 45-7 | |

| ChG Γ o Γ (Totalizer) | | | | | | | |
|-------------------------------------|----------------------|--------|------------------------------|--|-----------------|----------------|-----------|
| Parameter | | | | Content Explanation | Factory default | Parameter mask | Notes |
| No. | Display | Symbol | Name | | | | |
| 13 | Γ o Γ | ToPT | Totalizer option setting | (bit setting: 0000 to 1111) 0bit: Sets flickering of the totalized value at the occurrence of totalized value over. (Totalize is suspended while the display flickers.) 1bit: Totalizer operation at standby 0: Continue, 1: Stop 2bit: Command at power ON 0: Stop, 1: Start 3bit: Totalizer operation at the occurrence of erroneous input 0: Add, 1: Not add | 0011 | 45-8 | See 5-25. |
| 14 | Γ b | Tb | Totalizer time base | Sets reference unit time for totalize. (Setting range: SEC, Min, hour, dAY) | hoUr | 45-9 | |
| 15 | SCL | SCL | Totalizer scaling value | Divisor for totalizer input value scale conversion Note: Addition is not performed when 0 is selected. (Setting range: 0 to \pm 1000000) | 1 | 45-9 | |
| 16 | MUL | MUL | Input multiplier | Multiplier for input value scale conversion (Setting range 0 to \pm 1000000) | 1 | 45-9 | |
| 17 | Γ CF | TCF | Totalizer conversion factor | Totalized value display when 100% input is continued for 1 hour (Setting range: 20 to 9999999. The decimal point appears according to TdP setting.) | 10000 | 45-10 | |
| 18 | Γ in Γ | TinT | Totalizer initial value | The following relation holds when the value different from the current setting is selected as the initial value of totalizer. Totalized value = Initial value of totalizer (Setting range: 1999999 to 9999999. The decimal point appears according to TdP setting.) | 0 | 45-11 | |
| 19 | $A1SP$ | A1SP | Totalizer alarm 1 setting | Sets the operation value of totalizer alarm 1. (Setting range: 1999999 to 9999999. The decimal point appears according to TdP setting.) | 10000 | 45-5 | |
| 20 | $A2SP$ | A2SP | Totalizer alarm 2 setting | Sets the operation value of totalizer alarm 2. (Setting range: 1999999 to 9999999. The decimal point appears according to TdP setting.) | 10000 | 45-6 | |
| 21 | $rTSc$ | rTSc | Re-transmission output scale | Sets the totalized value that allows re-transmission output to be 100%. (Setting range:1999999 to 9999999. The decimal point appears according to TdP setting.) | 10000 | 45-12 | |

| ChH r5 (Ramp/soak) | | | | | | | |
|--------------------|-------------|--------|------------------------------------|---|--------------------|----------------|----------|
| Parameter | | | | Content Explanation | Factory default | Parameter mask | Notes |
| No. | Display | Symbol | Name | | | | |
| 1 | <i>Pfn</i> | PTn | Ramp/soak activation pattern | Sets up which step will be used for Ramp/soak. 0: 1-4 1: 5-8 2: 9-12 3: 13-16 4: 17-20 5: 21-24 6: 25-28 7: 29-32 8: 33-36 9: 37-40 10: 41-44 11: 45-48 12: 49-52 13: 53-46 14: 57-60 15: 61-64 16: 1-8 17: 9-16 18: 17-24 19: 25-32 20: 33-40 21: 41-48 22: 49-56 23: 57-64 24: 1-16 25: 17-32 26: 33-48 27: 49-64 28: 1-32 29: 33-64 30: 1-64 di: according to DI | 0 | 15-6 | See5-29. |
| 2 | <i>rTNU</i> | TiMU | Ramp/soak time units | Sets the units used when setting the ramp/soak time hh.MM (hour : min) MM.SS (min : sec) | hh.MM (0) | 15-7 | |
| 3 | <i>Sv-1</i> | Sv-1 | (STEP1) Ramp/soak SV setting value | Sets the SV 0 to 100%FS | 0%FS | 6-1 | |
| 4 | <i>rTr</i> | TM1r | (STEP1) Ramp time | Sets the ramp time 00:00 to 99:59 (hour : min / min : sec) | 00:00 (hour : min) | 16-1 | |
| 5 | <i>rTS</i> | TM1S | (STEP1) Soak time | Set the soak time 00:00 to 99:59 (hour : min / min : sec) | 00:00 (hour : min) | 16-1 | |
| | | | | | | 16-1 | |
| J2 | <i>Sv64</i> | Sv64 | (STEP64) SV setting value | Set the SV 0 to 100%FS | 0%FS | 16-1 | |
| J3 | <i>r64r</i> | T64r | (STEP64) Ramp time | Set the ramp time 00:00 to 99:59 (hour : min / min : sec) | 00:00 (hour : min) | 16-1 | |
| J4 | <i>r64S</i> | T64S | (STEP64) Soak time | Set the soak time 00:00 to 99:59 (hour : min / min : sec) | 00:00 (hour : min) | 16-1 | |
| J5 | <i>Mod</i> | Mod | Ramp/soak mode | Set the program operation method 0 to 15 | 0 | 15-8 | |
| J6 | <i>GSok</i> | GSok | Guaranty soak ON/OFF | Sets the guaranty soak ON/OFF oFF : Guaranty soak OFF on : Guaranty soak ON | oFF (0) | 15-9 | |
| J7 | <i>GS-h</i> | GS-h | Guaranty soak band (upper) | Sets the upper limit for the guaranty soak band. 0 to 50%FS | 1.25%FS | 15-9 | |
| J8 | <i>GS-L</i> | GS-L | Guaranty soak band (lower) | Sets the lower limit for the guaranty soak band 0 to 50%FS | 1.25%FS | 15-9 | |
| J9 | <i>PvST</i> | PvST | PV start | Sets whether or not to start ramp soak with PV oFF : P V start OFF on : P V start ON | oFF (0) | 15-10 | |
| K0 | <i>ConT</i> | ConT | Continue mode | Sets how to restart when the controller is restored after a power loss during ramp soak. rES : Reset (hold) Con : Continue ini : Restart | rES (0) | 15-11 | |
| K1 | <i>PfnM</i> | PTnM | Set the Max. pattern | Sets the selectable Max. number to select the pattern with the function key 0 to 30, di | 30 | 15-12 | |
| K2 | <i>Pfn</i> | Pmin | Set the Min. pattern | Sets the selectable Min. number to select the pattern with the function key 0 to 30, di | 0 | 15-12 | |

| ChX rCP (Recipe) | | | | | | | |
|------------------|-----------|--------|----------------------|---|-----------------|----------------|-----------|
| No. | Parameter | | | Content Explanation | Factory default | Parameter mask | Notes |
| | Display | Symbol | Name | | | | |
| 1 | rCP0 | rCP0 | Recipe allocation 1 | Sets parameter to be allocated as recipe 1 (Setting range 0-00 to W-Z9) | 0-00 | 46-1 | See 5-26. |
| } | | | | | | | |
| 10 | rCP9 | rCP9 | Recipe allocation 10 | Sets parameter to be allocated as recipe 10 (Setting range: 0-00 to W-Z9) | 0-00 | 46-10 | |
| 11 | d00 | d00 | Recipe setting 0 | Recipe parameter 1 setting for palette 0 (when palette is not used) (Setting range: According to rCP0 setting) | 0 | 46-15 | |
| } | | | | | | | |
| 20 | d09 | d09 | Recipe setting 9 | Recipe parameter 10 setting for palette 0 (when palette is not used) (Setting range: According to rCP9 setting) | 0 | 46-15 | |
| 21 | d10 | d10 | Recipe setting 10 | Recipe parameter 1 setting for palette 1 (Setting range: According to rCP0 setting) | 0 | 46-1 | |
| } | | | | | | | |
| 30 | d19 | d19 | Recipe setting 19 | Recipe parameter 10 setting for palette 1 (Setting range: According to rCP9 setting) | 0 | 46-10 | |
| 31 | d20 | d20 | Recipe setting 20 | Recipe parameter 1 setting for palette 2 (Setting range: According to rCP0 setting) | 0 | 46-1 | |
| } | | | | | | | |
| 40 | d29 | d29 | Recipe setting 29 | Recipe parameter 10 setting for palette 2 (Setting range: According to rCP9 setting) | 0 | 46-10 | |
| 41 | d30 | d30 | Recipe setting 30 | Recipe parameter 1 setting for palette 3 (Setting range: According to rCP0 setting) | 0 | 46-1 | |
| } | | | | | | | |
| 50 | d39 | d39 | Recipe setting 39 | Recipe parameter 10 setting for palette 3 (Setting range: According to rCP9 setting) | 0 | 46-10 | |
| 51 | d40 | d40 | Recipe setting 40 | Recipe parameter 1 setting for palette 4 (Setting range: According to rCP0 setting) | 0 | 46-1 | |
| } | | | | | | | |
| 60 | d49 | d49 | Recipe setting 49 | Recipe parameter 10 setting for palette 4 (Setting range: According to rCP9 setting) | 0 | 46-10 | |
| 61 | d50 | d50 | Recipe setting 50 | Recipe parameter 1 setting for palette 5 (Setting range: According to rCP0 setting) | 0 | 46-1 | |
| } | | | | | | | |
| 70 | d59 | d59 | Recipe setting 59 | Recipe parameter 10 setting for palette 5 (Setting range: According to rCP9 setting) | 0 | 46-10 | |
| 71 | d60 | d60 | Recipe setting 60 | Recipe parameter 1 setting for palette 6 (Setting range: According to rCP0 setting) | 0 | 46-1 | |
| } | | | | | | | |
| 80 | d69 | d69 | Recipe setting 69 | Recipe parameter 10 setting for palette 6 (Setting range: According to rCP9 setting) | 0 | 46-10 | |
| 81 | d70 | d70 | Recipe setting 70 | Recipe parameter 1 setting for palette 7 (Setting range: According to rCP0 setting) | 0 | 46-1 | |
| } | | | | | | | |
| 90 | d79 | d79 | Recipe setting 79 | Recipe parameter 10 setting for palette 7 (Setting range: According to rCP9 setting) | 0 | 46-10 | |

9 INDEX

| | | | |
|--|-----|---|----------|
| 2 | | L | |
| 2 degrees of freedom PID | 125 | LED allocation setting..... | 107 |
| A | | Limit value of MV change rate..... | 92 |
| Alarm delay time | 62 | Limit value of re-transmission output..... | 71 |
| Alarm hysteresis | 62 | Local SV | 86 |
| Alarm option | 60 | M | |
| Alarm setting..... | 64 | Manual operation..... | 82 |
| Alarm type..... | 58 | Manual operation prohibition setting..... | 119 |
| Alarm upper/lower limit setting | 64 | Math function..... | 114 |
| AT..... | 55 | Monitor | 89 |
| Auto operation | 80 | O | |
| Auto tuning function | 55 | Operation during standby | 87, 88 |
| Auto tuning method | 55 | Operation mode..... | 77 |
| B | | Output convergence value | 96 |
| Burnout direction | 99 | Output during standby | 88 |
| C | | Output type | 36 |
| Control operation type | 49 | P | |
| Control templates..... | 21 | Palette switching method setting | 97 |
| D | | Parameter jump | 109, 112 |
| Decimal point position of the input | 30 | Parameter mask | 123 |
| Derivative time..... | 93 | Password | 122 |
| Digital characters..... | 12 | PID | 93 |
| Digital input (Di) function | 101 | Proportion cycle | 51 |
| Digital output (Do) function..... | 105 | Proportional band | 93 |
| Direction at the input error burnout | 99 | R | |
| E | | Ramp/Soak | 145 |
| EX-MV function..... | 124 | Remote acknowledge (R-ACK) function..... | 118 |
| F | | Remote operation..... | 84 |
| Function key | 110 | Remote operation prohibition setting | 117 |
| H | | Remote SV..... | 84 |
| Hysteresis | 95 | Reset command | 38 |
| I | | Resetting alarm latch | 60 |
| Input decimal point position | 30 | Re-transmission | 68 |
| Input filter time constant..... | 90 | RS485 | 73 |
| Input rooter cut point..... | 90 | S | |
| Input scale | 28 | Scale of input | 28 |
| Input type | 32 | Scale of re-transmission output..... | 68 |
| Integral time..... | 93 | Screen display selection function..... | 126 |
| Integration upper/lower limit cut point..... | 96 | Set value (SV) | 53 |
| K | | Setting (SV)..... | 53 |
| Key lock function | 98 | Setting communications | 73 |
| | | Setting operation mode at the time of power ON..... | 120 |
| | | Standby function..... | 87 |
| | | SV limit value | 54 |
| | | SV tracking | 121 |
| | | SV upper/lower limit value..... | 54 |
| | | T | |
| | | Terminal connection diagram..... | 159 |
| | | Totalizer..... | 127 |

U

Unit of input..... 34
Upper/lower limit value of MV..... 92
User adjustment 100

Z

Zero/span adjustment value of input..... 100

Fuji Electric Co., Ltd.

International Sales Div

Sales Group

Gate City Ohsaki, East Tower, 11-2, Osaki 1-chome,
Shinagawa-ku, Tokyo 141-0032, Japan

<http://www.fujielectric.com>

Phone: 81-3-5435-7280, 7281 Fax: 81-3-5435-7425

<http://www.fujielectric.com/products/instruments/>
