

Digital Controller

[1-loop basic control type]

Type : PXH

User's Manual

BEFORE USE

Thank you very much for purchasing Fuji's digital controller (1-loop basic control type).

- (1) Be sure to deliver this manual to the end user.
- (2) Be sure to read this manual and grasp the concept before operating the instrument.
- (3) The purpose of this manual is to provide detailed information on the function of the instrument. It does not guarantee that the instrument conforms to the specific purpose of the customer.
- (4) No part or the whole of this manual may be reproduced without Fuji Electric permission.
- (5) The contents of this manual may be changed without prior notice.

Note

Sufficient care has been taken to assure the accuracy of this manual. Please note that Fuji Electric is not responsible for any damage, including indirect damage, resulting from an error in writing, missing information, or the use of the information described in the manual.



©Fuji Electric Co., Ltd. 2004

Issued in November, 2004
Rev. 1st edition January, 2006
Rev. 2nd edition May, 2008
Rev. 3rd edition April, 2011
Rev. 4th edition August, 2012

PLEASE READ FIRST

SAFETY WARNINGS

Please read the section “Safety Warnings” thoroughly before using. Please observe the warnings stated here as they contain important safety details. The safety warning items are divided into “WARNING” and “CAUTION” categories.

 WARNING	Mishandling may lead to death or serious injury.
 CAUTION	Mishandling may cause injury to the user or property damage.

⚠ WARNING

Limitations in use

This product was developed, designed and manufactured on the premise that it would be used for general machinery. In particular, if this product is to be used for applications that require the utmost safety as described below, please take into consideration the safety of the entire system and the machine by adopting such means as a fail-safe design, a redundancy design as well as the conducting of periodical inspections.

- Safety devices for the purpose of protecting the human body
- Direct control of transportation equipment
- Airplanes
- Space equipment
- Atomic equipment, etc,

Please do not use this product for applications which directly concern human lives.

Installation and wiring

- This equipment is intended to be used under the following conditions.

Ambient temperature	-10°C to 50°C	
Ambient humidity	90% RH or below (with no condensation)	
Installation category	II	by IEC1010-1
Pollution level	2	

- Between the temperature sensor and the location where the voltage reaches the values described below, secure clearance space and creepage distance as shown in the table below.

If such space cannot be secured, the EN61010 safety compliance may become invalid.

Voltage used or generated by any assemblies	Clearance Space [mm]	Creepage Space [mm]
Up to 50 Vrms or Vdc	0.2	1.2
Up to 100 Vrms or Vdc	0.2	1.4
Up to 150 Vrms or Vdc	0.5	1.6
Up to 300 Vrms or Vdc	1.5	3.0
Above 300 Vrms or Vdc	Please consult our distributor	

} hazardous voltage

- For the above, if voltage exceeds 50Vdc (called danger voltage), grounding and basic insulation for all terminals of the equipment and auxiliary insulation for warning outputs are required.

Note that the insulation class for this equipment is as follows. Before installing, please confirm that the insulation class for equipment meets usage requirements.

Power source	Internal Circuit
Digital output (Do) 1, 2	PC Loader Interface
	Measurement value input 1 (PV1)
Digital output (Do) 3	Measurement value input 2 (PV2)
Digital output (Do) 4	Auxiliary analog Input 1 (Ai1)
Digital output (Do) 11 to 15	Output 1 (Current / SSR driver)
	Output 2 (Current)
———— Basic insulation (1500VAC) Digital input (DI) 1 to 4
 Digital input (DI) 11 to 15
———— Functional insulation (500VAC)	Transmitter power supply
..... No insulation	RS485 / T-LINK

- In cases where damage or problems with this equipment may lead to serious accidents, install appropriate external protective circuits.
- As this equipment does not have a power switch or fuses, install them separately as necessary. (Main power switch: 2point Breaker, fuse rating: 250V 1A)
- For power supply wiring, use wire equal to 600V vinyl insulation or above.
- To prevent damage and failure of the equipment, provide the rated power voltage.
- To prevent shock and equipment failure, do not turn the power ON until all wiring is complete.
- Before feeding power, confirm that clearance space has been secured to prevent shock and fire with the equipment.

PLEASE READ FIRST

- Do not touch the terminal while the machine is on. Doing so risks shock or equipment errors.
- Never disassemble, convert, modify or repair this equipment. Doing so carries the risk of abnormal operation, shock and fire.

Maintenance

- When installing and removing the equipment, turn the power OFF. Failing to do so may cause shock operational errors or failures.
- Periodic maintenance is recommended for continuous and safe use of this equipment. Some components used on this equipment have a limited life and/or may deteriorate over time.
- The warranty period for this unit (including accessories) is one year, if the product is used properly.

Caution

Cautions when installing

Please avoid installing in the following locations.

- Locations in which the ambient temperature falls outside the range of -10 to 50°C when equipment is in use. (If the power supply is AC200V, the recommended maximum ambient temperature is 45°C .)
- Locations in which the ambient humidity falls outside the range of 0 to 90% RH when equipment is in use
- Locations with rapid temperature changes, leading to dew condensation
- Locations with corrosive gases (especially sulfide gas, ammonia, etc.) or flammable gases
- Locations in contact with water, oil, chemicals, steam or hot water (If the equipment gets wet, there is a risk of electric shock or fire, so have it inspected by the distributor.)
- Locations with high concentrations of atmospheric dust, salt or iron particles
- Locations with large inductive interference, resulting in static electricity, magnetic fields or noise
- Locations in direct sunlight.
- Locations that build up heat from radiant heat sources, etc.

Cautions when attaching the panels

- Please attach the PXH with the included Fixtures (2 pieces) to the top and bottom, and tighten with a screwdriver.

The clamp torque is approximately $0.15\text{ N}\cdot\text{m}$ ($1.5\text{ kg}\cdot\text{cm}$)

It is designed such that overtightening will cause left/right cracking to the central area of the Fixtures and hence reduce the torque.

Cracking to the central area will not cause any problems in terms of usability of the equipment as is.

(However, do exercise caution in not applying too much torque because the casing is made of plastic.)

Cautions for wire connections

- For thermocouple input, use the designated compensation lead; for resistance temperature sensors, use wires with small lead wire resistance and without any resistance difference among the three wires.
- To avoid noise conductor effects, do not use input signal wires in close proximity with electric power lines or load lines.
- Use input signal lines and output signal lines that are separated from each other and are shielded.
- If there is a lot of noise from the power source, adding an insulation transducer and using a noise filter is recommended.

(Example: TDK ZMB22R5-11 noise filter)

Always attach a noise filter to a panel that is grounded securely, and keep the wiring between the noise filter output side and the measuring equipment power terminal wiring to a minimum length. Please do not attach fuses and switches, etc. to the noise filter output wiring since doing so will decrease the filter's effectiveness.

- Twisting the measuring instrument wiring is effective when connecting the wires.
(The shorter the pitch of the twist, the more effective the connection is against noise.)
- Operation preparation time is required for the contact output when power is turned on. If using it as a signal to an external interlock circuit, please couple it with a delayed relay.
- Concerning the output relay, connecting the maximum rated load will shorten the product's life; so please attach an auxiliary relay. If the output operation frequency is high, selecting a SSR/SSC drive output type is recommended.

[Proportionate cycles] Relay output: 30 seconds or more,
SSR/SSC drive output: 1 second or more

- When inductive loads such as magnetic opening/closing equipment, etc. as relay output equipment are connected, use of "Zetrap," manufactured by Fuji Device Technology, Co. Ltd., is recommended in order to protect the connection points against opening/closing surges and to ensure long-term use.

Model names : ENC241D-05A (For 100V power voltage)
ENC471D-05A (For 200V power voltage)

Others

- Please do not wipe the equipment with organic solvents such as alcohol or benzene, etc. If wiping is necessary, do so with a neutral cleaning agent.
- Do not use mobile phones near the instrument (within 50 cm). Otherwise malfunction may occur.

CONTENTS

BEFORE USE	1
PLEASE READ FIRST	2
CONTENTS	6
1 OUTLINE	9
1-1 Code symbols	9
1-2 Checking the delivered items	10
1-3 Operating parts and their functions	11
1-4 Digital characters	12
2 INSTALLATION AND WIRING	13
2-1 Installation site	13
2-2 External and panel cut dimensions	14
2-3 Mounting the PXH to the panel	15
2-4 Before wiring	16
2-5 Wiring	17
3 BASIC USAGE	19
3-1 Setting control template	21
3-2 Setting input	29
3-3 Setting output type	38
3-4 Reset command	40
3-5 Setting control parameter	42
3-6 Setting the set value (SV)	46
3-7 AT (Auto tuning)	48
3-8 Alarm function	50
3-9 Re-transmission output	58
3-10 Setting communications	65
4 OPERATION	69
4-1 Auto operation	72
4-2 Manual operation	74
4-3 Remote operation (SV=Auxiliary input Ai1)	76
4-4 SV selection function (Remote operation)	78
4-5 Standby function	79
4-6 How to use monitoring function	81
5 ADVANCED USAGE	82
5-1 Setting inputs	82
5-2 Setting output	84
5-3 Setting PID	86
5-4 Setting hysteresis	87
5-5 Setting bAL, Arh, and ArL	88
5-6 Palette function	89
5-7 Key lock	90
5-8 Setting output direction at the input error burnout	91
5-9 User adjustment	92
5-10 Digital input (Di) function	93
5-11 Digital output (Do) function	97
5-12 Setting LED allocation	99
5-13 Function key	101
5-14 Math function	106
5-15 Remote operation prohibition	109
5-16 Remote acknowledge (R-ACK) function	110
5-17 Manual operation prohibition	111

5-18 Operation mode at the time of power ON	112
5-19 SV tracking function	113
5-20 Password	114
5-21 Parameter mask	115
5-22 EX-MV function	116
5-23 Setting 2 degrees of freedom PID	117
5-24 Screen display selection function	118
5-25 Totalizer function	119
5-26 Recipe function	130
5-27 Linearize function	133
5-28 Data change through communications	135
5-29 MV polarity reverse function	137
5-30 Ramp/Soak	138
6 TROUBLESHOOTING	146
7 FREQUENTLY ASKED QUESTIONS	149
8 SPECIFICATIONS	150
Appendix 1 Terminal connection diagram	152
Appendix 2 Parameter list	153
9 INDEX	172

1 OUTLINE

Thank you very much for purchasing Fuji's digital controller (1-loop basic control type). This manual describes the installation, operation, maintenance, etc. of this instrument. Read it carefully before operating the controller.

1-1 Code symbols

Before using the controller, check that the controller is of the type you ordered.

Digit	Description	Notes	1	2	3	4	5	6	7	8	9	10	11	12	13	← Digit	
			P	X	H	9	A			1	-	V			0		
4	<Dimension of front face H x W> 96 x 96 mm							9									
5	<Number of control loops/Function> 1-loop basic controller						A										
6	<Measurement value input> Universal input: 1 point Universal input: 2 points	*1						1	2								
7	<Auxiliary input> Not fitted DC voltage: 1 point							0	1								
8	<Version No.>								1								
9	<Output> OUT1 OUT2 ----- Current Not fitted Current Current Current Transmitter supply SSR/SSC driver Not fitted SSR/SSC driver Current											1	2	5	A	B	
10	<Power supply> 100 to 240 V AC												V				
11	<Communication interface> Not fitted RS-485													0	R		
12	<Digital input/output> Digital input Digital output (Including relay control output) ----- 4 points (Di1 to Di4) 2 points (Do3, Do4) 4 points (Di1 to Di4) 4 points (Do1 to Do4) 9 points (Di1 to Di4, Di11 to Di15) 9 points (Do1 to Do4, Do11 to Do15)	*1													0	A	B
13	<Additional specifications> Not fitted.															0	

*1 "2" in the 6th digit and "B" in the 12digit cannot be selected at the same time.

Terminal	Do4		OUT1		OUT2	
	Output Kind	Relay	Current (4 to 20 mA)	SSR/SSC driver	Current (4 to 20 mA)	Transmitter power supply
Function *	Control output or Digital output	Control output or Re-transmission output	Control output	Control output	Re-transmission output	Transmitter power supply
9th digit	1	○	○	—	—	—
	2	○	○	—	○	—
	5	○	○	—	—	○
	A	○	—	○	—	—
	B	○	—	○	○	—

— : Not fitted
○ : Fitted

* The selection of "Function" is specified according to the parameter.

1. OUTLINE

1-2 Checking the delivered items

Confirm that all of the following accessories are included.

- Digital Controller 1 unit
- Instruction Manual 1 copy
- CD-ROM 1 pc.

(Contents)

Instruction Manual

User's Manual

Communication Functions Instruction Manual (Modbus)

Communication Sample Program

Parameter Loader Instruction Manual

Parameter loader software

- Mounting fixture 2 pcs.
- Waterproof packing 1 pc.
- Unit nameplate 1 pc.
- Terminating resistance *1 1 pc.

*1) Supplied only when the communications function (RS485) is selected with this model.

Option

Name	Order No.
PC loader communication cable	ZZPPXH*TK4H4563
Terminal covers *2	ZZPPXR1-B230

*2) Two pieces are required per unit.

1-3 Operating parts and their functions

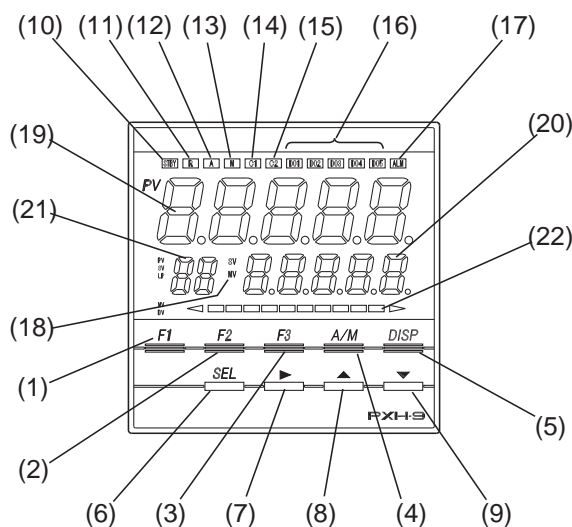

Operation Part

Name	Function
(1) F1 key	Assignable by the user.
(2) F2 key	Assignable by the user.
(3) F3 key	Assignable by the user.
(4) A/M key (AUTO/MANUAL switch key)	Switches between AUTO mode and MANUAL mode.
(5) DISP key (switch display key)	Switches display between the set value (SV) / control output (MV). Press the key to return from the setting mode to the operation mode (operation screen).
(6) SEL key (Select key)	For parameter block selection, parameter selection, and parameter setting change.
(7) ► key (Digit selection key)	Select a digit of data value for a desired setting change.
(8) ▲ key (Up key)	Increases the data value of a desired setting change. Changes the value of a set value (SV) when in operation. Used to select channels and parameters and change parameter settings in the setting mode.
(9) ▼ key (DOWN key)	Decreases the data value of a desired setting change. Changes the value of a set value (SV) when in operation. Used to select channels and parameters and change the parameter setting in the setting mode.

* For the current output, the lamp will not light.

Display

Name	Function
(10) STBY Lamp	Lamp lights when in standby mode.
(11) R Lamp	Lamp lights when in REMOTE mode.
(12) A Lamp	Lamp lights when in AUTO mode.
(13) M Lamp	Lamp lights when in MANUAL mode.
(14) C1 Lamp	Lamp lights when control output 1 is ON. *
(15) C2 Lamp	Lamp lights when control output 2 is ON. *
(16) DO1 Lamp DO2 Lamp DO3 Lamp DO4 Lamp DO5 Lamp	Lamp lights when digital output 1 to 4 (DO1 to DO4) is on. The lamp functions are assignable by the user.
(17) ALM Lamp	Lamp lights when alarm is activated.
(18) SV/MV Lamp	Indicates the status shown in the part of No.20 display. SV : Set value MV : Control output value
(19) Measurement value (PV) display	Displays the measurement value (PV) during operation. Also displays the parameter name when setting parameters.
(20) Set value (SV) display or control output value (MV) display	Displays the set values (SV) or control output value (MV) during operation. Displays lower 5 digits of the integrated value in integrated value display.
(21) Sub-segment display	During operation : When TPLT (ch8-92) is set at 10, 13 or 16 the loop number is displayed. When TPLT (ch8-92) is set at 11, 14, the SV number is displayed. Displays higher 2 digits of the integrated value in integrated value display. Setting parameters : Parameter number is displayed.
(22) Bar graph display	Displays a bar graph of control output (MV) during operation.

1. OUTLINE

1-4 Digital characters

The following tables provide correspondence between digital characters used for the display of the controller and alphanumerical characters.

Alphabet	Digital character	Alphabet	Digital character	Alphabet	Digital character
A	<i>A</i>	K	<i>k</i>	U	<i>U</i>
B	<i>b</i>	L	<i>L</i>	V	<i>v</i>
C	<i>C</i>	M	<i>M</i>	W	<i>W</i>
D	<i>d</i>	N	<i>n</i>	X	<i>X</i>
E	<i>E</i>	O	<i>o</i>	Y	<i>Y</i>
F	<i>F</i>	P	<i>P</i>	Z	<i>Z</i>
G	<i>G</i>	Q	※		
H	<i>h</i>	R	<i>r</i>		
I	<i>i</i>	S	<i>S</i>		
J	<i>J</i>	T	<i>T</i>		

Numeric character	Digital character	Numeric character	Digital character
1	<i>1</i>	6	<i>6</i>
2	<i>2</i>	7	<i>7</i>
3	<i>3</i>	8	<i>8</i>
4	<i>4</i>	9	<i>9</i>
5	<i>5</i>	0	<i>0</i>

* Not used by PXH.

2 INSTALLATION AND WIRING

2-1 Installation site

Install the controller in the following places.

- A place where ambient temperature falls within the range from -10 to 50°C , and temperature change is minimal (We recommend you to use the controller at the ambient temperature of 45°C at the maximum if the power supply is 200V AC.).
- A place where ambient humidity falls within the range from 0 to 90%RH, and where condensation does not occur.
- A place where corrosive gases (such as sulfuric gas or ammonia) or inflammable gases are not generated.
- A place where vibration or impact is not directly transferred to the main unit (The output relay may malfunction because of vibration or impact.).
- A place not subjected to exposure to water, oil, chemicals, vapor, and steam (If water is splashed onto the controller, electrical leaks or fire may occur. Ask your distributor for maintenance in such cases.).
- A place where accumulation of heat due to radiant heat does not occur.
- A place where electromagnetic interference by radios or mobile phones does not occur.
- A place where dust, salt, or iron content is minimal.
- A place not subjected to direct sunlight.
- A place where inductive interference is large and therefore not prone to generation of static electricity, magnetism, and noise.

2-2 External and panel cut dimensions

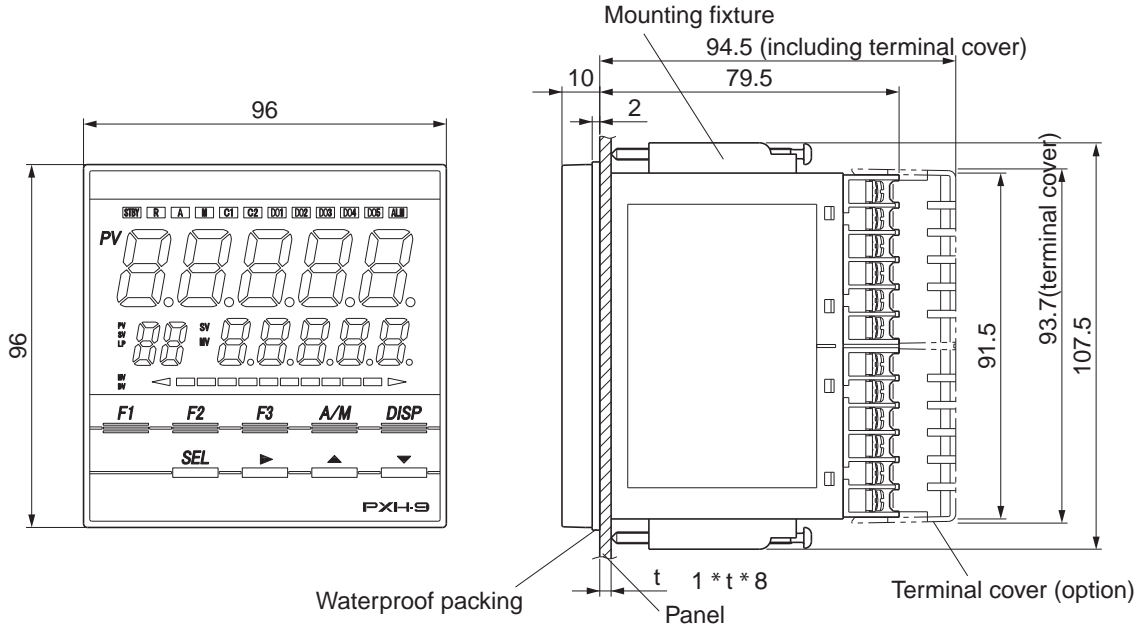

PC loader interface

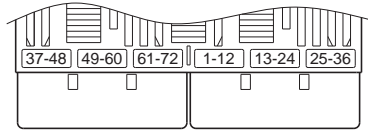
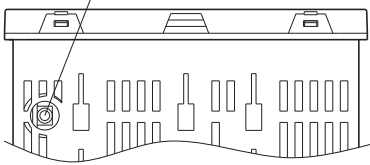

Panel Cutout Dimensions

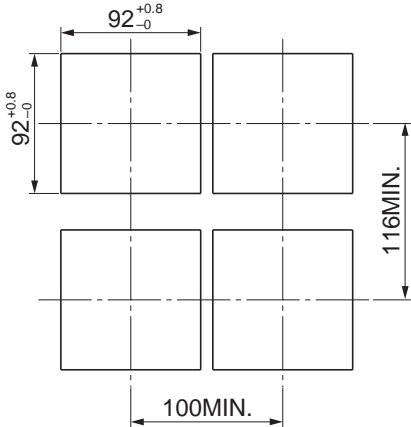

Note: In the case where a paint finish will be applied after panel hole-punching, take care of the finished dimensions.

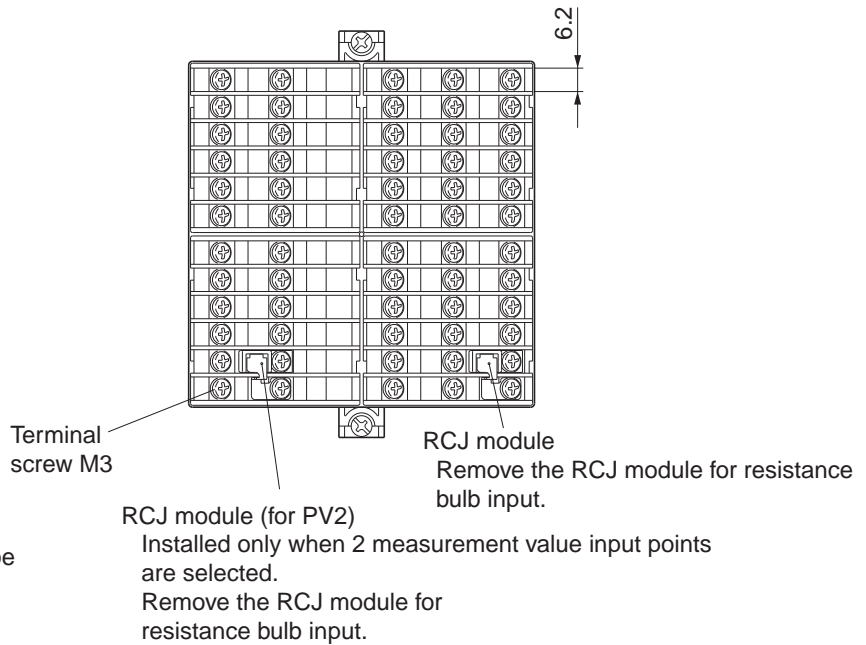

2-3 Mounting the PXH to the panel

- Please attach the PXH with the included Fixtures (2 pieces) to the top and bottom, and tighten with a screwdriver.
The clamp torque is approximately 0.15 N·m (1.5 kg·cm)
(However, do exercise caution in not applying too much torque because the casing is made of plastic.)
- The front of this equipment is waterproof in compliance with NEMA-4X standards (IP66-equivalent). However, regarding waterproofing between the equipment and the panel, use the included packing to ensure waterproofing and attach it according to the guidelines below. (Incorrect attachment may cause the equipment to lose its waterproof capabilities.)
 - (1) As shown in Fig. 1, insert the panel after attaching the packing to the equipment case.
 - (2) As shown in Fig. 2, tighten the fixture screws so that no gaps can remain between the equipment face, the packing and the panels. Once finished, confirm that there are no changes in shape such as displaced or improperly-fitted packing, etc. as shown in Fig. 3.
- Please exercise caution if the panel strength is weak and gaps develop between the packing and the panel, as this will result in the loss of its waterproofing capabilities.

Mounting Method

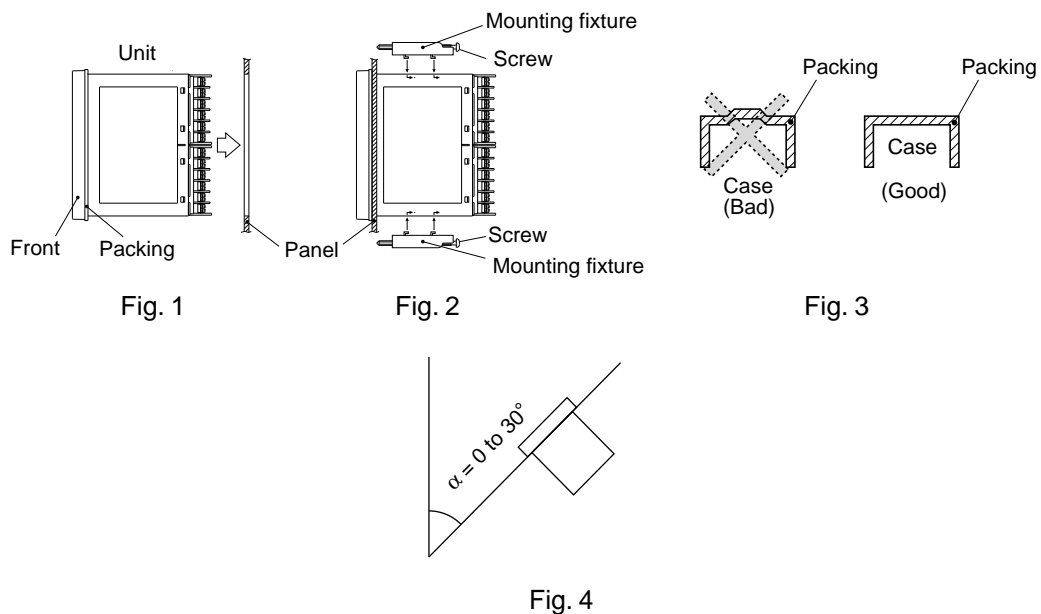

Standard: vertical panel attachment (horizontal position installing)
If attached at an angle, the maximum gradient is a 30° downslope.

(Caution)

- In order not to hamper heat radiation, do not block the sides of the equipment.
- Do not block the air vents on the upper part of the terminal.
- For the PXH9, please attach the Fixtures to the attachment holes in the center of the main unit.

2-4 Before wiring

- Use wires and Crimp-style terminals of the size shown below for connection.

Wire size

Parts	Size
Thermocouple (Compensation wire)	1.25mm ² or smaller
Wire	1.25mm ² or smaller

Crimp-style terminal

Applicable wire size	Fastening torque
0.25 to 1.25mm ²	0.8N·m

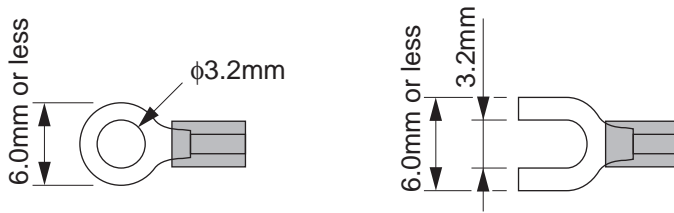

2-5 Wiring

- For thermocouple input use the appropriate compensating cable, for resistance bulb sensors, use wires with small resistance and without any resistance difference among the three wires.
- To avoid noise conductor effects, do not use input signal wires in close proximity with electric power lines or load lines.
- Use input signal lines and output signal lines that are separated from each other and are shielded.
- If there is a lot of noise from the power source, adding an insulation transducer and using a noise filter is recommended.

(Example: TDK ZMB22R5-11 noise filter)

Always attach a noise filter to a panel that is grounded securely, and keep the wiring between the noise filter output side and the measuring equipment power terminal wiring to a minimum length. Please do not attach fuses and switches, etc. to the noise filter output wiring since doing so will decrease the filter's effectiveness.

- Twisting the measuring instrument wiring is effective when connecting the wires.
(The shorter the pitch of the twist, the more effective the connection is against noise.)
- It takes preparation time before operation starts for the contact output when power is turned on. If using it as a signal to an external interlock circuit, please couple it with a delayed relay.
- Concerning the output relay, connecting the maximum rated load will shorten the relay's life; so please attach an auxiliary relay. If the output operation frequency is high, selecting a SSR/SSC drive output type is recommended.

[Proportional cycles] Relay output: 30 seconds or more,
SSR/SSC drive output: 1 second or more

- When inductive loads such as magnetic opening/closing equipment, etc. as relay output equipment are connected, use of "Zetrap," manufactured by Fuji Device Technology, Co. Ltd., is recommended in order to protect the connection points against opening/closing surges and to ensure long-term use.

Model names : ENC241D-05A (For 100V power voltage)

ENC471D-05A (For 200V power voltage)

Attachment position : Please connect between the relay control output connection points. (Refer to Fig. 5.)

- If using a thermocouple input, make sure that an RCJ module is connected as shown in the Fig. 5. (If an RCJ module is not connected, the temperature measurement cannot function.)
To use resistance bulb input instead of thermocouple input, remove RCJ module.
Keep the removed RCJ module, and do not forget to mount it back again when input is changed.
- Take wiring resistance into consideration when using a Zener barrier.
- In applying mV voltage, do not remove the RCJ module.
- It is dangerous to make an SSR connection when the output is set at 4-20mA, because the output will be kept "ON" even when the MV display shows -5%. Make sure to confirm the setting and the wiring before making the SSR connection.
- When the transmitter power supply model is selected, the external wiring will be connected as Fig. 6.

2 INSTALLATION AND WIRING

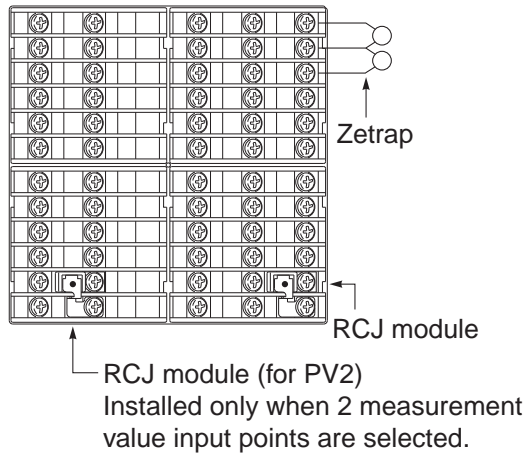
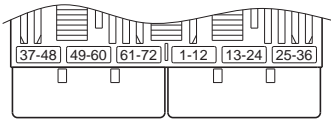

Fig. 5 Attachment position of Zetrap and RCJ module

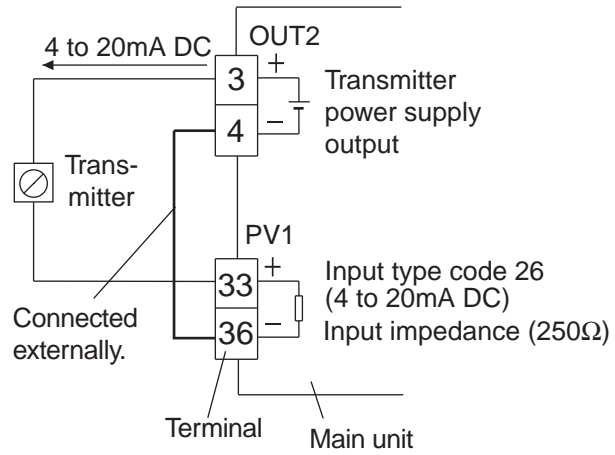
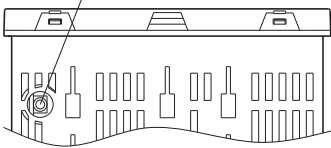

Fig. 6 External wiring for the model with the transmitter power supply

PC loader interface



- To connect the main unit to a PC, connect the optional PC loader communication cable to the PC loader interface and the serial port (RS232C) of the PC.

- Connection when terminal cover is used
To connect 2 cables to one terminal, use cables of 1.25 mm² or smaller in diameter, and make connections as shown by the figure at right.

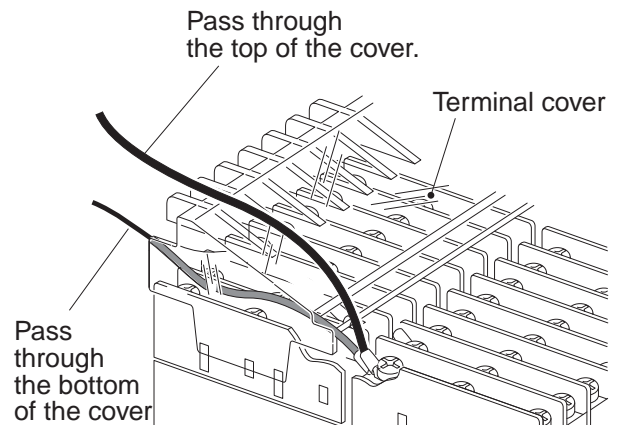

3 BASIC USAGE

Basic settings required in the flow from power ON to the start of operation are shown below. See the next page for basic key operations.

Setting procedure

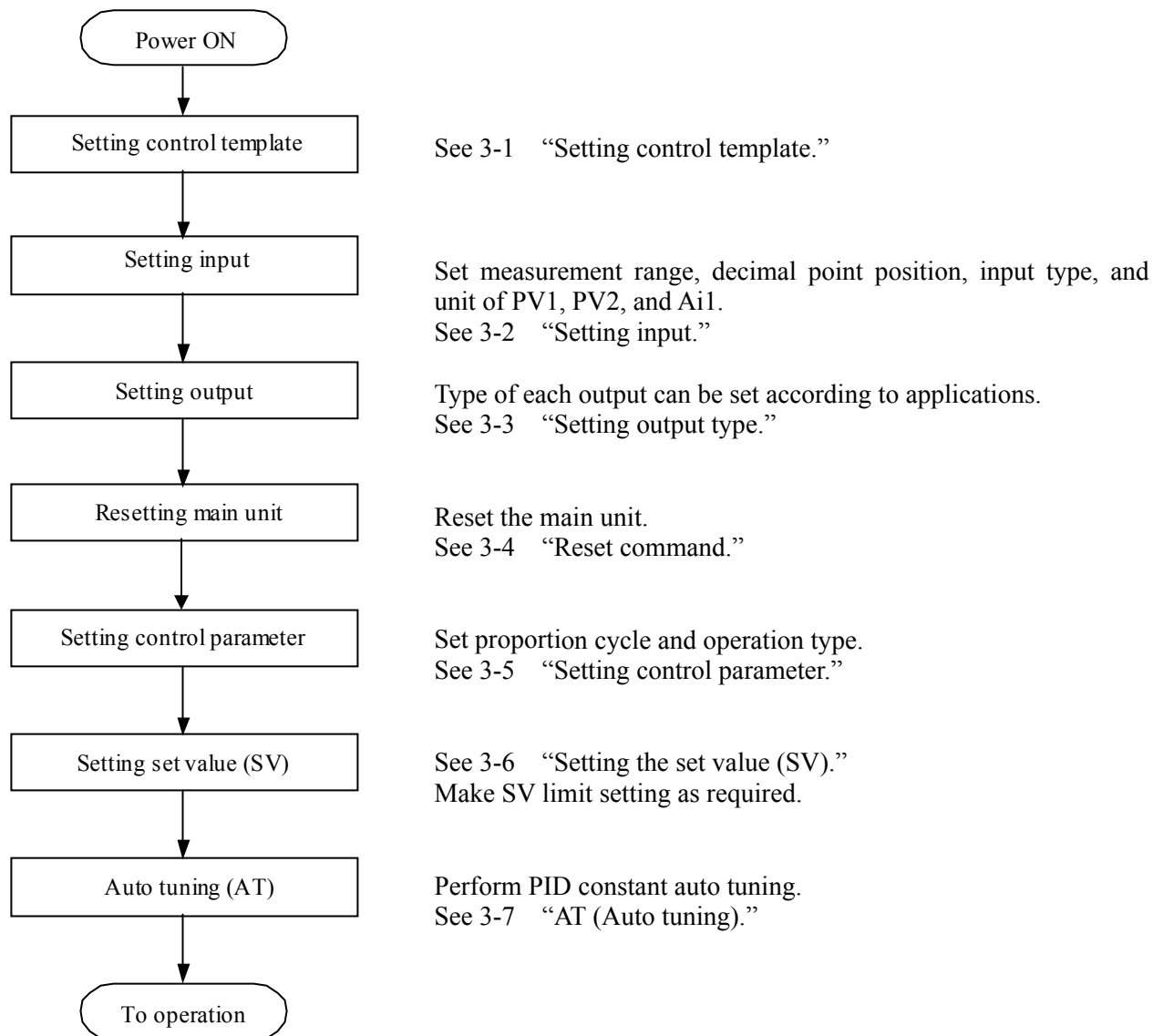

[Note]

- * To enable the setting of [rEv1] of Ch2, Ch9, ChB, and Ch8 that has been registered, reset the controller or turn on the power again.
- * If key operation is not performed for 10 seconds under the condition where the setting is flickering in setting change mode, the value being changed is canceled.
- * This instrument is not provided with the function of automatically returning to the operation screen when no operation status is continued. Return to the operation screen manually.
- * Parameters in the text are expressed as shown below.

Example: STbo (Ch1 - 5)



Switching parameters

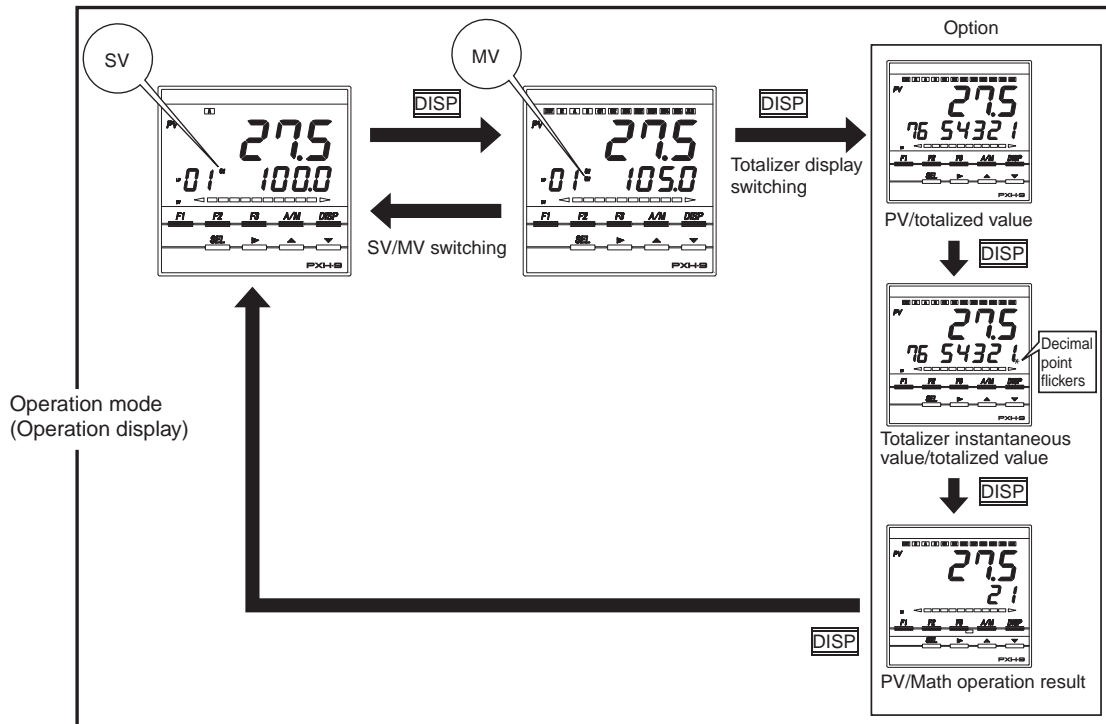

Channel selection

Password 1	Ch1	Password 2	Ch2	Ch3	Ch7	Ch8	Ch9
PS1	oPE	PS2	Pzd	PLr	Non	SEr	SYS
ChA	ChB	ChC	ChD	ChE	ChG	ChH	ChX
ALN	CoN	Lnr	CLC	AR	ΓoΓ	rS	rCP

Press SEL or [right arrow] in PS1 or PS2
 Press SEL to confirm
 Press DISP to confirm

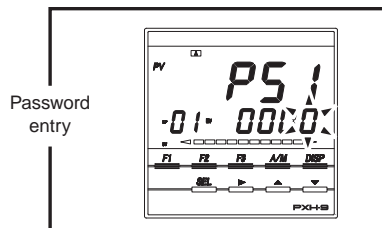

After selecting a desired channel, press SEL or [right arrow].

If the value entered does not allow PS1=PAS1 (Ch9-1) or PS2=PAS2 (Ch9-2) to hold, the later channels cannot be selected.

Parameter selection

Parameter No.	Parameter name
01	LEn1
...	...
37	LP3

Parameter No.	Parameter name
01	HrCPD
...	...
90	H.d79

*See appended parameter list.

3-1 Setting control template

rPLT Specifying control template (Setting range: 10, 11, 13, 14, 16)











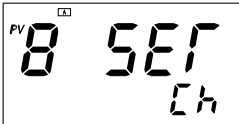

[Description]

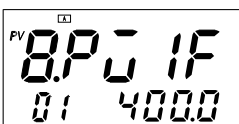
- Specify control templates.

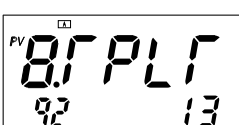
TPLT	Control template	SV selection	Math function	
10	Single-loop basic PID control (with Math function)	—	○	
11	Single-loop SV selectable PID control (with Math function)	○	○	
13	Single-loop basic PID control	—	—	<Factory set>
14	Single-loop SV selectable PID control	○	—	
16	Single-loop input selectable PID control (with Math function)	—	○	

- Each template is provided with an input conditioner function.
Input conditioner function allows the following four operations.
 - (1) User adjustment
 - (2) Square root extraction
 - (3) Input filter
 - (4) Linearize
- Math function can be selected for templates No.10, No.11, 16 and SV selection can be selected for templates No.11 and No.14. See the template chart on the next page for details.
- * See 5-14 “Math function” for Math function.
See 4-4 “SV selection” for SV selection function.

[Setting example] Setting the template to be used to 11. _____

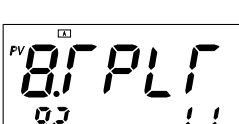
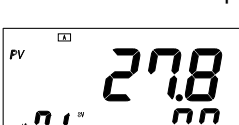
Display	Operation procedure
 <p>Operation display</p>	<p>1. Check that the operation display is shown.</p>
 <p>Channel selection display</p>	<p>2. Press the [SEL] key, and the channel selection display appears, displaying <i>P51</i>.</p>
 <p>Channel selection display</p>	<p>3. Press the  key to display <i>8 SEF</i>.</p>
 <p>Parameter selection display</p>	<p>4. Press the [SEL] or the  key, and <i>8P2 IF</i> appears and the parameter selection display is shown</p>
 <p>Parameter selection display</p>	<p>5. Press the  key to display <i>8P PLF</i>.</p>
 <p>Setting change mode</p>	<p>6. Press the [SEL] or the  key to make the setting flicker, and set the value to <i>00011</i> using the ,  or the  key.</p>
 <p>Parameter selection display</p>	<p>7. Press the [SEL] key to register the setting.</p>
 <p>Operation display</p>	<p>8. Press the [DISP] key once to return to the parameter selection display. Press it again to return to the operation display.</p>

PLF = 10 Single-loop basic PID controller (with Math function)

Contents of input conditioner

- User adjustment
- Square root extractions
- Input filter
- Linealize

1 The value obtained by calculating the input value for PV1, PV2, and Ai1 can be controlled as PV.

<Practical operations>

- Flow rate/compensation with temperature and Pressure
- Averaging (Weighting allowed)
- Maximum/minimum selector
- Input signal switching
- Calorie calculation

(See section 5-14 for details of arithmetic expressions.)

2 The same as Template No.13 except for Math function.

Note) A scale setting [UCF1, UCB1, UCD1 (Ch8-89 to 91)] must be made in accordance with the range resulting from the Math function.

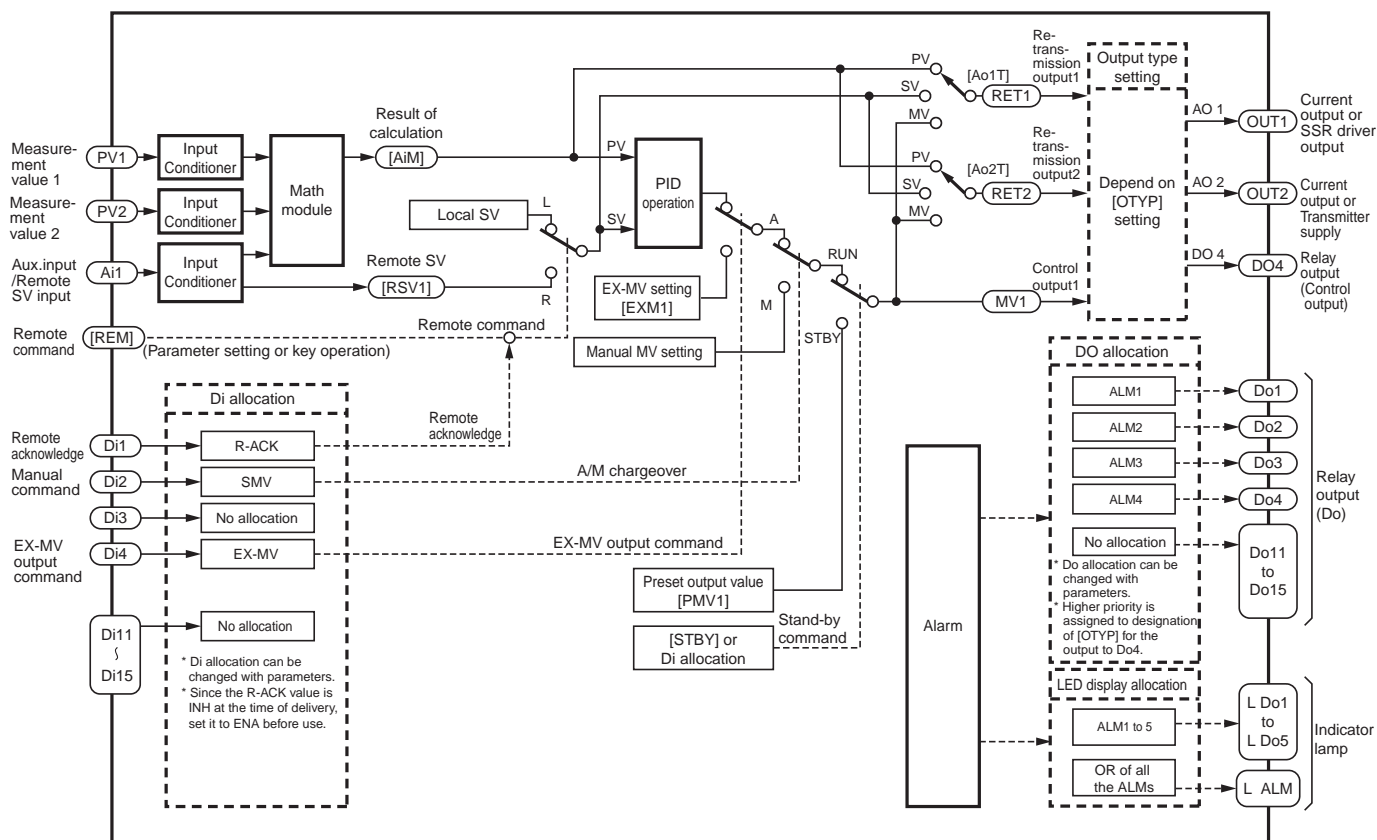

3. BASIC USAGE

RPLF =11 Single-loop SV selectable PID controller (with Math function)

- 1 The template is used to perform Math function with PV1, PV2, and Ai1 in SV selectable type control. (See item 1 in template No.10 for Math function.)
- 2 The same as template No.14 except for the Math function.
 Note) Scale setting [UCF1, UCB1, UCD1 (Ch8-89 to 91)] must be made in accordance with the range resulting from the Math function.

SV selection signal and SV number to be selected

Selection SV No.	SV selection Signal 1	SV selection Signal 2	SV selection Signal 3
Local SV	OFF	OFF	OFF
SV1	ON	OFF	OFF
SV2	OFF	ON	OFF
SV3	ON	ON	OFF
SV4	OFF	OFF	ON
SV5	ON	OFF	ON
SV6	OFF	ON	ON
SV7	ON	ON	ON

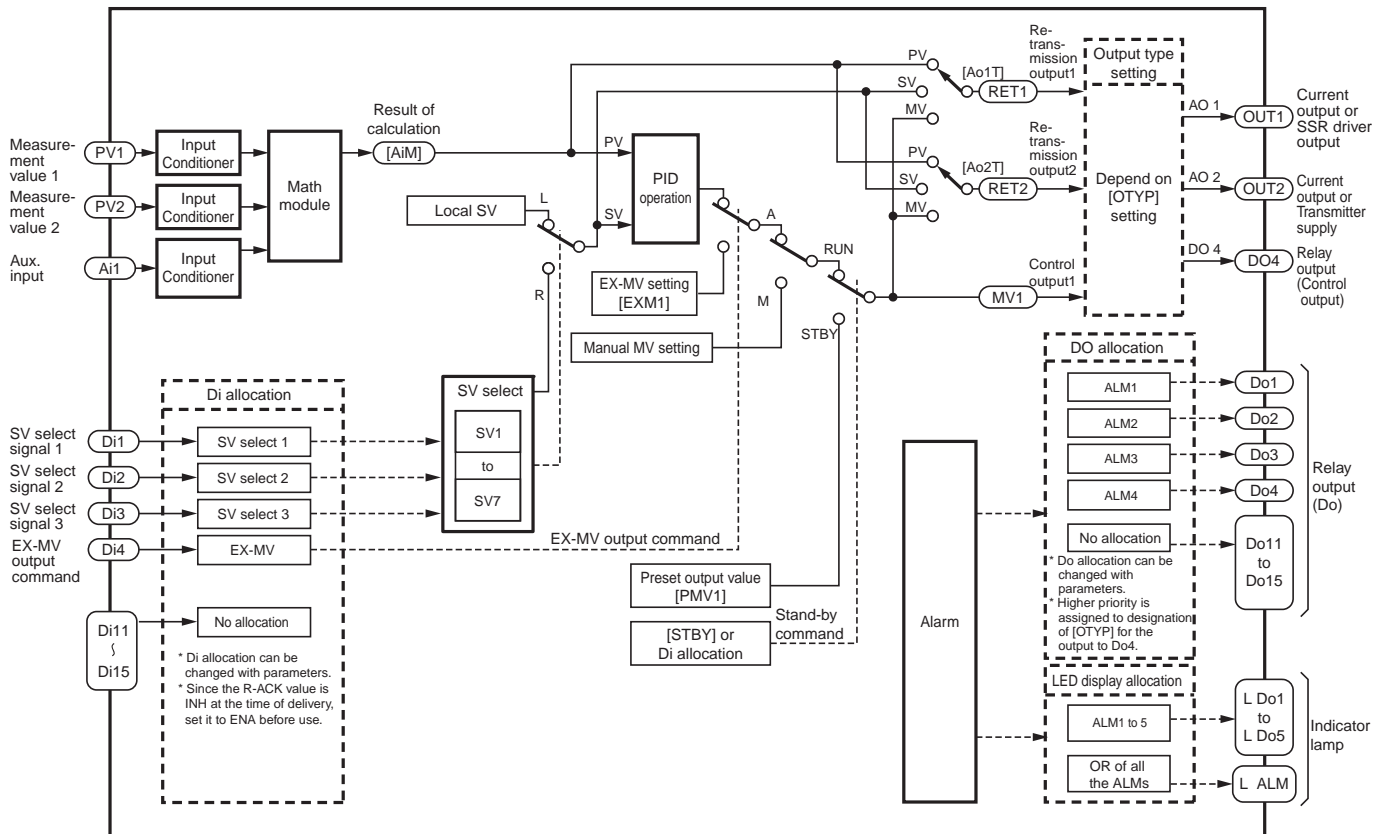

RPLF =13 Single-loop basic PID controller

Contents of input conditioner

- User adjustment
- Square root extractions
- Input filter
- Linealize

- 1 This is the most basic control template.
- 2 Control is allowed in an Auto/Manual/Remote operation mode and by digital input.
- 3 Set the control output and re-transmission output with a parameter [OTYP]. (See section 3-3 for details.)
- 4 By changing the digital input (Di) allocations, a standby operation, etc. can be performed. (See section 5-10 for details.)
- 5 Digital output (Do) and LED lamp allocations can be changed. (See section 5-11 for details.)

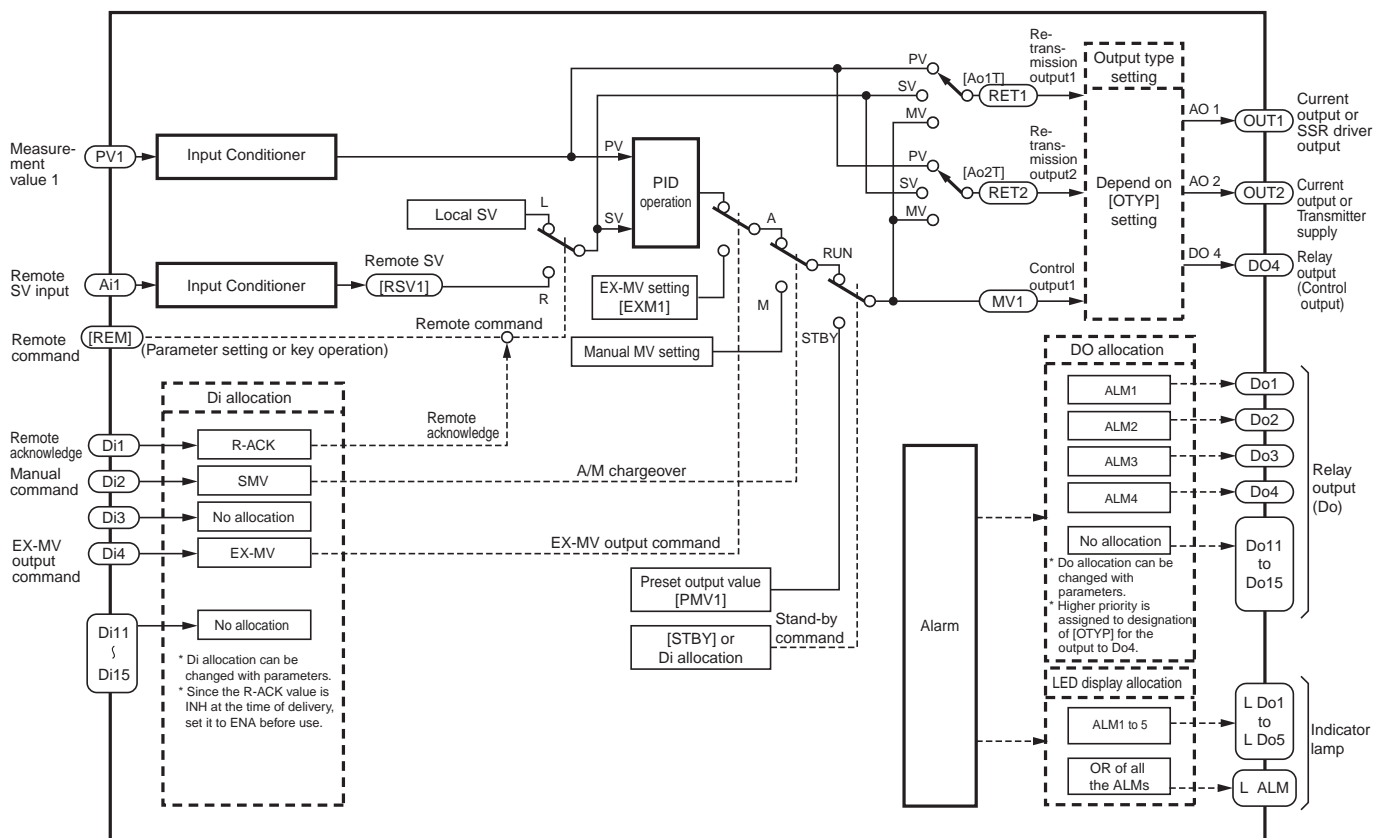

3. BASIC USAGE

RPLT =14 Single-loop SV selectable PID controller

- 1 Setting value (SV) can be selected by digital inputs. The SV can be selected from the local (front panel) setting value and 7 pairs of palette setting values (SV of ch3), 8 points in total.
 - 2 PID parameters can be switched according to the SV. (Set parameter [PLTS] (ch9-31) to "SV".) (See section 5-16 for details.)
 - 3 Set control output and re-transmission output by parameter [OTYP]. (See section 3-3 for details.)
 - 4 By changing the allocation of the digital input (Di), a standby operation, etc. can be performed. (See section 5-10 for details.)
 - 5 Digital output (Do) and LED lamp allocations can be changed. (See section 5-11 for details.)
- SV selection signals and selected SV Numbers are the same as those of template No.11.

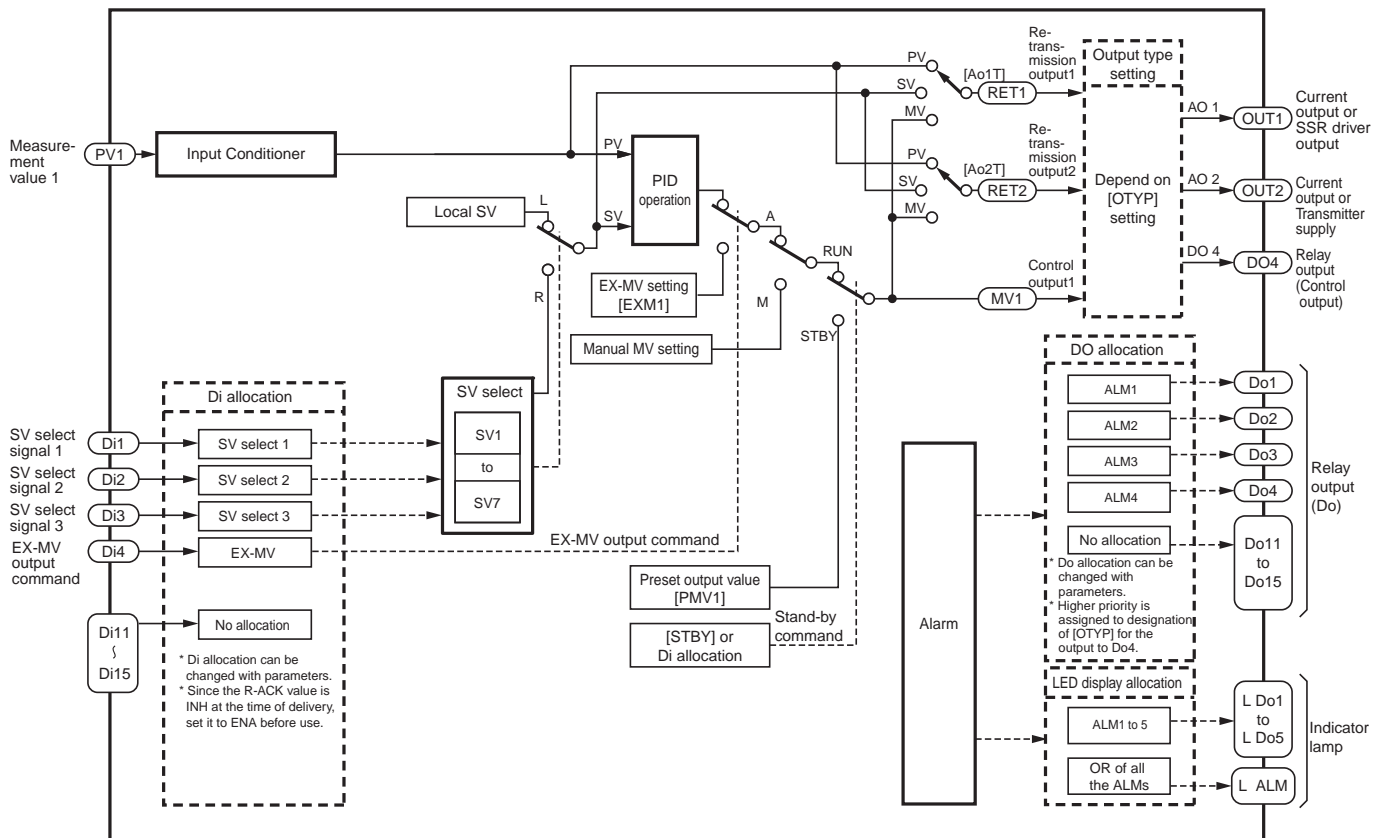

rPLT	=16
-------------	-----

Single-loop SV selectable PID controller (with Math function)

Contents of input conditioner

- User adjustment
- Square root extractions
- Input filter
- Linealize

1 Input selection function

The input for PV, RSV, EXMV, and FF (*1) can be selected.

Select each input with constant parameters (CN01 to CN05) in “CH8 (SET) input/output definition.”

See the following table for the meaning of constant parameter set values.

Set value	PV input selector	RSV input selector	EXMV input selector	FF input selector	FF operation INH command
	CN01 (CN8-98)	CN02 (CN8-99)	CN03 (CN8-A0)	CN04 (CN8-A1)	CN05 (CN8-A2)
-19999 to -1	0	0	0	0	Allowed
0	PV1 input	PV1 input	PV1 input	PV1 input	Allowed
1	PV2 input	PV2 input	PV2 input	PV2 input	Prohibited
2	Ai1 input	Ai1 input	Ai1 input	Ai1 input	Allowed
3	Math operation result	Math operation result	Math operation result	Math operation result	Allowed
4	0	0	[EXM1] parameter	0	Allowed
5 to 99999	0	0	0	0	Allowed
Initial value	0 (PV1)	2 (Ai1)	4 ([EXM1] parameter)	2 (Ai1)	1 (Prohibited)

Note: If PV2 and /or Ai1 are not fitted, those values become 0.

Note: To enable the change of input selection, reset or power off/on the main unit.

2 Math function

The result of Math operation can be used as inputs for PV, RSV, EXMV, and FF (*1).

See section 5-14 for details.

Note: Scale setting [UCF1, UCB1, UCD1 (Ch8-89 to 91)] must be made according to the range of the result of Math function.

3 Feed Forward function

The result of the following expression is added to PID operation result as Feed Forward element.

$$FF = KF1 \times (\text{Input} - B1F) + B2F$$

Set KF1, B1F, and B2F values with “Ch2 PID (control parameter).”

To use Feed Forward function, set CN05 to 0 (FF operation allowed).

4 Re-transmission output

PV, SV, MV, DV, AiM (result of Math function) or TV (Totalizer result) can be selected as a re-transmission output.

See “3-9 Re-transmission output” for details of selection method.

*1: FF stands for Feed Forward element.

PLC =16 Single-loop input selectable PID controller (with Math function)

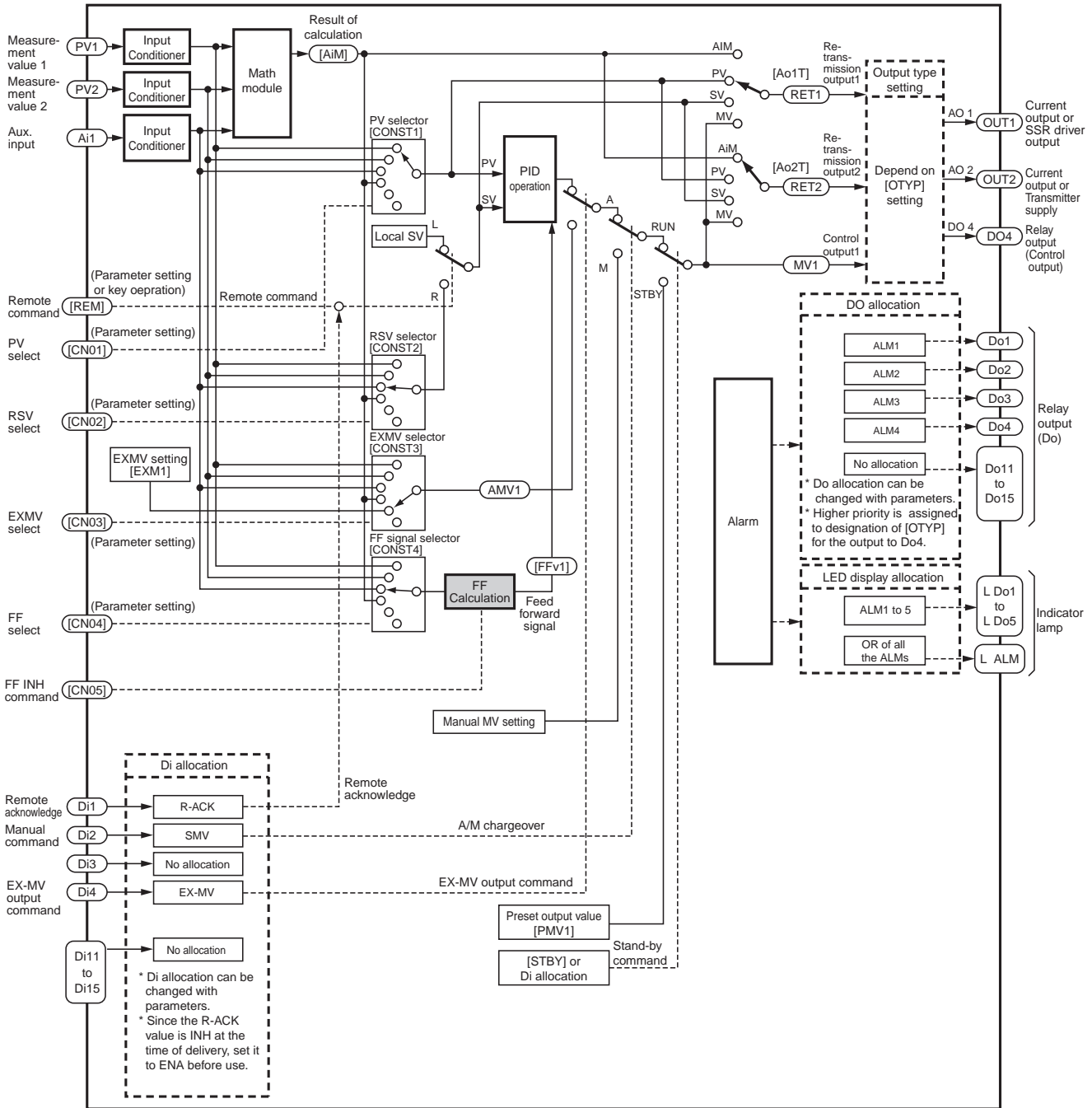

3-2 Setting input

Make the setting of each input of PV1, PV2, and Ai1.
Parameters you have to make the setting are shown below.

<PV1 input>

Parameter symbol		Meaning
$P\bar{v}1F$	Pv1F (Ch8-1)	Measurement value input (PV1) full scale setting
$P\bar{v}1b$	Pv1b (Ch8-2)	Measurement value input (PV1) base scale setting
$P\bar{v}1d$	Pv1d (Ch8-3)	Measurement value input (PV1) decimal point position setting
$P\bar{v}1T$	Pv1T (Ch8-4)	Measurement value input (PV1) input type setting
$P\bar{v}1U$	Pv1U (Ch8-5)	Measurement value input (PV1) unit setting

<PV2 input>

Parameter symbol		Meaning
$P\bar{v}2F$	Pv2F (Ch8-14)	Measurement value input (PV2) full scale setting
$P\bar{v}2b$	Pv2b (Ch8-15)	Measurement value input (PV2) base scale setting
$P\bar{v}2d$	Pv2d (Ch8-16)	Measurement value input (PV2) decimal point position setting
$P\bar{v}2T$	Pv2T (Ch8-17)	Measurement value input (PV2) input type setting
$P\bar{v}2U$	Pv2U (Ch8-18)	Measurement value input (PV2) unit setting

<Ai1 input>

Parameter symbol		Meaning
$Ai1F$	Ai1F (Ch8-40)	Analog input (Ai1) full scale setting
$Ai1b$	Ai1b (Ch8-41)	Analog input (Ai1) base scale setting
$Ai1d$	Ai1d (Ch8-42)	Analog input (Ai1) decimal point position setting
$Ai1T$	Ai1T (Ch8-43)	Analog input (Ai1) input type setting

- Subsequent descriptions are given with PV1 taken as example. To use PV2 or Ai1, check the above parameter symbols, and make the setting, following the same procedure.

Note

- To enable the setting, reset the main unit. See 3-4 “Reset command” for resetting procedure. Check whether the setting has been enabled with the display and parameter setting on the operation screen.

3. BASIC USAGE

PV 1F

Measurement value input (PV1) full scale (Setting range: -19999 to 99999)

PV 1b

Measurement value input (PV1) base scale (Setting range: -19999 to 99999)

[Description]

- Set the upper limit PV1F (Ch8-1) and the lower limit PV1b (Ch8-2) of the measurement range.
- Select decimal point position with Pv1d (Ch8-3), and input type with Pv1T (Ch8-4).
- See the following table for details of input range.
- To use Pv2 and Ai1, set Pv2F (Ch8-14), Pv2b (Ch8-15), Ai1F (Ch8-40), and Ai1b (Ch8-41), following the same procedure.

Input Type		Measurement Range (°C)	Measurement Range (°F)
Resistance bulb (RTD) IEC	Pt100Ω	0 to 150	32 to 302
		0 to 300	32 to 572
		0 to 500	32 to 932
		0 to 600	32 to 1112
		-50 to 100	-58 to 212
		-100 to 200	-148 to 392
		-150 to 600	-238 to 1112
		-150 to 850	-238 to 1562

- To use Zener barrier for RTD input, user adjustment (section 5-9) is required.

Note 1)

R thermocouple 0 to 500°C } Proper values may not be displayed within these ranges due to the sensor's characteristics.
 B thermocouple 0 to 400°C }

Note 2) When using at the settings below the minimum range stated in the table above, the input accuracy is not guaranteed.









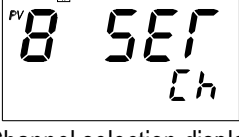

Note 3) In the -50%FS to +50%FS display, values under -199.99 will not be displayed.

Input Type		Measurement Range (°C)	Measurement Range (°F)
Thermocouple	J	0 to 400	32 to 752
	J	0 to 1000	32 to 1832
	K	0 to 400	32 to 752
	K	0 to 800	32 to 1472
	K	0 to 1200	32 to 2192
	R	0 to 1600	32 to 2912
	B	0 to 1800	32 to 3272
	S	0 to 1600	32 to 2912
	T	-200 to 200	-328 to 392
	T	-200 to 400	-328 to 752
	E	0 to 800	32 to 1472
	E	-200 to 800	-328 to 1472
	PR40/20	0 to 1800	32 to 3272
	N	0 to 1300	32 to 2372
PL-II	0 to 1300	32 to 2372	
WRe5-26	0 to 2300	32 to 4172	
DC voltage	1 to 5V DC 0 to 5V DC 0 to 10V DC 0 to 10mV DC 0 to 50mV DC	-19999 to 99999 (Scaling is possible)	
	DC current		

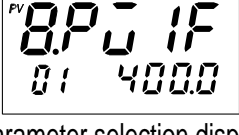
Note

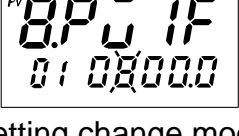
- To enable the setting, reset the main unit. See section 3-4 "Reset command" for resetting procedure.
 Check whether the setting has been enabled with the display and parameter setting on the operation screen.

[Setting example] Changing scale to "0 to 800"

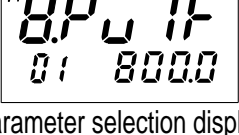
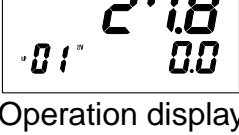
Display	Operation procedure
 <p>Operation display</p>	<p>1. Check that the operation display is shown.</p>
 <p>Channel selection display</p>	<p>2. Press the SEL key, and the channel selection display appears, displaying <i>P51</i>.</p>
 <p>Channel selection display</p>	<p>3. Press the  key to display <i>8 SER</i>.</p>
 <p>Parameter selection display</p>	<p>4. Press the SEL or the  key, and <i>8P0 IF</i> appears and the parameter selection display is shown.</p>
 <p>Setting change mode</p>	<p>5. Press the SEL or the  key to make the setting flicker, and set the value to <i>08000</i> using the , , or the  key.</p>
 <p>Parameter selection display</p>	<p>6. Press the SEL key to register the setting.</p>
 <p>Operation display</p>	<p>7. Press the DISP key once to return to the parameter selection display. Press it again to return to the operation display.</p>

Note

- To enable the setting, reset the main unit. See section 3-4 "Reset command" for resetting procedure. Check whether the setting has been enabled with the display and parameter setting on the operation screen.

3. BASIC USAGE

Pv1d Measurement value input (PV1) decimal point position (Setting range: 0 to 3)

[Description]

- Select the decimal point position of the measurement input value (PV1).

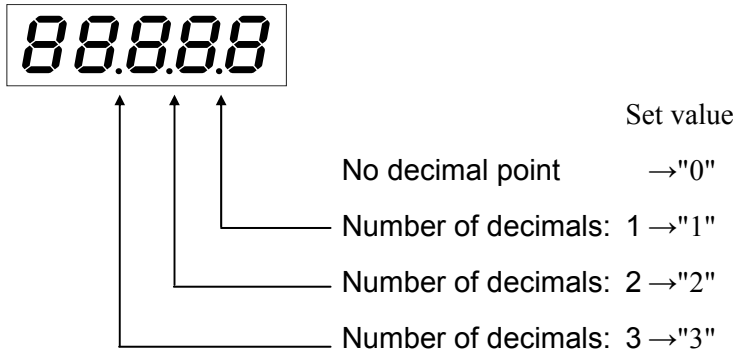









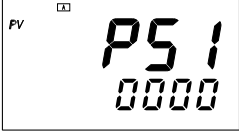
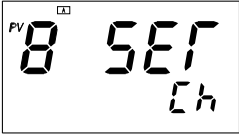

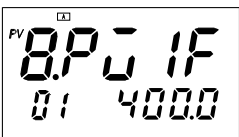
- To use PV2 or Ai1, set Pv2d (Ch8-16) or Ai1d (Ch8-42), following the same procedure.

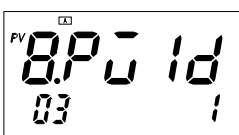
Note

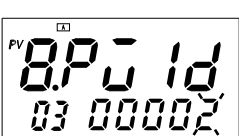
- To enable the setting, reset the main unit. See section 3-4 "Reset command" for resetting procedure. Check whether the setting has been enabled with the display and parameter setting on the operation screen.

[Setting example] Selecting 2 decimal places

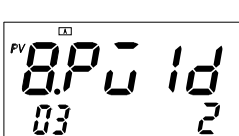
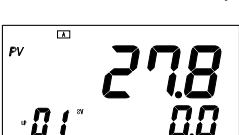
Display	Operation procedure
 <p>Operation display</p>	<p>1. Check that the operation display is shown.</p>
 <p>Channel selection display</p>	<p>2. Press the SEL key, and the channel selection display appears, displaying <i>P51</i>.</p>
 <p>Channel selection display</p>	<p>3. Press the  key to display <i>8 SEF</i>.</p>
 <p>Parameter selection display</p>	<p>4. Press the SEL or the  key, and <i>8.PU IF</i> appears and the parameter selection display is shown.</p>
 <p>Parameter selection display</p>	<p>5. Press the  key to display <i>8.PU Id</i>.</p>
 <p>Setting change mode</p>	<p>6. Press the SEL or the  key to make the setting flicker, and set the value to <i>00002</i> using the , , or the  key.</p>
 <p>Parameter selection display</p>	<p>7. Press the SEL key to register the setting.</p>
 <p>Operation display</p>	<p>8. Press the DISP key once to return to the parameter selection display. Press it again to return to the operation display.</p>

3. BASIC USAGE

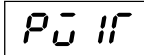

Setting input type of measurement value input (PV1) (Setting range: 0 to 27)

[Description]

- Specify input type.
- See the following table for details of input type and setting (input code).





Input Type	Code
Resistance bulb	
· Pt100Ω (IEC)	1
Thermocouple	
· J	2
· K	3
· R	4
· B	5
· S	6
· T	7
· E	8
· PR40/20	9

Input Type	Code
· N	12
· PL-II	13
· WRe5-26	14
DC voltage	
· 1 to 5V DC	16
· 0 to 5V DC	17
· 0 to 10V DC	18
· 0 to 10mV DC	19
· 0 to 50mV DC	20
DC current	
· 4 to 20mA DC	26
· 0 to 20mA DC	27

*For Ai1, only DC voltage (code 16 to 18) settings are possible.

- To use PV2 or Ai1, set Pv2T (Ch8-17) or Ai1T (Ch8-43), following the same procedure.

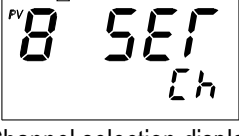
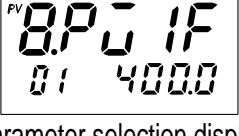
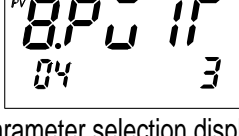
[Setting example] Selecting thermocouple J input

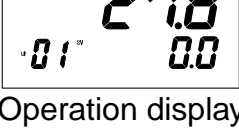
Display	Operation procedure
 <p>Operation display</p>	<p>1. Check that the operation display is shown.</p>
 <p>Channel selection display</p>	<p>2. Press the [SEL] key, and the channel selection display appears, displaying <i>P51</i>.</p>
 <p>Channel selection display</p>	<p>3. Press the [▽] key to display <i>B5EF</i>.</p>
 <p>Parameter selection display</p>	<p>4. Press the [SEL] or the [▶] key, and <i>8P0IF</i> appears and the parameter selection display is shown.</p>
 <p>Parameter selection display</p>	<p>5. Press the [▽] key to display <i>8P0IF</i>.</p>
 <p>Setting change mode</p>	<p>6. Press the [SEL] or the [▶] key to make the setting flicker, and set the value to <i>00002</i> using the [▶], [▲], or the [▽] key.</p>
 <p>Parameter selection display</p>	<p>7. Press the [SEL] key to register the setting.</p>
 <p>Operation display</p>	<p>8. Press the [DISP] key once to return to the parameter selection display. Press it again to return to the operation display.</p>







3. BASIC USAGE

Pv 1U Selecting the unit of measurement value input (PV1) (Setting range: non, °F, °C)

[Description]

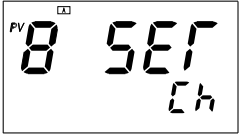
- Select a measurement unit from the following.
 - non : No unit
 - °F : °F unit
 - °C : °C unit
- To use PV2, set Pv2U (Ch8-18), following the same procedure.

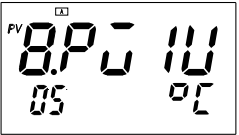
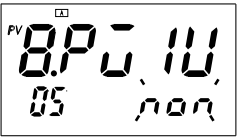
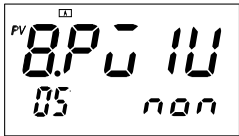
[Setting example] Changing the unit from °C to non

Display	Operation procedure
 <p>Operation display</p>	<p>1. Check that the operation display is shown.</p>
 <p>Channel selection display</p>	<p>2. Press the [SEL] key, and the channel selection display appears, displaying <i>P51</i>.</p>
 <p>Channel selection display</p>	<p>3. Press the [▽] key to display <i>B SER</i>.</p>
 <p>Parameter selection display</p>	<p>4. Press the [SEL] or the [▶] key, and <i>8.PC IF</i> appears and the parameter selection display is shown.</p>
 <p>Parameter selection display</p>	<p>5. Press the [▽] key to display <i>8.PC IU</i>.</p>
 <p>Setting change mode</p>	<p>6. Press the [SEL] or the [▶] key to make the setting flicker, and set the value to <i>non</i> using the [▶], [▲], or the [▽] key.</p>
 <p>Parameter selection display</p>	<p>7. Press the [SEL] key to register the setting.</p>
 <p>Operation display</p>	<p>8. Press the [DISP] key once to return to the parameter selection display. Press it again to return to the operation display.</p>

3-3 Setting output type







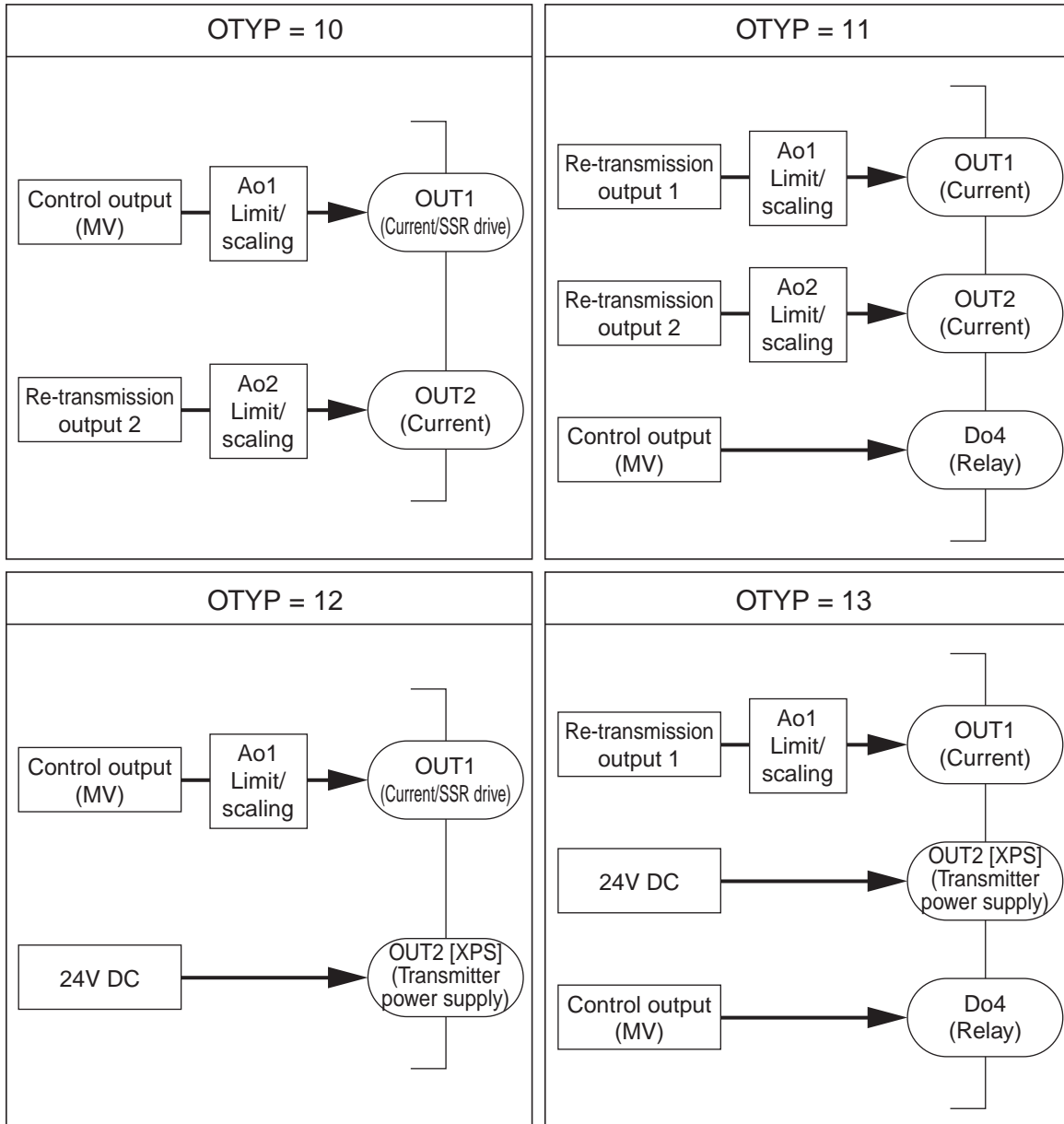





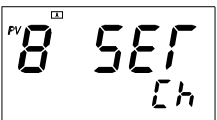

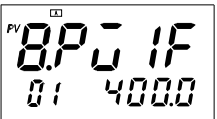
oTYP Selecting output type (Setting range: 10 to 13)

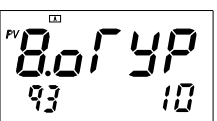
[Description]

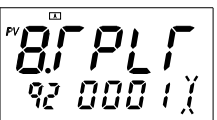
- Select a control output type according to applications.
- See the following figure for details of each output type.

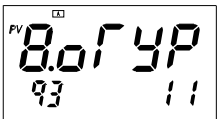

[Setting example] Changing the setting so that both the relay as control output and 2 points of current outputs as re-transmission output can be used

Display	Operation procedure
 <p>Operation display</p>	<p>1. Check that the operation display is shown.</p>
 <p>Channel selection display</p>	<p>2. Press the SEL key, and the channel selection display appears, displaying <i>P51</i>.</p>
 <p>Channel selection display</p>	<p>3. Press the  key to display <i>8 SET</i>.</p>
 <p>Parameter selection display</p>	<p>4. Press the SEL or the  key, and <i>8P2 IF</i> appears and the parameter selection display is shown.</p>
 <p>Parameter selection display</p>	<p>5. Press the  key to display <i>8.0rYP</i>.</p>
 <p>Setting change mode</p>	<p>6. Press the SEL or the  key to make the setting flicker, and set the value to <i>00011</i> using the , , or the  key.</p>
 <p>Parameter selection display</p>	<p>7. Press the SEL key to register the setting.</p>
 <p>Operation display</p>	<p>8. Press the DISP key once to return to the parameter selection display. Press it again to return to the operation display.</p>













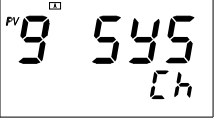

3-4 Reset command

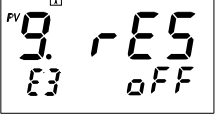
$rE5$ Resetting the main unit (Setting range: ON, OFF)

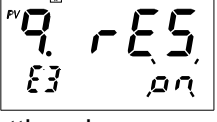
[Description]

- Selecting ON to reset the main unit.
- To enable parameters selected for Ch8, Ch9, ChB, and Ch2 (rEv1), reset the main unit or turn on the power again.

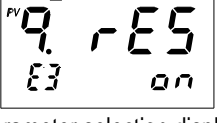
[Setting example] Resetting

Display	Operation procedure
 <p>Operation display</p>	<p>1. Check that the operation display is shown.</p>
 <p>Channel selection display</p>	<p>2. Press the SEL key, and the channel selection display appears, displaying <i>PS1</i>.</p>
 <p>Channel selection display</p>	<p>3. Press the  key to display <i>9 545</i>.</p>
 <p>Parameter selection display</p>	<p>4. Press the SEL or the  key, and <i>9PR51</i> appears and the parameter selection display is shown.</p>
 <p>Parameter selection display</p>	<p>5. Press the  key to display <i>9 rES</i>.</p>
 <p>Setting change mode</p>	<p>6. Press the SEL or the  key to make the setting flicker, and set the value to <i>on</i> using the , , or the  key.</p>
 <p>Parameter selection display</p>	<p>7. Press the SEL key to register the setting.</p>
 <p>Operation display</p>	<p>8. “WAIT RESET” appears and the bar graph comes on. After resetting is completed, the operation display automatically appears.</p> <p>* Resetting takes approx. 10 seconds.</p>

3-5 Setting control parameter

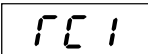
 Proportion cycle of control output (MV) (Setting range: 1 to 150 sec)

[Description]

- The setting is applicable to relay output and SSR drive output.
- While input is kept within the proportional band, output is turned ON/OFF at fixed intervals, which is called proportion cycle.
By making the proportion cycle time shorter, ON-OFF switching time of the operation unit is made shorter, which allows delicate control.

In the case of contact output

The higher the output frequency is, the more delicate control is assured, but service life of the contact and operation device is made shorter. Adjust the proportion cycle time to acquire balance between controllability and service life.







Recommended value: 30 sec or more

In the case of SSR drive output

If there is no trouble with the operation device, select short time setting.

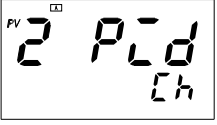
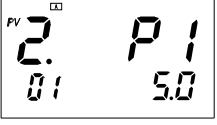
Recommended value: 1 sec or more

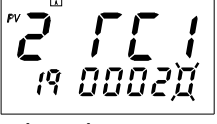
[Setting example] Changing proportion cycle from 30 sec to 20 sec

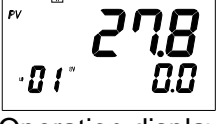
Display	Operation procedure
 <p>Operation display</p>	<p>1. Check that the operation display is shown.</p>
 <p>Channel selection display</p>	<p>2. Press the [SEL] key, and the channel selection display appears, displaying <i>PS1</i>.</p>
 <p>Channel selection display</p>	<p>3. Press the [▽] key to display <i>2 PId</i>.</p>
 <p>Parameter selection display</p>	<p>4. Press the [SEL] or the [▶] key, and <i>2 P1</i> appears and the parameter selection display is shown.</p>
 <p>Parameter selection display</p>	<p>5. Press the [▽] key to display <i>2 P1</i>.</p>
 <p>Setting change mode</p>	<p>6. Press the [SEL] or the [▶] key to make the setting flicker, and set the value to <i>00020</i> using the [▶], [▲], or the [▽] key.</p>
 <p>Parameter selection display</p>	<p>7. Press the [SEL] key to register the setting.</p>
 <p>Operation display</p>	<p>8. Press the [DISP] key once to return to the parameter selection display. Press it again to return to the operation display.</p>

3. BASIC USAGE

REV Control action type (Setting range: NRML, REV)

[Description]



- There are two control action types. One is normal (direct) action, and the other is reverse action.

NRML (Normal (direct) action): If measurement value (PV) becomes larger than the set value (SV), control output becomes larger.

REV (Reverse action): If measurement value (PV) becomes smaller than the set value (SV), control output becomes larger.

Control action type	Application
NRML (Normal action)	Cooling control
REV (Reverse action)	Heating control

[Setting example] Changing control action type from REV to NRML

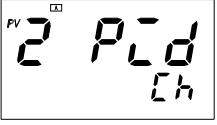
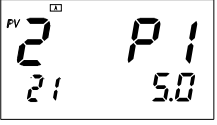
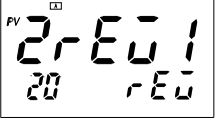
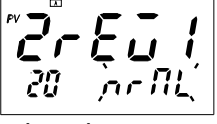
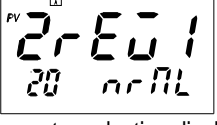
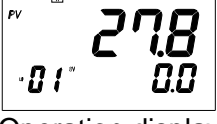
Display	Operation procedure
 <p>Operation display</p>	<p>1. Check that the operation display is shown.</p>
 <p>Channel selection display</p>	<p>2. Press the [SEL] key, and the channel selection display appears, displaying <i>PS1</i>.</p>
 <p>Channel selection display</p>	<p>3. Press the [▽] key to display <i>2 PId</i>.</p>
 <p>Parameter selection display</p>	<p>4. Press the [SEL] or the [▶] key, and <i>2 P1</i> appears and the parameter selection display is shown.</p>
 <p>Parameter selection display</p>	<p>5. Press the [▽] key to display <i>2 REV1</i>.</p>
 <p>Setting change mode</p>	<p>6. Press the [SEL] or the [▶] key to make the setting flicker, and set the value to <i>nrml</i> using the [▶], [▲], or the [▽] key.</p>
 <p>Parameter selection display</p>	<p>7. Press the [SEL] key to register the setting.</p>
 <p>Operation display</p>	<p>8. Press the [DISP] key once to return to the parameter selection display. Press it again to return to the operation display.</p>











3-6 Setting the set value (SV)

Setting the set value (SV)

[Description]

- Set value (SV) is the target value of the control.
- The upper limit value and the lower limit value of the setting can be set with Sh1 (Ch2-7) and SL1 (Ch2-8).

[Setting example] Changing the set value (SV) from 0.0°C to 60.0°C _____

Display	Operation procedure
 <p>Operation display</p>	<p>1. Check that “SV 00 ” is shown on the operation display.</p>
 <p>SV change mode</p>	<p>2. Press the  key to make the SV flicker.</p> <p>3. Set the SV value to 00600 using the , , or the  key.</p>
 <p>Operation display</p>	<p>4. Press the  key to complete the operation.</p> <p>* If the [DISP] key is pressed while the setting is flickering, or no operation status continues for 10 seconds or longer, the value being changed is canceled.</p> <p>* The SV can also be changed without making the value flicker by pressing the  key. Just change the value using the  or the  key.</p>

[Note]

- Setting value (SV) can not be changed during Ramp/soak operation.

Sh1 SV upper limit value (Setting range: -25 to 125%FS)

SL1 SV lower limit value (Setting range: -25 to 125%FS)

[Description]

- Set the settable range of set value (SV).
- The SV upper and lower limit values, Sh1 (Ch2-7) and SL1 (Ch2-8), can be set within the range of Pv1 scale from Pv1F (Ch8-1) to Pv1b (Ch8-2). (See the following figure.)

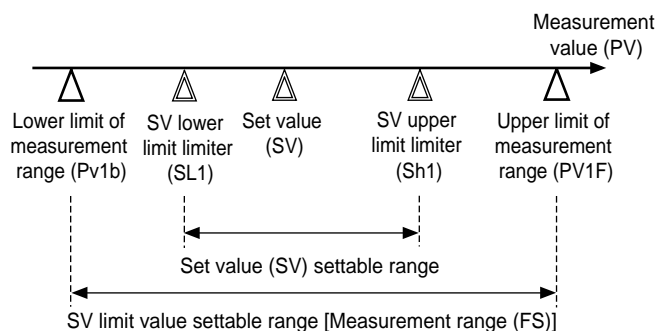

[Note]

- Be sure to set the following parameters before setting Sh1 (Ch2-7) and SL1 (Ch2-8) parameters.
 - Measurement range upper limit setting Pv1F (Ch8-1)
 - Measurement range lower limit setting Pv1b (Ch8-2)
 - Decimal point position Pv1d (Ch8-3)
- After changing Pv1F (Ch8-1), Pv1b (Ch8-2), and Pv1d (Ch8-3) parameters, reset the controller, and then set Sh1 (Ch2-7) and SL1 (Ch2-8) parameters.
- Set the limit values so that Sh1 (Ch2-7) becomes equal or larger than SL1 (Ch2-8).

3-7 AT (Auto tuning)

AT Auto tuning function (Setting range: OFF, ON1)

ATP1 Setting auto tuning method (Setting range:NRML, LPV)

[Description]

- The controller automatically measures, calculates, and sets PID constant, which is called auto tuning. Perform auto tuning after setting of input range (Pv1F (Ch8-1), Pv1b (Ch8-2), Pv1d (Ch8-3)), set value (SV), and proportion cycle TC1 (Ch2-19) is completed.
- When auto tuning is normally completed, the automatically set PID parameter value is maintained even if the power is turned off. If the power is turned off during the process of auto tuning, start again from the beginning. (PID value does not change.)
- Since ON-OFF operation (2-position operation) is performed during auto tuning, PV may fluctuate greatly depending on the process. Do not perform auto tuning for the processes where great fluctuation of PV is not allowed. Do not perform auto tuning, either, for the processes where the response is quick, such as pressure control or flow rate control.
- If auto tuning is not completed in 4 hours, it may not be performed properly. Check input/output wiring and parameters such as control output (forward, reverse) and input sensor type.
- If input range (Pv1F (Ch8-1), Pv1b (Ch8-2), and Pv1d (Ch8-3)) is changed or the operation of control target is changed because a great change is made to the SV, perform auto tuning again.





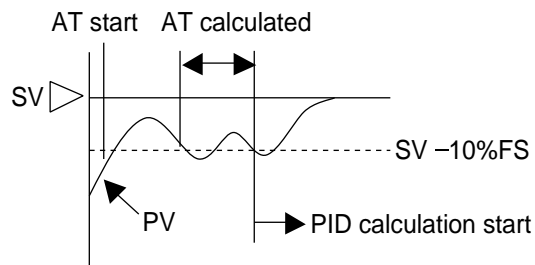
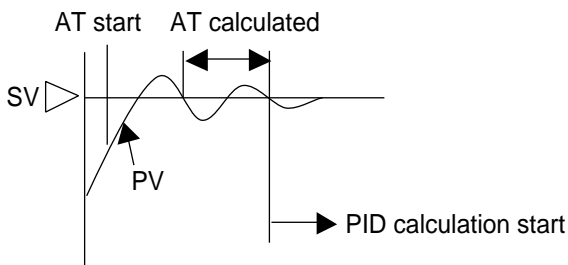

Parameter		Description
Ch E	ATP1	Auto tuning type MRML: Standard type (with reference to SV) LPV: Low PV type (With reference to SV -10%FS)
Ch 1	PLFN	Palette No. used for control (Reflect the result of AT.) 0: Local PID 1 to 7: Palettes No.1 to 7

(1) Standard type (ATP1=NRML)

(2) Low PV type (ATP1=LPV)
Overshoot at the time of tuning is reduced.

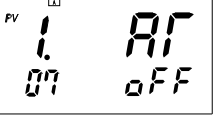
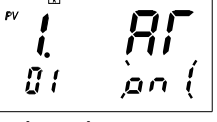
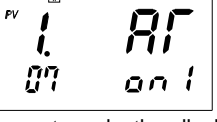

[Setting example] Performing auto tuning

Display	Operation procedure
 <p>Operation display</p>	<p>1. Check that the operation display is shown.</p>
 <p>Channel selection display</p>	<p>2. Press the [SEL] key, and the channel selection display appears, displaying <i>PS1</i>.</p>
 <p>Channel selection display</p>	<p>3. Press the [▽] key to display <i>1 oPE</i>.</p>
 <p>Parameter selection display</p>	<p>4. Press the [SEL] or the [▶] key, and <i>1-EN1</i> appears and the parameter selection display is shown.</p>
 <p>Parameter selection display</p>	<p>5. Press the [▽] key to display <i>1 AF</i>.</p>
 <p>Setting change mode</p>	<p>6. Press the [SEL] or the [▶] key to make the setting flicker, and set the value to <i>on</i> using the [▶], [▲], or the [▽] key.</p>
 <p>Parameter selection display</p>	<p>7. Press the [SEL] key to register the setting.</p>
 <p>Operation display</p>	<p>8. Press the [DISP] key once to return to the parameter selection display. Press it again to return to the operation display.</p>

* While auto tuning is in progress, the decimal point of the figure on the right of the lower row is kept flickering. It goes off when auto tuning is completed.

3-8 Alarm function

1TP to **8TP** Setting alarm type (Setting range: 0 to 38)

[Description]

- Set the operation type of alarms 1 to 8.
- See the following figure for details of alarm type.

	1TP to 8TP	Alarm Type	Operation Diagram
	0	No alarm	
Absolute value Alarm	1	Upper limit absolute	
	2	Lower limit absolute	
	3	Upper limit absolute (with hold)	
	4	Lower limit absolute (with hold)	
Deviation Alarm	5	Upper limit deviation	
	6	Lower limit deviation	
	7	Upper/lower limit deviation	
	8	Upper limit deviation (with hold)	
	9	Lower limit deviation (with hold)	
	10	Upper/lower limit deviation (with hold)	
Range Alarm	11	Range upper/lower limit deviation	

Caution The Hold Function:





This is an alarm for situations when the alarm does not turn ON immediately, and the value goes outside the range once and then reenters within the range, even when the measured value is within the range of the alarm at the time the power is turned on.

Notes

- After changing the alarm type, confirm the alarm setting values. Alarm setting values may change by changing the alarm type, but this is normal.
- Caution: The alarm latch function cannot be used when using the OFF delay timer.
- ALn : Indicates the AL1 (ch1-10) to AL8 (ch1-31) alarm setting values.
- An-H : Indicates the A1-H (ch1-12) to A8-H (ch1-33) alarm setting values.
- An-L : Indicates the A1-L (ch1-11) to A8-L (ch1-32) alarm setting values.
- dLYn : Indicates the 1dLY (chA-4) to 8dLY (chA-39) alarm ON delay setting values.

	1TP to 8TP	Alarm Type	Operation Diagram	
Upper/lower limit Alarm	16	Upper/lower limit absolute		
	17	Upper/lower limit deviation		
	18	Upper limit absolute Lower limit deviation		
	19	Lower limit absolute Upper limit deviation		
	20	Upper/lower limit absolute (with hold)		
	21	Upper/lower limit deviation (with hold)		
	22	Upper limit absolute Lower limit deviation (with hold)		
	23	Upper limit deviation Lower limit absolute (with hold)		
	Range Alarm	24	Range upper/lower limit absolute	
		25	Range upper limit/lower limit deviation	
26		Range upper limit absolute Lower limit deviation		
27		Range upper limit deviation Lower limit absolute		
28		Range upper limit/lower limit absolute (with hold)		
29		Range upper limit/lower limit deviation (with hold)		
30		Range upper limit absolute Lower limit deviation (with hold)		
Limit	31	Range upper limit deviation Lower limit absolute (with hold)		
	32	SV upper/lower limit		
	35	PV rate of change Upper/lower limit		
Timer	36	ON delay timer		
	37	OFF delay timer		
	38	ON/OFF delay timer		

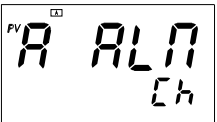
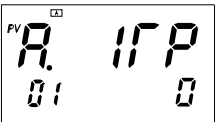
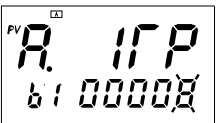
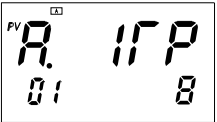
[Setting example] Setting alarm type of Alarm 1 to upper limit deviation (with hold) _____

Display	Operation procedure
 <p>Operation display</p>	<p>1. Check that the operation display is shown.</p>
 <p>Channel selection display</p>	<p>2. Press the [SEL] key, and the channel selection display appears, displaying <i>PS1</i>.</p>
 <p>Channel selection display</p>	<p>3. Press the [▽] key to display <i>A ALN</i>.</p>
 <p>Parameter selection display</p>	<p>4. Press the [SEL] or the [▶] key, and <i>A I/P</i> appears and the parameter selection display is shown.</p>
 <p>Setting change mode</p>	<p>5. Press the [SEL] or the [▶] key to make the setting flicker, and set the value to <i>00008</i> using the [▶], [▲], or the [▽] key.</p>
 <p>Parameter selection display</p>	<p>6. Press the [SEL] key to register the setting.</p>
 <p>Operation display</p>	<p>7. Press the [DISP] key once to return to the parameter selection display. Press it again to return to the operation display.</p>

3. BASIC USAGE

10P to **80P** Setting alarm options (Setting range: 0000 to 1111)

[Description]

Setting alarm options

- Switching of alarm unit (time) and function setting can be made. (See the following figure).

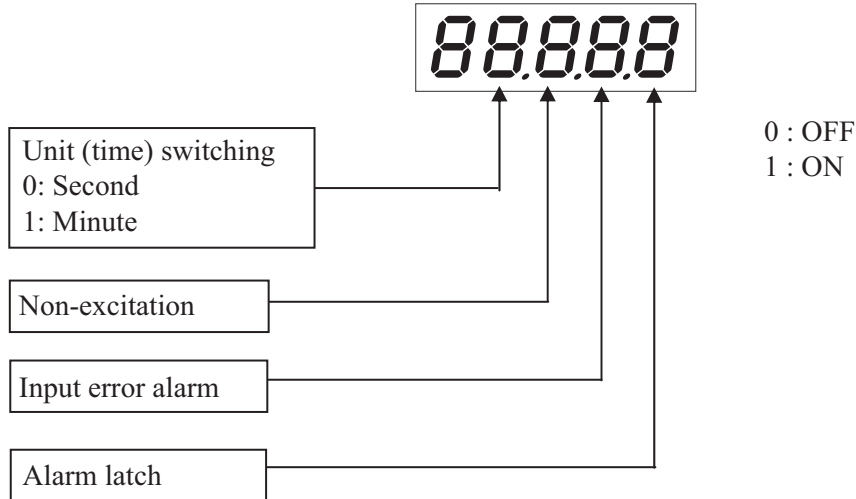

- Unit (time) switching is used for 1dLY (ChA-4) to 8dLY (ChA-39).

What is the excitation/non excitation function?

It is a function that makes the alarm output excited or not excited and outputs to the alarm relay. (When the function is set to ON, the alarm is output when not excited.)

Excitation/non excitation function

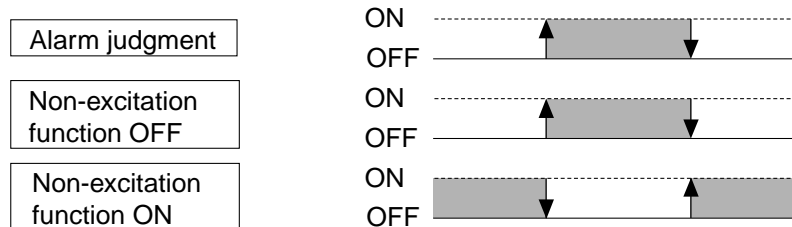

[Note]

If power is turned OFF or during standby, alarm is not output (OFF) even if non-excitation function is set to ON.

What is input error alarm function?



It is a function that turns ON the alarm relay when an error occurs to the main unit.

What is alarm latch function?

It is a function that maintains alarm ON status once the alarm is turned ON. Following procedures are available to reset the alarm latch.

- 1) Turn on the power of the controller again.
- 2) Set the alarm latch setting to OFF.
- 3) Reset using the alarm latch reset command LACH (Ch1-8).
- 4) Reset by DI input.
- 5) Reset by communication.

[Setting example] Setting the unit to minute, non-excitation to ON, input error alarm to OFF, and alarm latch to OFF

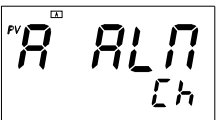
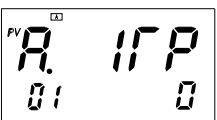
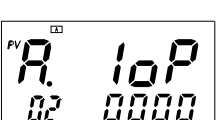
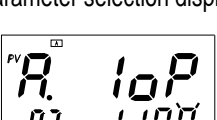
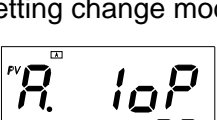
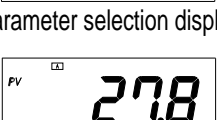
Display	Operation procedure
 <p>Operation display</p>	<p>1. Check that the operation display is shown.</p>
 <p>Channel selection display</p>	<p>2. Press the [SEL] key, and the channel selection display appears, displaying <i>PS1</i>.</p>
 <p>Channel selection display</p>	<p>3. Press the [▽] key to display <i>R ALN</i>.</p>
 <p>Parameter selection display</p>	<p>4. Press the [SEL] or the [▶] key, and <i>R I/P</i> appears and the parameter selection display is shown.</p>
 <p>Parameter selection display</p>	<p>5. Press the [▽] key to display <i>R I/P</i>.</p>
 <p>Setting change mode</p>	<p>6. Press the [SEL] or the [▶] key to make the setting flicker, and set the value to <i>1100</i> using the [▶], [▲], or the [▽] key.</p>
 <p>Parameter selection display</p>	<p>7. Press the [SEL] key to register the setting.</p>
 <p>Operation display</p>	<p>8. Press the [DISP] key once to return to the parameter selection display. Press it again to return to the operation display.</p>

3. BASIC USAGE

1dLY to **8dLY** Setting alarm delay time (Setting range: 0 to 9999)

1hYS to **8hYS** Setting alarm hysteresis (Setting range: 0.00 to 50.00%FS)

[Description]

Setting alarm delay time



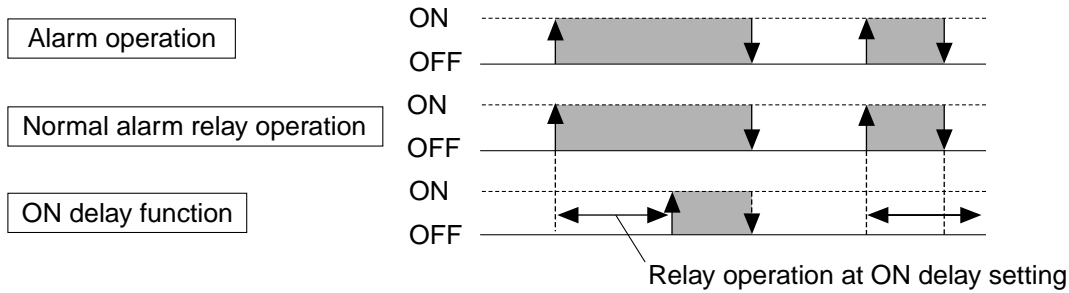









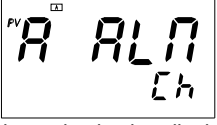

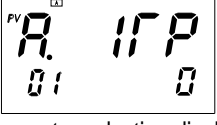
- When alarm ON conditions are met, the alarm is set to ON after selected ON delay time elapses.

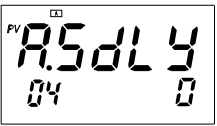

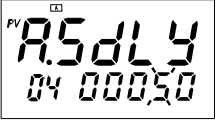
Setting alarm hysteresis

- Set the operation dead band (hysteresis).
- By setting alarm hysteresis, fluctuation of output is prevented and the output is stabilized. Setting can be made according to applications.

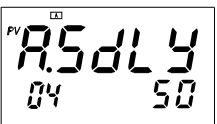
[Setting example] Setting delay time of Alarm 5 to 50

Display	Operation procedure
 <p>Operation display</p>	<p>1. Check that the operation display is shown.</p>
 <p>Channel selection display</p>	<p>2. Press the SEL key, and the channel display appears, displaying <i>P51</i>.</p>
 <p>Channel selection display</p>	<p>3. Press the  key to display <i>A ALN</i>.</p>
 <p>Parameter selection display</p>	<p>4. Press the SEL or the  key, and <i>A IRP</i> appears and the parameter selection display is shown.</p>
 <p>Parameter selection display</p>	<p>5. Press the  key to display <i>A5dLY</i>.</p>
 <p>Setting change mode</p>	<p>6. Press the SEL or the  key to make the setting flicker, and set the value to <i>00050</i> using the , , or the  key.</p>
 <p>Parameter selection display</p>	<p>7. Press the SEL key to register the setting.</p>
 <p>Operation display</p>	<p>8. Press the DISP key once to return to the parameter selection display. Press it again to return to the operation display.</p>

3. BASIC USAGE











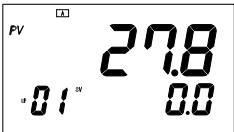

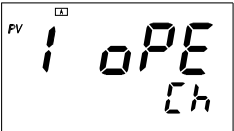

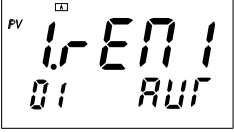
<i>AL 1</i>	to	<i>AL 8</i>	Alarm setting	}	Setting range: 0 to 100%FS for absolute value alarm, -100 to 100%FS for deviation alarm
<i>A1-L</i>	to	<i>A8-L</i>	Alarm lower limit setting		
<i>A1-h</i>	to	<i>A8-h</i>	Alarm upper limit setting		

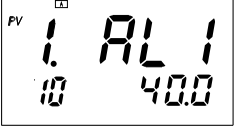
[Description]

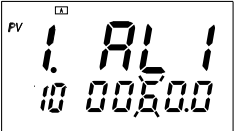
- Set the operation value of alarms from 1 to 8.
- Display/non display status of AL1 (Ch1-10) to AL8 (Ch1-31), A1-L (Ch1-11) to A8-L (Ch1-32), A1-h (Ch1-12) to A8-h (Ch1-33) changes automatically according to the type of alarms selected. (See the following table for details.)

Setting of 1TP to 8TP	Displayed parameter
1 to 11, 35	AL1 to AL8
16 to 32	A1-h to A8-h
	A1-L to A8-L

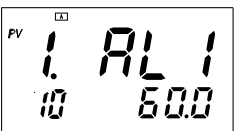
[Setting example] Setting alarm 1 setting to 60.0

Display	Operation procedure
 <p>Operation display</p>	<p>1. Check that the operation display is shown.</p>
 <p>Channel selection display</p>	<p>2. Press the SEL key, and the channel selection display appears, displaying <i>PS1</i>.</p>
 <p>Channel selection display</p>	<p>3. Press the  key to display <i>IoPE</i>.</p>
 <p>Parameter selection display</p>	<p>4. Press the SEL or the  key, and <i>I-EN1</i> appears and the parameter selection display is shown.</p>
 <p>Parameter selection display</p>	<p>5. Press the  key to display <i>I AL1</i>.</p>
 <p>Setting change mode</p>	<p>6. Press the SEL or the  key to make the setting flicker, and set the value to <i>00600</i> using the , , or the  key.</p>
 <p>Parameter selection display</p>	<p>7. Press the SEL key to register the setting.</p>
 <p>Operation display</p>	<p>8. Press the DISP key once to return to the parameter selection display. Press it again to return to the operation display.</p> <p>* When 1TP is set to 16-32, AL1 is not displayed. See the table on the previous page.</p>

3-9 Re-transmission output

Ao1T

Setting output type of re-transmission output 1 (Setting range: PV, SV, MV, DV, AiM, MVRB, TV)

[Description]

- See the following table for details of output type.





Ao1T	Meaning
PV	Measurement value (PV)
SV	Set value (SV)
MV	Operation output value (MV)
DV	Deviation (PV – SV)
AiM	Result of Math function
MVRB	Valve opening feedback (MVRB) ^{Note 1)}
TV	Totalizer result value ^{Note 2)}

- To use output scaling, make the scaling setting of Ao1H (Ch8-66) and Ao1L (Ch8-67).
- To use Ao2, make the setting of Ao2T (Ch8-70), Ao2H (Ch8-72), Ao2L (Ch8-73) in the same way.

Note 1: MVRB cannot be used.

Note 2: If [TV] is selected as re-transmission output type, make rTSC (ChG-21) setting.

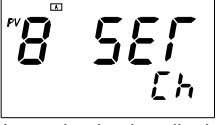
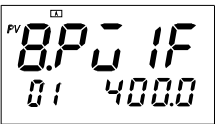
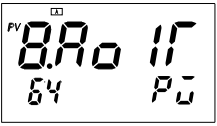
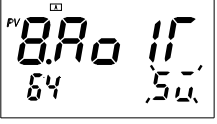
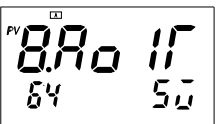
[Setting example] Changing the type of re-transmission output 1 from PV to SV _____

Display	Operation procedure
 <p>Operation display</p>	<p>1. Check that the operation display is shown.</p>
 <p>Channel selection display</p>	<p>2. Press the [SEL] key, and the channel selection display appears, displaying <i>PS1</i>.</p>
 <p>Channel selection display</p>	<p>3. Press the [▽] key to display <i>8 SET</i>.</p>
 <p>Parameter selection display</p>	<p>4. Press the [SEL] or the [▶] key, and <i>8P0 IF</i> appears and the parameter selection display is shown.</p>
 <p>Parameter selection display</p>	<p>5. Press the [▽] key to display <i>8R0 IF</i>.</p>
 <p>Setting change mode</p>	<p>6. Press the [SEL] or the [▶] key to make the setting flicker, and set the value to <i>50</i> using the [▶], [▲], or the [▽] key.</p>
 <p>Parameter selection display</p>	<p>7. Press the [SEL] key to register the setting.</p>
 <p>Operation display</p>	<p>8. Press the [DISP] key once to return to the parameter selection display. Press it again to return to the operation display.</p>

3. BASIC USAGE

Ao1h Upper limit value of the scale of re-transmission output 1 (Setting range: -130.0% to 130.0%)

Ao1L Lower limit value of the scale of re-transmission output 1 (Setting range: -130.0% to 130.0%)

[Description]

- Set the upper limit value and lower limit value of the scaling of re-transmission output.
- The unit of setting is %.

Output type	Meaning of setting value [%]	
	When TPLT=13, 14	When TPLT=10, 11, 16
PV/SV/DV	Scale set in Pv1F (Ch8-1), Pv1b (Ch8-2), Pv1d (Ch8-3)	Scale set in UCF1 (Ch8-89), UCb1 (Ch8-90), UCd1 (Ch8-91)
AiM	—	Scale set in UCF1 (Ch8-89), UCb1 (Ch8-90), UCd1 (Ch8-91)
MV/MVRB	Fixed to 0.0 to 100.0% (output value)	Fixed to 0.0 to 100.0% (output value)
TV	Scale of input type selected in Toin (ChG-3)	Scale of input type selected in Toin (ChG-3)

Note: The following is an example where scales used are PV1F, PV1b, and PV1d. Find the setting using the same expression when using other scales. (Refer also to the setting example shown below.)

$$\text{Setting (\%)} = (A / B) \times 100 (\%)$$

A = The value to be set – Setting of parameter Pv1b (Ch8-2)

B = Setting of parameter Pv1F (Ch8-1) – Setting of Pv1b (Ch8-2)

- When the value of re-transmission output type (SV for example) becomes equal to the setting of Ao1L (Ch8-67), the re-transmission output becomes 0% (output).
- When the value of re-transmission output type (PV for example) becomes equal to the setting of Ao1h (Ch8-66), the re-transmission output becomes 100% (output).
- To use this function for output 2, make the setting of Ao2h (Ch8-72) and Ao2L (Ch8-73) in the same way.
- If the scaling upper limit values Ao1h, Ao2h and the lower limit values Ao1L, Ao2L are set in reverse, the output is reversed. (See the following figure.)

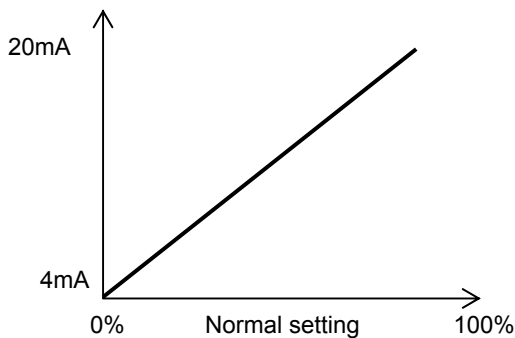

When Ao1L=0.0%, Ao1H=100.0%

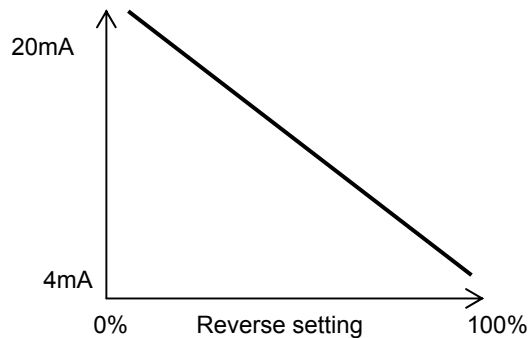











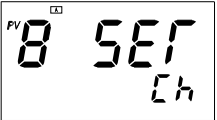

When Ao1L=100.0%, Ao1H=0.0%

[Setting example] Performing scaling to allow 0% output when PV (value of re-transmission output type) is 100°C, and 100% output when it is 300°C, with the input type of K thermocouple of 0 to 400°C







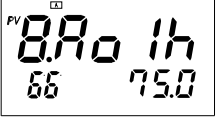



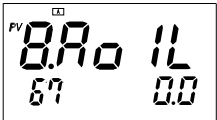

Since measurement range is from 0 to 400°C, Pv1b = 0 (lower limit value of the measurement range), and Pv1F = 400 (upper limit value of the measurement range), the values of A and B in the expression on the previous page are calculated as follows.

$A = (100^\circ\text{C} - 0)$ or $(300^\circ\text{C} - 0)$, $B = 400 - 0 = 400$

- 1) Setting of Ao1L: At what % position is 100°C in 0 to 400°C range? = 25% (= $100 - 0$) / 400×100 [%])
→ Ao1L = 25.0%
- 2) Setting of Ao1h: At what % position is 300°C in 0 to 400°C range? = 75% (= $300 - 0$) / 400×100 [%])
→ Ao1h = 75.0%

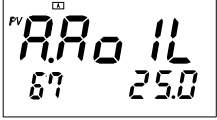
Display	Operation procedure
 <p>Operation display</p>	<ol style="list-style-type: none"> 1. Check that the operation display is shown.
 <p>Channel selection display</p>	<ol style="list-style-type: none"> 2. Press the SEL key, and the channel selection display appears, displaying <i>P51</i>.
 <p>Channel selection display</p>	<ol style="list-style-type: none"> 3. Press the  key to display <i>8 5EF</i>.
 <p>Parameter selection display</p>	<ol style="list-style-type: none"> 4. Press the SEL or the  key, and <i>8P0 IF</i> appears and the parameter selection display is shown.
 <p>Parameter selection display</p>	<ol style="list-style-type: none"> 5. Press the  key to display <i>8A0 1h</i>.
 <p>Setting change mode</p>	<ol style="list-style-type: none"> 6. Press the SEL or the  key to make the setting flicker, and set the value to <i>0075.0</i> using the , , or the  key.
 <p>Parameter selection display</p>	<ol style="list-style-type: none"> 7. Press the SEL key to complete the setting of <i>8A0 1h</i>. <p style="text-align: right;">(Continued to the next page.)</p>

3. BASIC USAGE

Display	Operation procedure
 <p>Parameter selection display</p>	<p>8. Press the  key to display <i>8A0 IL</i> .</p>
 <p>Setting change mode</p>	<p>9. Press the  or the  key to make the setting flicker, and set the value to <i>0025.0</i> using the , , or the  key.</p>
 <p>Parameter selection display</p>	<p>10. Press the  key to complete the setting of <i>8A0 IL</i> .</p>
 <p>Operation display</p>	<p>11. Press the  key once to return to the parameter selection display. Press it again to return to the operation display.</p>

A 1Lh Upper limit value of re-transmission output (Setting range: –25.0% to 105.0%)













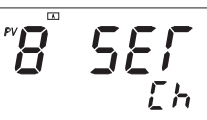

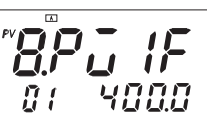
A 1Ll Lower limit value of re-transmission output (Setting range: –25.0% to 105.0%)

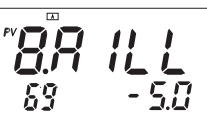
[Description]

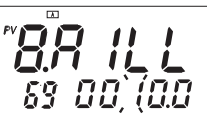
- Set the limit values of re-transmission output.
- When setting Ao2, set A2Lh and A2LL in the same way.

3. BASIC USAGE

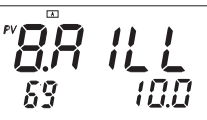
[Setting example] Changing lower limit setting of re-transmission 1 output from -5% to 10%—

Display	Operation procedure
 <p>Operation display</p>	<p>1. Check that the operation display is shown.</p>
 <p>Channel selection display</p>	<p>2. Press the [SEL] key, and the channel selection display appears, displaying <i>P51</i>.</p>
 <p>Channel selection display</p>	<p>3. Press the  key to display <i>8 SER</i>.</p>
 <p>Parameter selection display</p>	<p>4. Press the [SEL] or the  key, and <i>8.PC IF</i> appears and the parameter selection display is shown.</p>
 <p>Parameter selection display</p>	<p>5. Press the  key to display <i>8A ILL</i>.</p>
 <p>Setting change mode</p>	<p>6. Press the [SEL] or the  key to make the setting flicker, and set the value to <i>00 100</i> using the , , or the  key.</p>
 <p>Parameter selection display</p>	<p>7. Press the [SEL] key to register the setting.</p>
 <p>Operation display</p>	<p>8. Press the [DISP] key once to return to the parameter selection display. Press it again to return to the operation display.</p>

3-10 Setting communications

5Fn4 RS485 station No. (Setting range: 0 to 255)

5Pd4 RS485 communication speed (Setting range: 96, 192, 384)

biT4 RS485 bit format (Setting range: 8o, 8n, 8E)

[Description]

- Reading and writing of internal data are allowed with MODBUS RTU communications.
- See the following figure for details of parameter setting.

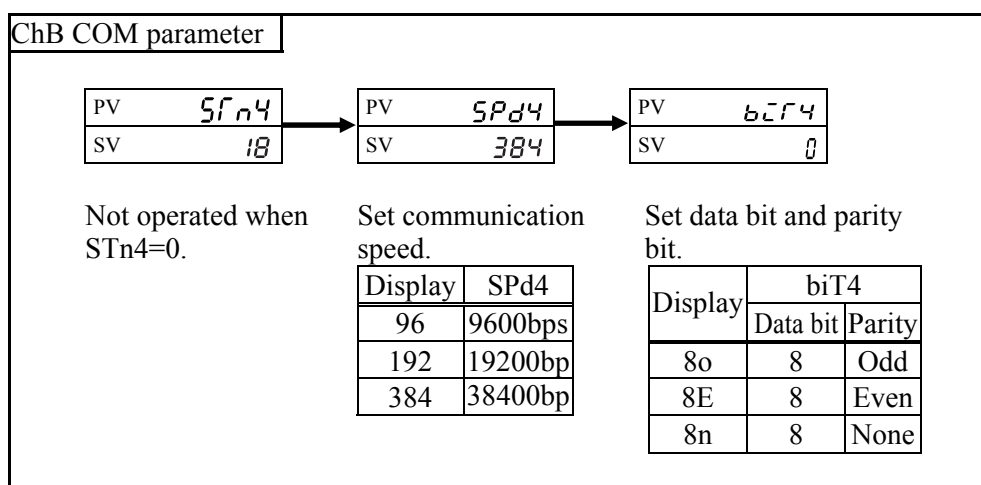











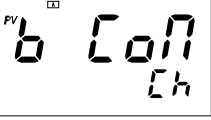

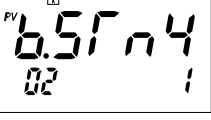

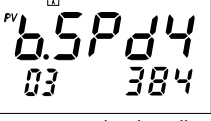
- Selected parameters are not enabled unless the power is turned on again. Be sure to reset the instrument or turn the power on again.

* See “Instruction Manual for Communication Functions (MODBUS)” for details of reading and writing of internal data and communications.

3. BASIC USAGE

[Setting example] Changing communication speed from 38400bps to 19200bps _____

Display	Operation procedure
 <p>Operation display</p>	<p>1. Check that the operation display is shown.</p>
 <p>Channel selection display</p>	<p>2. Press the [SEL] key, and the channel selection display appears, displaying <i>P51</i>.</p>
 <p>Channel selection display</p>	<p>3. Press the  key to display <i>b Conf</i>.</p>
 <p>Parameter selection display</p>	<p>4. Press the [SEL] or the  key, and <i>b57n4</i> appears and the parameter selection display is shown.</p>
 <p>Parameter selection display</p>	<p>5. Press the  key to display <i>b5Pd4</i>.</p>
 <p>Setting change mode</p>	<p>6. Press the [SEL] or the  key to make the setting flicker, and set the value to <i>192</i> using the , , or the  key.</p>
 <p>Parameter selection display</p>	<p>7. Press the [SEL] key to register the setting.</p>
 <p>Operation display</p>	<p>8. Press the [DISP] key once to return to the parameter selection display. Press it again to return to the operation display.</p>

SPd2 PC loader interface (RC232C) communication speed (Setting range: 96, 192, 384)

biT2 PC loader interface (RS232C) bit format (Setting range: 8o, 8n, 8E)





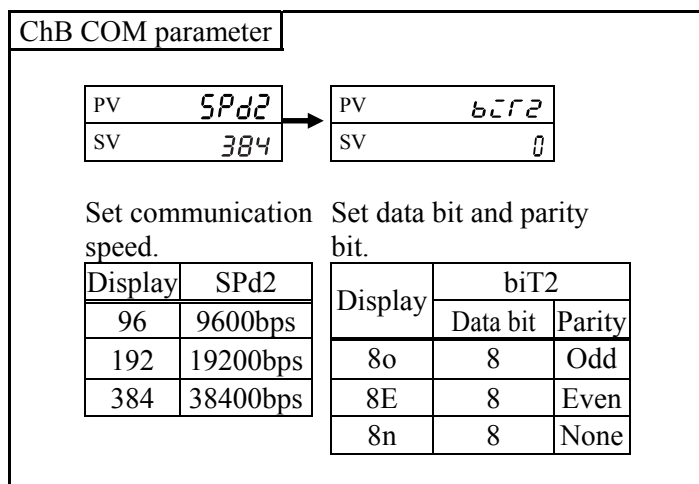







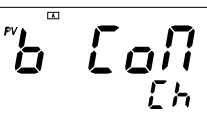

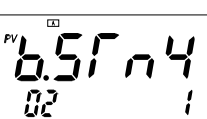
[Description]

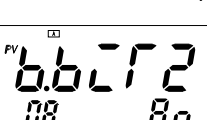
- See the following figure for details of parameter setting.

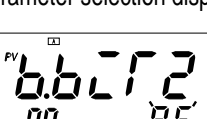

- Selected parameters are not enabled unless the power is turned on again. Be sure to reset the instrument or turn the power on again.

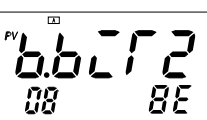
[Setting example] Setting bit format 8o to 8E

Display	Operation procedure
 <p>Operation display</p>	<p>1. Check that the operation display is shown.</p>
 <p>Channel selection display</p>	<p>2. Press the SEL key, and the channel selection display appears, displaying <i>P51</i>.</p>
 <p>Channel selection display</p>	<p>3. Press the  key to display <i>b Con</i>.</p>
 <p>Parameter selection display</p>	<p>4. Press the SEL or the  key, and <i>b.5Fn4</i> appears and the parameter selection display is shown.</p>
 <p>Parameter selection display</p>	<p>5. Press the  key to display <i>b.bCf2</i>.</p>
 <p>Setting change mode</p>	<p>6. Press the SEL or the  key to make the setting flicker, and set the value to <i>8E</i> using the , , or the  key.</p>
 <p>Parameter selection display</p>	<p>7. Press the SEL key to register the setting.</p>
 <p>Operation display</p>	<p>8. Press the DISP key once to return to the parameter selection display. Press it again to return to the operation display.</p>

4 OPERATION

Operation mode

This instrument can be operated in Auto, Remote, or Manual mode.

The operation method of each mode, operation display, and operation procedures are described below.

● Auto operation

The instrument is automatically operated with the target settings set in the controller.

Target settings can be set on the front panel or with communication.

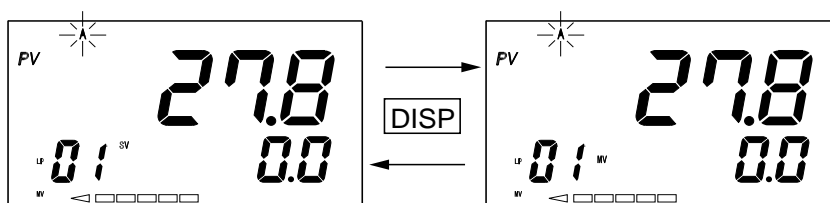

[Mode indicator]

A lights

[PV indicator]

Displays measurement value (PV).

[SV/MV indicator]

Displays set value (SV).

[SV/MV operation]

Settings can be changed on the front panel.

[Mode indicator]

A lights

[PV indicator]

Displays measurement value (PV).

[SV/MV indicator]

Displays operation output (MV).

[SV/MV operation]

Operation output cannot be changed on the front panel.

* See section 4-1 “Auto operation” for details of auto operation procedures.

● Manual operation

An operator manually changes operation output (MV) to operate the instrument.

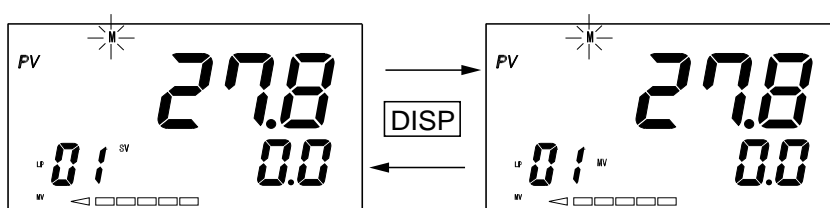

[Mode indicator]

M lights

[PV indicator]

Displays measurement value (PV).

[SV/MV indicator]

Displays set value (SV).

[SV/MV operation]

Settings can be changed in local mode.

[Mode indicator]

M lights

[PV indicator]

Displays measurement value (PV).

[SV/MV indicator]

Displays operation output (MV).

[SV/MV operation]

Settings can be changed on the front panel.

* See section 4-2 “Manual operation” for details of manual operation procedures.

4. OPERATION

● Remote operation

Operation is performed with auxiliary input Ail or the setting of SV selection (SV selectable PID controller type) used as target setting.

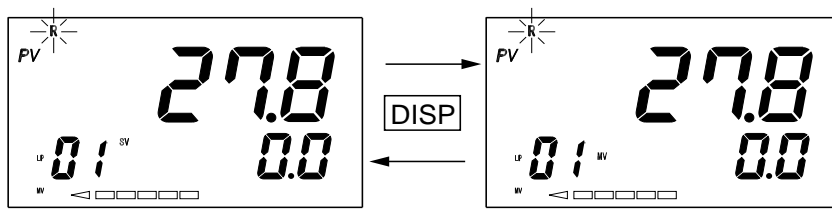

[Mode indicator]

R lights on.

[PV indicator]

Displays measurement value (PV).

[SV/MV indicator]

Displays auxiliary input Ail or target setting of SV selection PID control.

[SV/MV operation]

Target settings cannot be changed.

[Mode indicator]

R lights on.

[PV indicator]

Displays measurement value (PV).

[SV/MV indicator]

Displays operation output (MV).

[SV/MV operation]

Settings can be changed on the front panel.

* See section 4-3 “Remote operation” for details of remote operation procedures.

■ Change between Auto and Manual mode

Changing method: Operation mode can be changed between Auto and Manual using the A/M key on the operation display.

(See section 4-2 “Manual operation” for detailed operation procedures.)

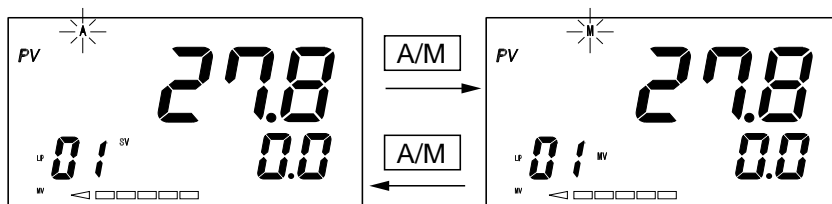

Related functions: [1] Prohibition of change to manual operation: Change to manual operation can be prohibited with A-M1 (Ch9-15) parameter. (See section 5-17 “Manual operation prohibition” for details.)

[2] Operation mode can be switched to Manual by manual command signal with Di input. (See section 5-10 “Digital input (Di) function” for details.)

Note: Change both from Auto to Manual and Manual to Auto is a balanceless bumpless transfer.

■ Changing between Auto and Remote operations

- Changing method :
- [1] Operation mode can be changed between Auto and Remote with rEM1 (Ch1-1). (See section 4-3 “Remote operation” for detailed operation procedures.)
 - [2] Operation mode can be changed between Auto and Remote by operating the dSV key. (See section 5-13 “Function key” for details.)
 - [3] The operation mode is automatically changed to Remote by performing SV switching at the time of SV selectable PID controller.
- Related functions:
- [1] Remote operation prohibition function: Remote operation can be prohibited with rihl (Ch9-7) parameter.
 - [2] Changing with R-ACK signal: The operation mode can be changed to Remote with R-ACK signal from digital input with rAC1 (Ch9-11) setting. (See section 5-16 “R-ACK function”, and section 5-10 “Digital input (Di) function “ for details.)

- Note:
- | | |
|------------------------------|---|
| Change from Remote to Local: | Provision of tracking function can be selected with Trk1 (Ch9-23).
Balanceless bumpless transfer when TrK1=On
Balance bumpless transfer when TrK1=Off |
| Change from Local to Remote: | Balance bumpless transfer
(Balance remote SV and local SV while watching dSV display before changing modes.) |

Flow of operation mode change

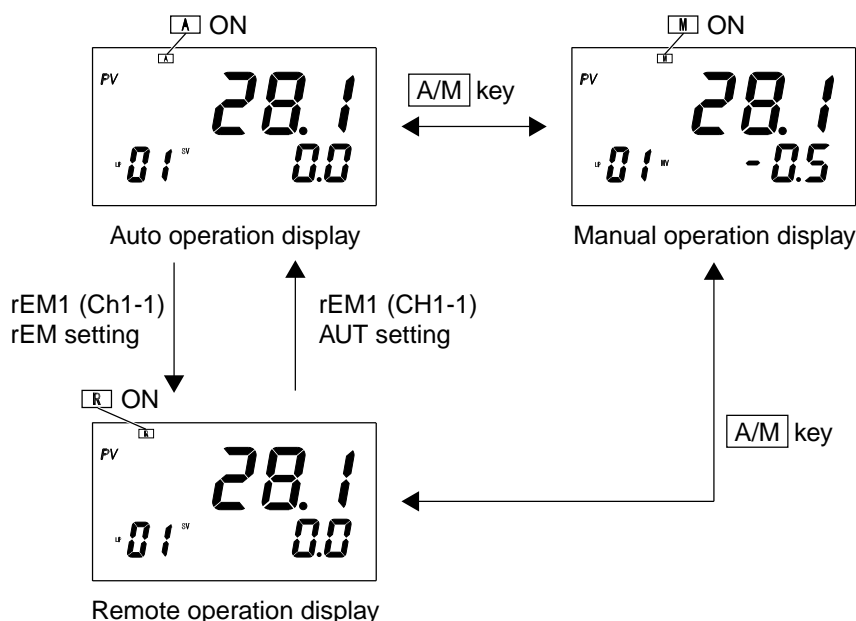

4-1 Auto operation









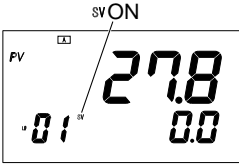

[Description]

Set value (SV) can be set on the front panel, and the result of PID operation can be output as operation output (MV), which is called “Auto operation.”

The **[A]** lamp is kept on during auto operation.

The SV during auto operation is called “Local SV”.

Changing SV

Display	Operation procedure
 <p>Operation display</p>	<p>— Changing SV —</p> <ol style="list-style-type: none"> 1. Check that the “SV” of the SV/MV lamp lights on the operation display.
	<ol style="list-style-type: none"> 2. Press the  key, and the value of the digit at the far right increases. Press the  key, and the value of the digit at the far right decreases. The SV value is immediately reflected in this case.
 <p>Setting change mode</p>	<ol style="list-style-type: none"> 3. Press the  key, and the digit at the far right of the SV starts flickering. Press the  key again while it is flickering, and you can move to the digit you want to change.
	<ol style="list-style-type: none"> 4. When the digit you want to change being flickering, change the setting by pressing the  and  keys.
 <p>Operation display</p>	<ol style="list-style-type: none"> 5. Press the [SEL] key, and the change of SV is completed, and the setting is reflected.

Displaying operation output (MV)

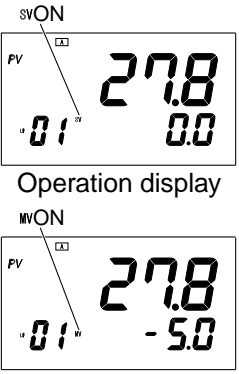
Display	Operation procedure
 <p>Operation display</p>	<p>—Displaying MV —</p> <ol style="list-style-type: none"> 1. Check that the “SV” of the SV/MV lamp lights on the operation display. 2. Press the DISP key while the “SV” lamp is on, and the display changes to MV display. (“MV” lamp comes on.) (Press the DISP key again to return to the SV display operation screen.)

Changing from Auto (A) operation to Manual (M) operation

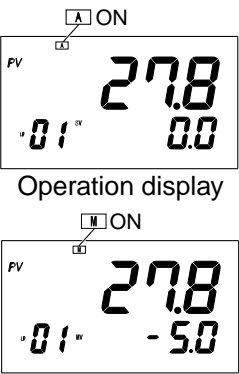
Display	Operation procedure
 <p>Operation display</p>	<ol style="list-style-type: none"> 1. Check that the A lamp lights on the operation display. 2. Press the A/M key while the A lamp is on, and the M lamp comes on, and the operation mode is changed to Manual. (Press the A/M key to return to Auto operation.)

Note: The operation output (MV) value immediately before the change to Manual operation is displayed when operation mode is changed from Auto to Manual.
The MV value is kept output until the MV setting is changed.

4-2 Manual operation

[Description]

Operation output (MV) can be directly operated by an operator, which is called “Manual operation.” (Setting unit is %.)

The M lamp lights is on during manual operation.

Displaying operation output (MV)

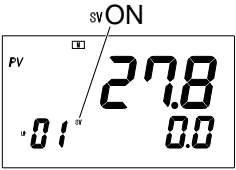
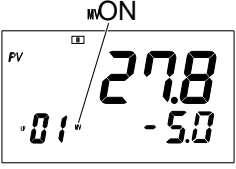
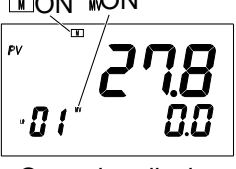
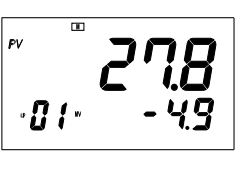
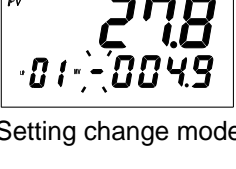
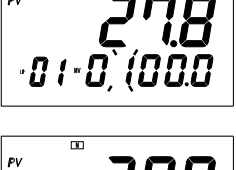
Display	Operation procedure
 <p>Operation display</p>	<p>—Displaying MV—</p> <ol style="list-style-type: none"> 1. Check that “SV” of the SV/MV lamp lights on the operation display. 2. Press the <input type="checkbox"/> DISP key while the “SV” lamp is kept on, and the display changes to MV display. (Press the <input type="checkbox"/> DISP key again to return to the SV display screen.)
 <p>Operation display</p>	<p>—Changing MV—</p> <ol style="list-style-type: none"> 1. Check that the “MV” lamp and <input type="checkbox"/> M lamp lights on the operation display.
 <p>Operation display</p>	<ol style="list-style-type: none"> 2. Press the <input type="checkbox"/> ▲ key, and the value of the digit at the far right increases. Press the <input type="checkbox"/> ▼ key, and the value of the digit at the far right decreases. The MV value is immediately reflected in this case. Pressing the <input type="checkbox"/> ▲ key or the <input type="checkbox"/> ▼ key for 3 seconds accelerates the increase or the decrease.
 <p>Setting change mode</p>	<ol style="list-style-type: none"> 3. Press the <input type="checkbox"/> ► key, and the digit at the far right of the MV value starts flickering. Press the <input type="checkbox"/> ► key again while it is flickering, and you can move to the digit you want to change.
	<ol style="list-style-type: none"> 4. When flickering moves to the digit you want to change, change the setting by pressing the <input type="checkbox"/> ▲ and the <input type="checkbox"/> ▼ keys.
 <p>Operation display</p>	<ol style="list-style-type: none"> 5. Press the <input type="checkbox"/> SEL key, and the change of MV is completed, and the setting is reflected.

Changing from Manual (M) to Auto (A) operation

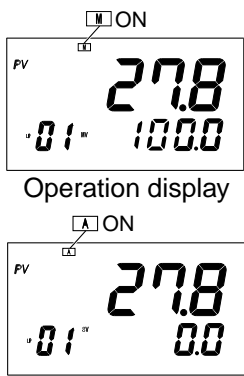
Display	Operation procedure
 <p>The top screenshot shows the display with 'PV' on the left, '27.8' in the center, and '01' and '1000' at the bottom. A small box labeled 'M' is lit, and a larger box labeled 'ON' is also lit. Below the display is the text 'Operation display'.</p> <p>The bottom screenshot shows the same display, but the 'A' lamp is now flickering, and the 'ON' box is no longer lit. Below the display is the text 'Operation display'.</p>	<ol style="list-style-type: none"> 1. Check that the <input type="checkbox"/> M lamp lights on the operation display. 2. Press the <input type="checkbox"/> A/M key while the <input type="checkbox"/> M lamp is kept on, and the <input type="checkbox"/> A lamp starts flickering and the operation mode is changed to Auto. (Press the <input type="checkbox"/> A/M key again to return to Manual operation.)

4-3 Remote operation (SV=Auxiliary input Ai1)

REN1 Changing Remote/Auto operation (Setting range: REM, AUT)

[Description]

This instrument can be operated either in “Auto operation” mode, in which SV is set using the keys on the front panel, or “Remote operation” mode, in which SV is set with external settings (remote SV) set by analog auxiliary input signals or SV selection method (see section 4-4 “SV selection function (Remote operation)”). Change to Remote operation mode can also be made using the Function key allocated by users, or Di remote acknowledge signals (R-ACK) besides using this parameter.

This parameter cannot be used for SV selection method.

* See section 5-16 for details of R-ACK function.

* See section 5-13 for details of Function keys.

To operate the instrument in Remote mode (SV=Auxiliary input Ai1), set the control template (TPLT (Ch8-92)) to “10”, “13” or “16” in advance.







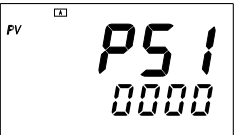
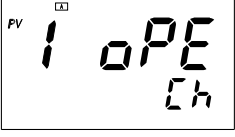

Note: Remote operation can be performed only when “1” is selected for the 7th digit of the code symbols.

• To perform Remote operation

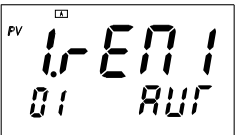
- (1) Set Ai1F, Ai1B, and Ai1D (Ch8-40, 41, 42) to the same value as PV1F, PV1B, and PV1D (Ch8-1, 2, 3) (If PV1 input scale setting and Ai1 input scale setting do not coincide, the value of Ai1 monitor (Ch7-4) and remote SV are not the same.)
- (2) Set Ai1T (Ch8-43) to the voltage range to be input.
- (3) Connect the voltage signal for remote SV to the auxiliary input terminal (Ai1).
- (4) Perform zero point adjustment and span point adjustment of remote SV input as required.
 - Ai1Z (Ch8-45): Parameter for zero point adjustment of remote SV input
 - Ai1S (Ch8-46): Parameter for span point adjustment of remote SV input
 - (See section 5-9 “User adjustment” for details.)
- (5) Change REM1 (Ch1-1) parameter from AUT to REM, and the mode is changed to Remote SV operation mode.
 - (Change can also be made by the Function key or Di.)

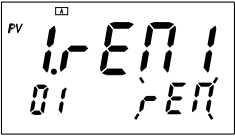
* A1TF (Ch8-50) is the setting for remote SV input filter. Keep the setting to 0.0 (factory-set value) unless the change is inevitable.

[Setting example] Changing operation mode from Auto to Remote

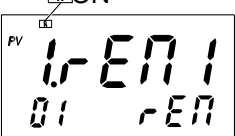
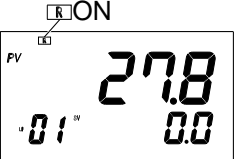
Display	Operation procedure
 <p>Operation display</p>	<p>1. Check that the operation display is shown.</p>
 <p>Setting change mode</p>	<p>2. Press the SEL key, and the channel selection display appears, displaying <i>P51</i>.</p>
 <p>Setting change mode</p>	<p>3. Press the  key to display <i>1 oPE</i>.</p>
 <p>Parameter selection display</p>	<p>4. Press the SEL or the  key, and the parameter selection display appears, displaying <i>1-EN1</i>.</p>
 <p>Setting change mode</p>	<p>5. Press the SEL or the  key to make the setting flicker, and set the value to <i>rEN</i> using the  or the  key.</p>
 <p>Parameter selection display</p>	<p>6. Press the SEL key to register the setting.</p>
 <p>Operation display</p>	<p>7. Press the DISP key once to return to the parameter selection display. Press it again to return to the operation display.</p>

[Note]

For changing operation mode from Remote to Auto

- Follow the same procedure to change this parameter from REM to AUT.
- See section 5-19 “SV tracking function” for the SV when the operation mode is changed from Remote to Auto.

4-4 SV selection function (Remote operation)

- Eight kinds of set values (SV), SV1 to 7 of Ch3 (PLT) and local SV, can be selected and controlled with Di1 to 3, which is called SV selection function.
- Set TPLT (Ch8-92) to “11” or “14” to use the SV selection function.
- Select SV, referring to the following table.

SV No.	Di1	Di2	Di3
SV (Local set value)	OFF	OFF	OFF
SV1 (Remote SV)	ON	OFF	OFF
SV2 (Remote SV)	OFF	ON	OFF
SV3 (Remote SV)	ON	ON	OFF
SV4 (Remote SV)	OFF	OFF	ON
SV5 (Remote SV)	ON	OFF	ON
SV6 (Remote SV)	OFF	ON	ON
SV7 (Remote SV)	ON	ON	ON

[Note]

Operation is carried out in Remote mode when SV1 to 7 is selected.

[Example]

Set SV1 (Ch3-1) to 50.0, SV2 (Ch3-12) to 60.0, and SV3 (Ch3-23) to 40.0, and the operation can be performed according to the settings of SV1 (for 0 to t_1), SV2 (for t_1 to t_2) and SV3 (for t_2 to t_3).

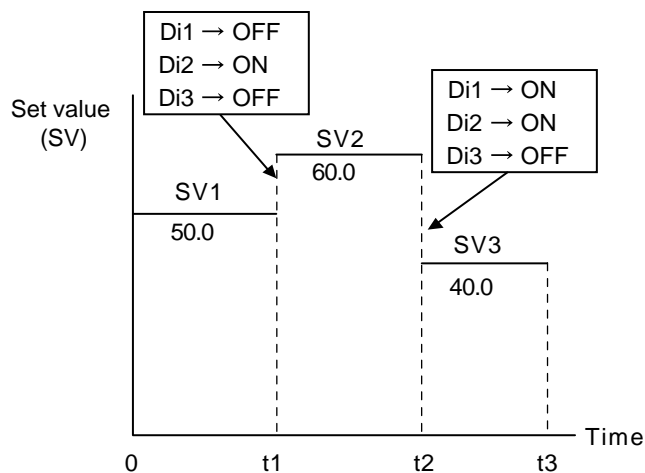

Setting range	-25.0 to 125.0%FS (Engineering value setting depend on full scale) (Within the range of the SV limiter if it is set.)
Factory-set value	0.0%FS (Engineering value setting depend on full scale)

- See section 5-19 “SV tracking function” for the SV when the operation mode is changed from Remote to Auto.

4-5 Standby function

STBY Standby setting (Setting range: ON, OFF)

STbo Operation setting for standby function (Setting range: 0, 1)

PMV1 Output setting for standby function (Setting range: -25.0 to 105.0%)

[Description]

1) Change between RUN/Standby with STby (Ch1-5).

During standby state, all the outputs except for control output (MV) and communication are turned OFF. Control output (MV) becomes designated value.

- The **STBY** lamp is kept on during standby.
(PV and SV display can be turned off with STbo (Ch9-30) setting.)
- See the following table for the status of functions during standby.

	During standby	Return from standby
Operation output	Outputs value designated by PMV1.	Bumpless restart from PMV1.
Alarm output	All outputs are OFF.	—
Timer operation	All operations are OFF.	Zero start
Hold operation	-	Initial start
Latch operation	All operations are OFF.	Initial start (released)
Non-excitation output operation	All outputs are OFF. (Non-excitation operations are invalid)	Work in non-excitation operation
Communication	Not affected by standby status.	
Analog re-transmission output	0mA	
Digital output (Do)	All outputs are OFF.	—
Digital input (Di)	—	Status detection: Operated Edge detection: Not operated.
Control mode	Not affected by standby status.	
Display	Can be selected from ON/OFF	ON

- Standby setting is maintained even if the power is turned ON/OFF.
- If the instrument is put into standby while auto tuning is carried out, the auto tuning is canceled. PID constant is not updated.

2) Set the operations during standby to STbo.

- See the following table for the operations during standby.

STBY	STbo setting	Operation during standby		
		MV output	Output other than MV	Display
ON	0	Value of PMV1 (Ch2-22) (-25% to 125%)	OFF or -25%	ON
	1	Value of PMV1 (Ch2-22) (-25% to 125%)	OFF or -25%	OFF
OFF	—	Normal operation	Normal operation	ON

4. OPERATION

3) Set the output value (MV) during standby to PMV1 (Ch2-22).

This value is output during standby.

On setting standby to OFF, the operation value (MV) restarts in bumplessly.

Example: When PMv1 (Ch2-22) is set to 100.0

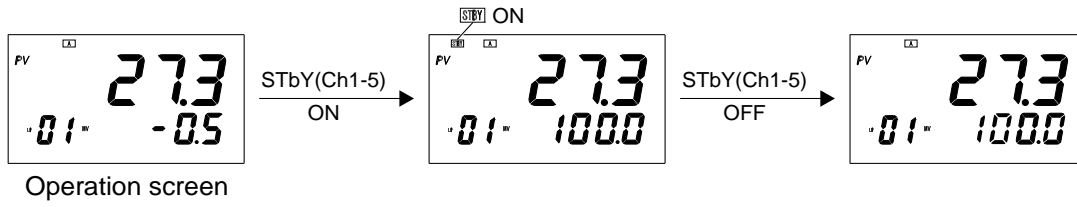

4-6 How to use monitoring function

- Monitoring: Input/output value can be checked with the monitoring function.
- The monitor exists in Ch7 (Mon). See the appended parameter list.

1) Di and Do are displayed as shown below.

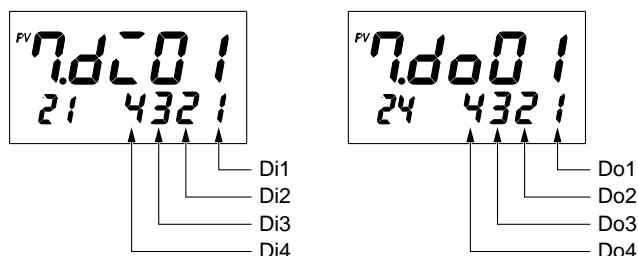

When the value is kept on: ON
When the value is kept off: OFF

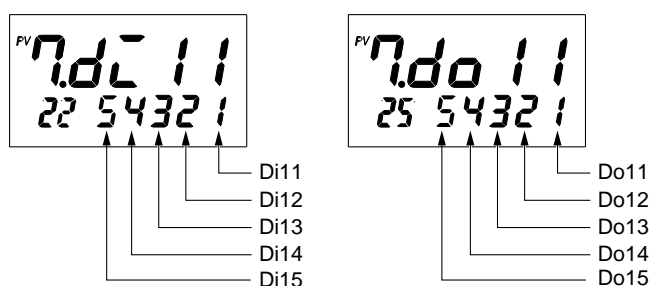

When the value is kept on: ON
When the value is kept off: OFF

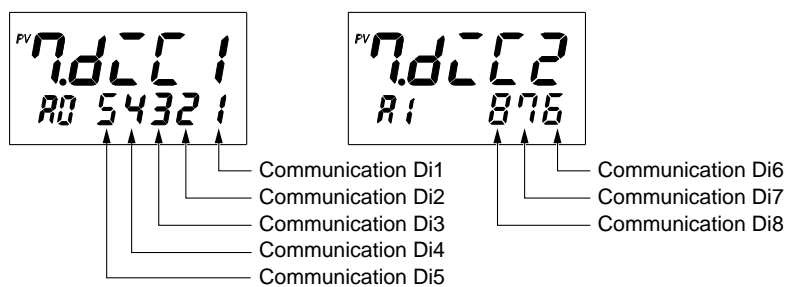

When display stays on: ON
When display stays off: OFF

- 2) Ao1 and Ao2, are in unit of %.
- 3) The unit for TM1 to 8 is changed between seconds and minutes according to the alarm option setting.

[Note]

Contents in monitors cannot be changed.

5 ADVANCED USAGE

5-1 Setting inputs

P1CU PV1 input square-root extractor cut point (Setting range: OFF, 0.0 to 125.0%)

P1TF PV1 input filter time constant (Setting range: 0.0 to 900.0 seconds)

[Description]

1) P1CU(Ch8-11)

Square root extraction

- To convert differential pressure to flow rate, use square root extraction.
Where differential pressure is small, the flow rate to the set router cut point is handled as “0” to prevent the flow rate from being changed greatly and becoming unstable by noise.

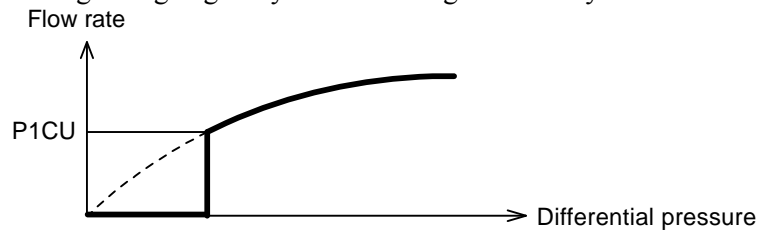

- To use square root extraction for PV2 and Ai1, make the setting for P2CU (Ch8-24) and A1CU (Ch8-49) in the same way.

2) P1TF (Ch8-12)

Input filter

Fluctuation of measurement value by noise, etc. can be suppressed by input filter.

When the value of P1 (Ch2-1) (proportional band) is small, even a small change of PV makes the MV value fluctuate greatly. Control can be stabilized by filtering in such cases.

This instrument's filter is a first-order lag filter.

If the input filter time constant P1TF is set to 5.0, the PV display gradually changes when input is suddenly changed from 0 to 100% as shown by the following figure, and it takes 5 seconds for the value to change from 0 to 63.2%.

The larger the value of the filter time constant, the stronger the effect of the filter.

Small←	Time constant→	Large
Fast←	Response→	Slow
Weak←	Effect→	Strong

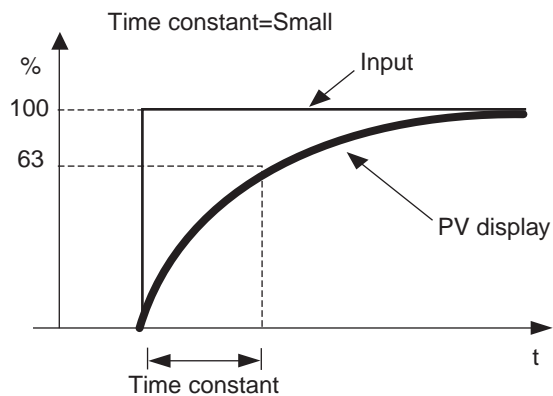
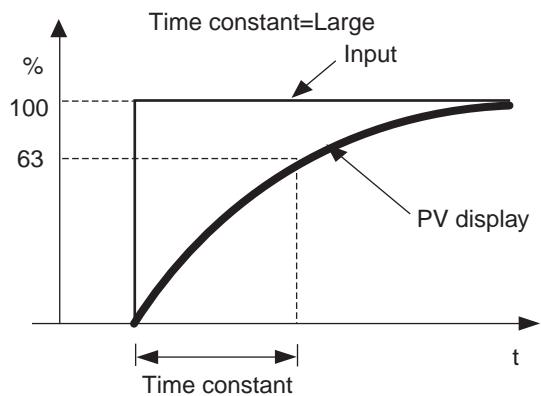

To use the filter for PV2 and Ai1, make the setting for P2TF (Ch8-25) and A1TF (Ch8-50) in the same way.

5-2 Setting output

Ld1 Output limiter type setting (Setting range: 0 to 3)

Mvh1 Upper limit value of operation output (MV) (Setting range: -25.0 to 125.0%FS))

MvL1 Lower limit value of operation output (MV) (Setting range: -25.0 to 125.0%FS))

dMv1 Limit value of MV change rate (Setting range: 0.0 to 150.0%)

[Description]

1) Ld1 (Ch2-38)

- It can be set whether the value should be limited at the output limit setting or the limit should be exceeded (scale out) when the operation output (MV) value reaches the output limit setting.

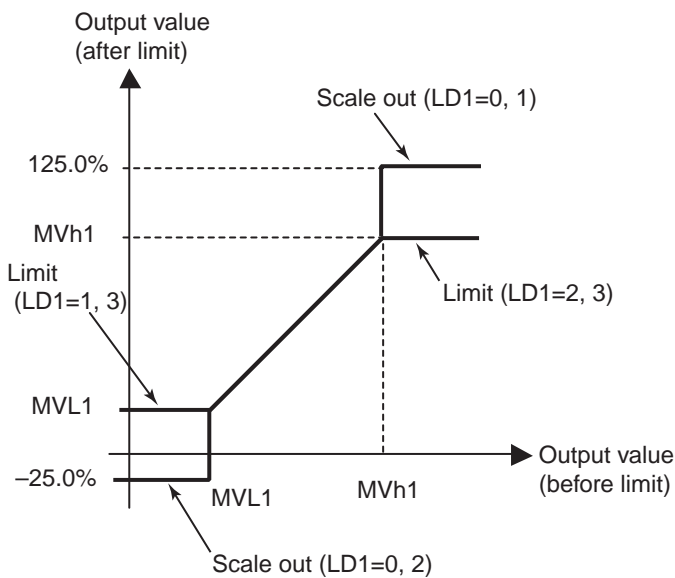

LD1 setting	Output operation	
	Upper side	Lower side
0	Scale out (125.0%)	Scale out (-25%)
1	Scale out (125.0%)	Limit (MvL1)
2	Limit (Mvh1)	Scale out (-25%)
3	Limit (Mvh1)	Limit (MvL1)

2) Mvh1 (Ch2-9), MvL1 (Ch2-10)

- Set the limit value or scale out point of the operation output (MV).

[Note]

- Neither upper/lower limit nor scale out does not occur in the following cases.
 - During manual operation
 - During standby
 - During EXMV output
 - During burnout
- Ld1 (Ch2-38), Mvh1 (Ch2-9), MvL1 (Ch2-10) output settings are enabled during auto tuning.
- If MV is limited, P and I operations in the direction in which MV deviates from the limit are cut off.

3) dMV1 (Ch2-13)

- Limit value for the change of MV in 1 control cycle (50msec) can be set.
- Setting 0.0 provides no limit.
- Operation output (MV) set manually during manual operation is also limited.

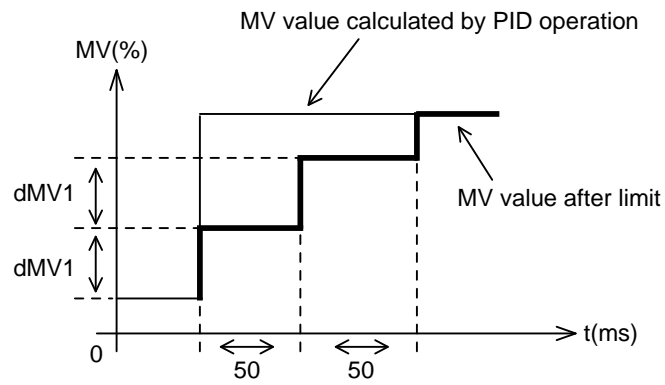

5-3 Setting PID

- | | |
|-------------|--|
| P I | Proportional band (Setting range: 0.0 to 999.9%) |
| i I | Integral time (Setting range: 0.0 to 3200.0sec) |
| d I | Derivative time (Setting range: 0.0 to 999.9sec) |
| dT I | PID operation cycle setting (Setting range: 5 to 1000) |

[Description]

1) P1 (Ch2-1)

[Setting method]

- Setting can be made automatically by auto tuning.
- To set manually, select optimum value in the proportional band with this parameter.

[ON/OFF control]

- Set P1 to 0.0 to perform ON/OFF control (2-position control).
- Hysteresis of ON/OFF control can be set with hS1 (Ch2-15).

[Note]

- Generally, if too small a value is set to P (proportional band), the control becomes unstable. If too large a value is set, on the contrary, the reaction becomes slow.
- The instrument is placed under PID control (P≠0) mode, if auto tuning is performed. If the instrument should be operated with ON/OFF control, do not perform auto tuning.

2) i1 (Ch2-2)

[Setting method]

- Setting can be made automatically by auto tuning.
- To set manually, select optimum integral time with this parameter.

[Positional P operation]

- If i1 is set to 0.0, integral action is not carried out. Positional P operation is performed instead.

[Note]

- If P1 is set to values other than 0, i1 setting is made invalid.

3) d1 (Ch2-3)

[Setting method]

- Setting can be made automatically by auto tuning.
- To set manually, select optimum derivative time with this parameter.

[Note]

- If d1 is set to 0.0, derivative action is not carried out.
- If P1 is set to 0, d1 setting is made invalid.

4) dT1 (Ch2-14)

- Set the cycle of performing control operation (PID operation).

[Note]

- Setting can be made in the unit of 10ms, but operation cycle is changed in the unit of 50ms.
- (Setting example)
 - When dT1=5 to 9, control operation cycle is 50ms.
 - When dT1=10 to 14, control operation cycle is 100ms.

5-4 .Setting hysteresis

hS1 Hysteresis width at the time of 2-position operation (Setting range: 0 to 50%FS)

[Description]

1) hS1 (Ch2-15)

- To perform ON/OFF control (2-position operation control), set P1 (Ch2-1) to 0.0. i1 (Ch2-2) or d1 (ch2-3) need not be set.
- If the hysteresis width (width of ON/OFF control) is made small, output may be repetitively turned ON/OFF frequently. (In the case of contact output, in particular, the service life of the relay and the operation device may be shortened.)
- The unit of the setting of this parameter is engineering value, but the settable range varies depending on the measurement range of the input.

[Example] Input K Thermocouple: When measurement range is 0 to 400°C,
Settable range is 0 to 200°C.
Resistance bulb: When measurement range is 0 to 150°C,
Settable range is 0 to 75°C.

Example of parameter setting and operation

1) Reverse action

Parameter	Set value
P1 (Ch2-1)	0.0
hS1 (Ch2-15)	Arbitrary
rEv1 (Ch2-20)	REV

Relation between PV and SV	Output
$PV > SV$	OFF
$PV < SV$	ON

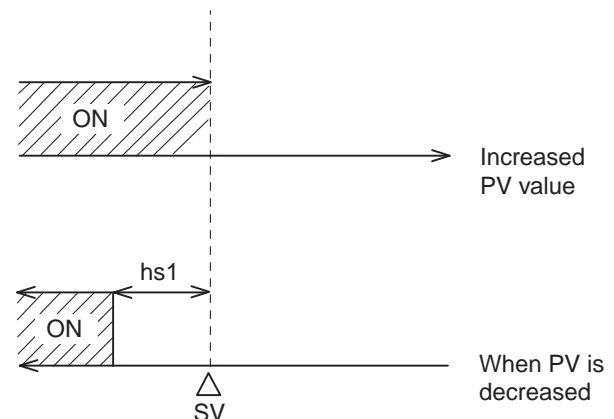

2) Normal (direct) action

Parameter	Set value
P1 (Ch2-1)	0.0
hS1 (Ch2-15)	Arbitrary
rEv1 (Ch2-20)	NRML

Relation between PV and SV	Output
$PV > SV$	ON
$PV < SV$	OFF

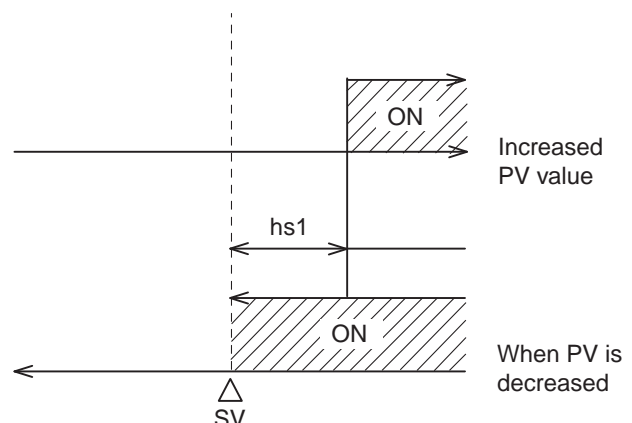

5-5 Setting bAL, Arh, and ArL

bAL 1 Output convergence value (Setting range: -100.0 to 100.0%)

Arh 1 Integration upper cut point (Setting range: 0 to 100%FS)

ArL 1 Integration lower cut point (Setting range: 0 to 100%FS)

[Description]

1) bAL1 (Ch2-18)

- In the case of I=0 (positional P operation)
The value of bAL (Ch2-18) is added as offset to the result of PID operation performed with PV and SV, which is regarded as output (MV).

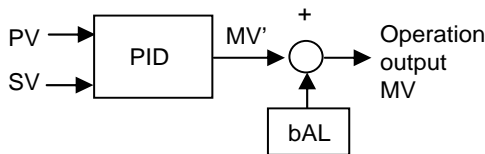

- In the case of PID operation (I≠0)
The value set to bAL becomes the operation output value at the time of power ON.

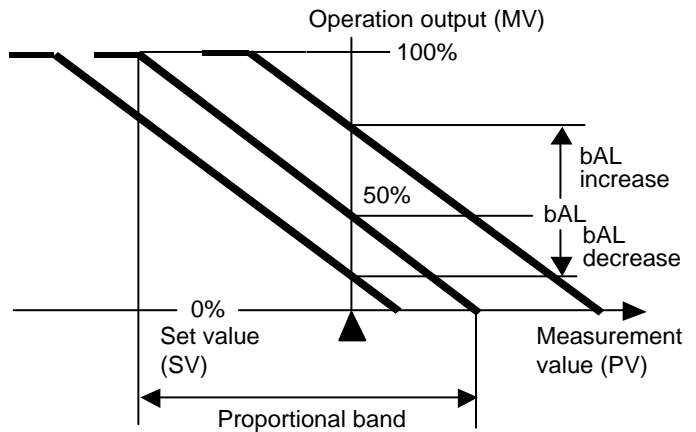

2) Arh1 (Ch2-5), ArL1 (Ch2-6)

- The range where integral action is performed is limited.
- Integration is performed within the range $SV - ArL \leq PV \leq SV + Arh$.
- Integral action is not carried out outside the range.
- If integral action is included in the control operation, overshoot occurs due to initial excessive integration. To prevent this, the range where integral action is performed is limited.

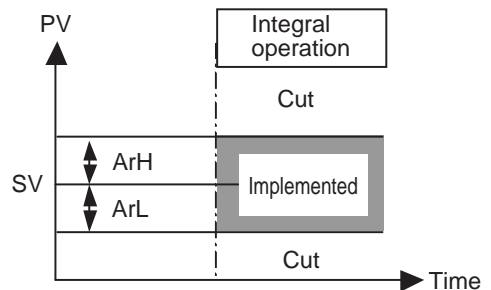

[Note]

- Arh1 (Ch2-5), ArL1 (Ch2-6) and bAL (Ch2-18) are not automatically set by auto tuning.

5-6 Palette function

PLTn Palette selection (Setting range: 0 to 7)

PLTS Palette switching method setting (Setting range: PLTn, SV, PV)

[Description]

This instrument is provided with 7 groups of control palettes (group of control parameters) at Ch3 (PLT), in addition to control parameter at Ch2 (PID). Control can be made while switching these control palettes. Select control palette switching method with PLTS parameter.

1) PLTS (Ch9-31)

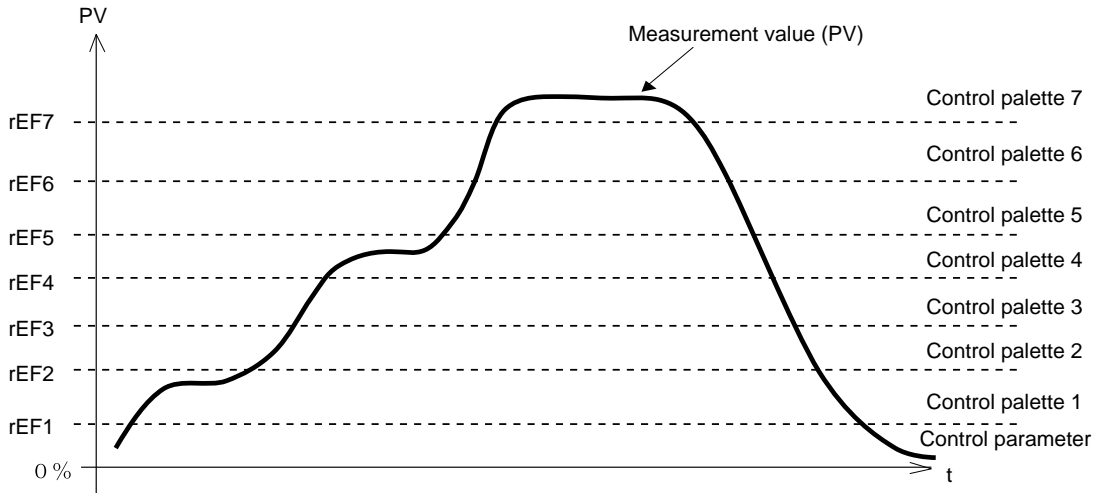
PLTS setting	Control palette switching method
PLT n	Operation is performed with the control palette set at PLTn (Ch1-9). The SV of the control palette being selected becomes the current target set value.
SV	This is effective when SV selectable type PID control (TPLT=11 or 14) is used. Operation is performed with the control palette of the SV No. selected by Di. See section 3-1 “Setting control template” for details of SV selection type PID control.
PV	Operation is performed while control palettes are automatically switched depending on the measurement value (PV), with the value set for rEF1 to rEF7 (Ch3-78 to 84) regarded as threshold. The following figure shows the relation between the PV reference point and the control palettes. 

2) PLTn (Ch1-9)

- When PLTS is set to PLTn, set the No. of control palette used for operation.
- When PLTS is set to SV or PV, No. of control palette currently used for operation is displayed. PLTn parameter cannot be set in this case.

[Note]

- 1) Before using the palette function, be sure to set rEF1, and rEF7.
- 2) Set as rEF1 < rEF2, ... < rEF7.
(Unless the above is met, settings will be ignored.)

5-7 Key lock

LoC Key lock setting (Setting range: 0 to 5)

[Description]

1) LoC (Ch1-34)

- Key lock is the function of preventing parameters and set values (SV) from being changed. Note that if the key lock function is made valid, parameters and set values can be displayed.
- Set LoC (Ch1-34) to 0 to reset the key lock function.
- Control operation and alarm operation are performed normally even if the key lock function is made valid.
- The setting of key lock function can be made in the following 6 stages.

LoC	Key operation		Via communication	
	All parameters	Set value (SV)	All parameters	Set value (SV)
0	○	○	○	○
1	X	X	○	○
2	X	○	○	○
3	○	○	X	X
4	X	X	X	X
5	X	○	X	X

○:Setting allowed X:Setting not allowed

5-8 Setting output direction at the input error burnout

brd1 Burnout direction setting (Setting range: HOLD, LO, UP, EXMV)

[Description]

1) brd1(Ch9-35)

- Set the value of operation output (MV) at the time of input error. Output value can be selected from the following 4 types.

brd1	Operation output (MV) at the time of input error
hold	Value of operation output (MV) immediately before burnout
LO	-25%
UP	125%
EX-MV	EXM1 (Ch2-97) setting

- * See section 5-22 “EX-MV function” for details of EXM1 setting.

Error display

Display	Cause
UUUU	1) Burnout of thermocouple sensor 2) Burnout of resistance bulb 3) PV reading exceeds upper limit value +5%FS. 4) RCJ module is not mounted (thermocouple input).
LLLL	1) LLLL display appears for a moment when resistance bulb sensor (line B) breaks.

- If even one of the inputs related to mathematical expressions (PV1, PV2, Ai1) burns out when Math function (TPLT (Ch8-92)=10, 11 or 16) is performed, the main unit is brought into burnout state.

- * See section 5-14 for details of Math function.
- * See section 3-1 for details of control templates.

5-9 User adjustment

PV 12 Zero adjustment value setting of PV1 input (Setting range: -50% to 50%)

PV 15 Span adjustment value setting of PV1 input (Setting range: -50% to 50%)

[Description]

PV1Z (Ch8-6), PV1S (Ch8-7)

- User calibration function is independent of the adjusted value of the controller main unit. If 0 is set to this parameter, factory-set status can be restored.
- 1) Before starting calibration using this parameter, provide the following devices.
 - Generator
 - 1 to 5V (For voltage input)
 - 0 to 100mV (For thermocouple)
 - 0 to 100mA (For current input)
 - Dial resistor
 - 100.0 to 400.0Ω (For resistance bulb input)
 - 2) Apply input equivalent to 0%.
 - If the error is out of permissive range, set PV1Z (Ch8-6).
 - (See the following example for setting method.)
 - 3) Apply input equivalent to 100%.
 - If the error is out of permissive range, set PV1S (Ch8-7).
 - (See the following example for setting method.)

[Example of adjustment for input range of 0 to 400°C]

Before adjustment	Adjusted value	After adjustment
Reading at 0°C input: -1°C	PV1Z: 1	Reading at 0°C input: 0°C
Reading at 400°C input: 402°C	PV1S: -2	Reading at 400°C input: 400°C

If 0 is set both to PV1Z and PV1S parameters, factory-set calibration status is restored.

[Note]

- Check the value of each input with monitoring parameters in Ch7 (MON).
To adjust thermocouple input, set parameter rCJ1 to OFF before performing operation in [item 2)] above, and when the operation in [item 3)] above is completed, set it to ON again.
See section 5-21 “Parameter mask” for procedure of displaying parameter rCJ.

[
rCJ1 display mask=20-6
]
[
rCJ2 display mask=21-6
]

- To use it as input offset, set the same value to PV1Z and PV1S. The shift is made by the set value.
- To adjust PV2, set PV2Z (Ch8-19) and PV2S (Ch8-20).
To adjust Ai1, set Ai1Z (Ch8-45) and Ai1S (Ch8-46).

5-10 Digital input (Di) function

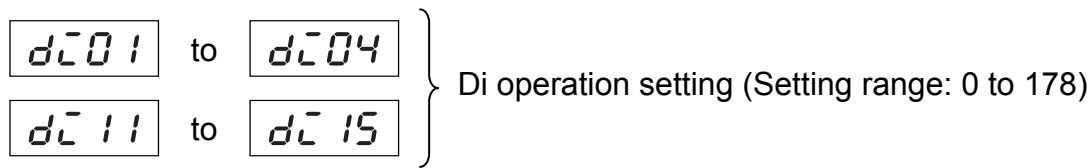

[Description]

di01 (Ch9-39) to di04 (Ch9-42)

di11 (Ch9-43) to di15 (Ch9-47) [only for 9 digital input point model.]

Select each Di function with Di setting parameter, and set Di to ON to operate.

Di1 to Di15 setting	Function	Operation Conditions			
		Status detection		Edge detection	
		ON	OFF	ON	OFF
0	None	-	-	-	-
1	STBY (standby)	Standby	RUN	-	-
30	AT (Auto tuning)	-	-	AT start	AT stop
40	Alarm latch reset (Alarm 1) to (Alarm 8) Release all	-	-	Release all	Latch hold
50 to 57	Timer operation (Alarm 1) to (Alarm 8)	ON	OFF	-	-
60	R-ACK (Remote acknowledge)	Remote	Local	-	-
70	SMV (Manual command)	Manual mode	Auto mode	-	-
80	PV-TRK command (PV tracking)	ON	OFF	-	-
103	EX-MV (External output value)	EX-MV	MV	-	-
140	Switching of the active expression for Math function	Hi selector expression	Lo selector expression	-	-
160	Totalizer start/stop, reset	HOLD	RUN	-	-
161		LATCH	RUN	-	-
162		Reset	-	-	-
170	Ramp/soak OFF	-	-	OFF	-
171	Ramp/soak RUN/HOLD	-	-	RUN	HOLD
172	Ramp/soak RUN	-	-	RUN	-
173	Ramp/soak HOLD	-	-	HOLD	-
174	Ramp/soak activation pattern No. +1	+1	-	-	-
175	Ramp/soak activation pattern No. +2	+2	-	-	-
176	Ramp/soak activation pattern No. +4	+4	-	-	-
177	Ramp/soak activation pattern No. +8	+8	-	-	-
178	Ramp/soak activation pattern No. +16	+16	-	-	-

1) Switching between control RUN and Standby (Di setting=1)

- Switching can be done between control RUN and Standby with Di.
ON: Standby
OFF: RUN

5. ADVANCED USAGE

2) Auto tuning start (AT) (Di setting=30)

- Switching can be done between Start and Stop of auto tuning.

Auto tuning type	Di	
	$\overline{\uparrow}$ ON	$\overline{\downarrow}$ OFF
Normal type (NRML)	AT start	AT stop
Low PV type (LPV)		

* Type of auto tuning (NRML, LPV) is selected with ATP1 (ChE-1) beforehand.

3) Alarm latch reset (Di setting=40)

- The latched alarm can be released with this function.

Di setting	Di	
	ON	OFF
40	Latch release (all alarms)	Latch hold

4) Timer operation (Di setting=50 to 57)

- When the code is set to 36 to 38 with alarm type setting, timer ON/OFF can be selected. See section 3-8 "Alarm function" for details of timer operation.

ON: Timer operation ON, OFF: Timer operation OFF

Di Setting	Timer operation
50	ALM1
51	ALM2
52	ALM3
53	ALM4
54	ALM5
55	ALM6
56	ALM7
57	ALM8

5) R-ACK (Remote acknowledge) (Di setting=60)

- Changeover between Auto and Remote can be done with Di.
- To use this function, set TPLT (Ch8-92) to 10, 13 or 16, rAC1 (Ch9-11) to EnA, and rEM1 (Ch1-1) to rEM.

[Example: Di1 is allocated to this function]

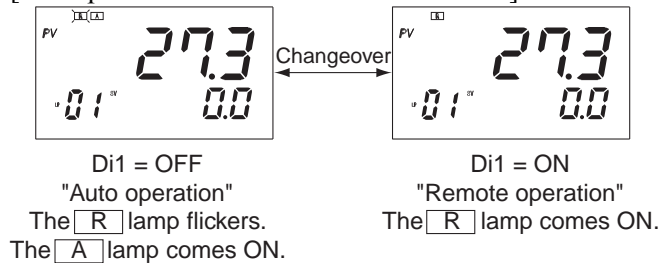

- After changing TPLT (Ch8-92) setting, be sure to reset the instrument or turn the power on again.
- See section 5-16 for details of R-ACK (remote acknowledge).

6) SMV (Manual command) (Di setting=70)

- Changeover between Auto and Manual operation can be done with Di.
- To use this function, set TPLT (Ch8-92) to 10, 13, 16.

[Example: Di2 is allocated to this function]

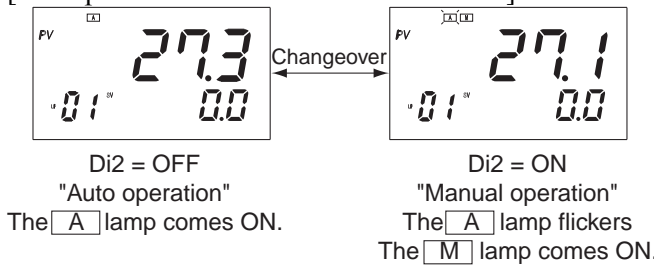

* After changing TPLT (Ch8-92) setting, be sure to reset the instrument or turn the power on again.

7) PV tracking (Di setting=80)

- SV value can be tracked to PV value.
- Select one Di from Di 1 to 4 or Di 11 to 15, and set it to “80.”
- Set the selected Di to ON or OFF to perform switching.

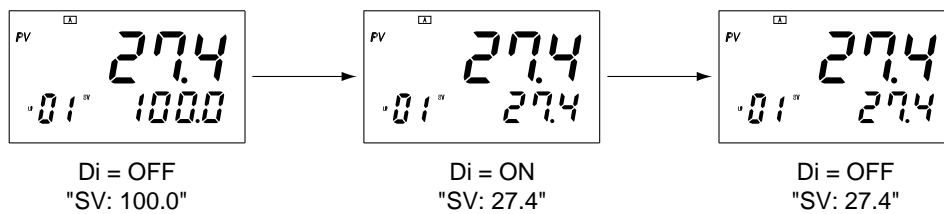

8) EX-MV (Di setting=103)

- Switching between MV (operation output) and EX-MV (external output) can be done with Di.
- Set Di to OFF to select MV, and set it to ON to select EX-MV.

When EXM1 (Ch2-97) is set to 60.0

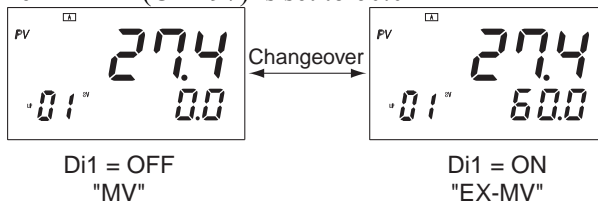

* See section 5-22 “EX-MV function” for details.

9) Switching the active expression for Math function. (Di setting: 140)

- Di input is used as a selector switch between Lo selector/Hi selector expressions in the case of CALC (Ch8-88) is set as follows.

CALC setting	Name of operation	Di input	
		OFF	ON
12	H/L selector, 2 points	Lo selector	Hi selector
13	H/L selector, 3 points	Lo selector	Hi selector
32	H/L selector, 2 points (with coefficient)	Lo selector	Hi selector
33	H/L selector, 3 points (with coefficient)	Lo selector	Hi selector

10) Totalizer RUN/HOLD and LATCH (Di setting=160, 161)

Di setting	Di input	
	OFF	ON
160	RUN	HOLD
161	RUN	LATCH

* See “RUN/HOLD/LATCH” in section 5-25 “Totalizer function” for details.

5. ADVANCED USAGE

11) Totalizer RESET (Di setting=162)

Di setting	Di input	
	OFF	ON
162	–	RESET

* See “Totalize RESET” in section 5-25 “Totalizer function” for details.

12) Ramp/soak

Switches the Ramp/soak operation and specify the activation pattern.

DI setting value	Di	
	OFF	ON
170	–	Ramp/soak OFF
171	Ramp/soak HOLD	Ramp/soak RUN
172	–	Ramp/soak RUN
173	–	Ramp/soak HOLD
174	–	Ramp/soak activation pattern No. +1
175	–	Ramp/soak activation pattern No. +2
176	–	Ramp/soak activation pattern No. +4
177	–	Ramp/soak activation pattern No. +8
178	–	Ramp/soak activation pattern No. +16

[Note]

- Please refer to "5-30 Ramp/Soak" regarding the Ramp/soak function.

5-11 Digital output (Do) function

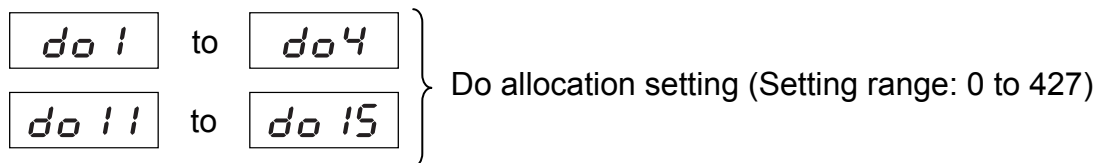

[Description]

- 1) **do1 (Ch9-53) to do4(Ch9-56)**
do11 (Ch9-57) to do15 (Ch9-61) [only for 9 digital output point model]

- Select signals to be output to digital output (Do).
- Do keeps output even if the input value becomes error (ex. UUUU, LLLL).
- If OTYP (Ch8-93) is set to 11 or 13, and MV is allocated, priority is given to MV.

See the following table for the setting.

Do Setting	Output signal
0	No setting
1	ALM1
2	ALM2
3	ALM3
4	ALM4
5	ALM5
6	ALM6
7	ALM7
8	ALM8
17	OR of ALMs
29	System fault
41	Totalizer ALM1
42	Totalizer ALM2
80	Manual MV (status)
81	EX-MV command (status)
82	Remote SV (status)
83	Local SV (status)
84	PV tracking (status)
85	Normal (Direct) action (status)
86	Auto tuning (AT) (status)
87	Remote request (status)
88	Remote acknowledge (R-ACK) (status)
89	Not-Auto (status)
90	Mode OR output 1
91	Mode OR output 2
160	Ramp/soak OFF
161	Ramp/soak RUN
162	Ramp/soak HOLD
163	Ramp/soak GS
164	Ramp/soak END
...	
170	Time signal (1st segment)
171	Time signal (2nd segment)
...	Time signal (3rd to 126th segment)

*1

*2

5. ADVANCED USAGE

Do Setting	Output signal
296	Time signal (127th segment)
297	Time signal (128th segment)
...	
300	Relative time signal (1st segment)
301	Relative time signal (2nd segment)
...	Relative time signal (3rd to 126th segment)
426	Relative time signal (127th segment)
427	Relative time signal (128th segment)

*1) Contents of OR operation: Manual + Auto

*2) Contents of OR operation: Manual + EX-MV

5-12 Setting LED allocation

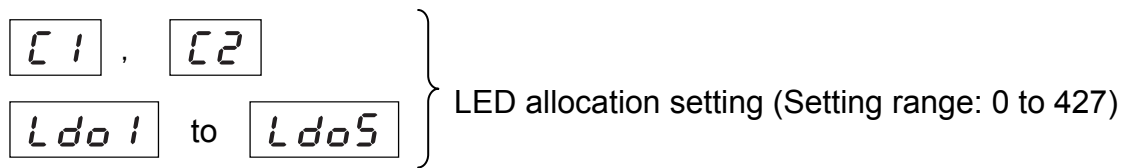

[Description]

- 1) C1 (Ch9-67), C2 (Ch9-68)
Ldo1 (Ch9-69) to Ldo5 (Ch9 to 73)

- Make the setting to change signals to be output to the lamp on the front face.
- See the following table for the setting.

C1, C2 Ldo1 to Ldo5	Type	
0	No setting	
1	ALM1	
2	ALM2	
3	ALM3	
4	ALM4	
5	ALM5	
6	ALM6	
7	ALM7	
8	ALM8	
17	OR of ALMs	
21	Output (MV) 1	*3
22	Output (MV) 2	*3
29	System fault	
41	Totalizer ALM1	
42	Totalizer ALM2	
80	Manual MV (status)	
81	EX-MV command (status)	
82	Remote SV (status)	
83	Local SV (status)	
84	PV tracking (status)	
85	Normal (Direct) action (status)	
86	Auto tuning (AT) (status)	
87	Remote request (status)	
88	Remote acknowledge (R-ACK) (Status)	
89	Not-Auto (status)	
90	Mode OR output 1	*1
91	Mode OR output 2	*2
160	Ramp/soak OFF	
161	Ramp/soak RUN	
162	Ramp/soak HOLD	
163	Ramp/soak GS	
164	Ramp/soak END	
...		
170	Time signal (1st segment)	
171	Time signal (2nd segment)	
...	Time signal (3rd to 126th segment)	

5. ADVANCED USAGE

C1, C2 Ldo1 to Ldo5	Type
296	Time signal (127th segment)
297	Time signal (128th segment)
...	
300	Relative time signal (1st segment)
301	Relative time signal (2nd segment)
...	Relative time signal (3rd to 126th segment)
426	Relative time signal (127th segment)
427	Relative time signal (128th segment)

*1) Contents of OR operation: Manual + Auto

*2) Contents of OR operation: Manual + EX-MV

*3) The lamp does not come ON for current (4 to 20mA) output type.

5-13 Function key

F1 to **F3** Function key allocation setting (Setting range: 0 to 72)

[Description]

F1 (Ch9-32) to F3 (Ch9-34)

- Functions listed in the following table can be allocated to the F1, F2, and the F3 keys. The F1, F2, and the F3 keys are collectively called referred to as F key.

F key setting (Function key code)	Key operation
0	No function
1	dSV display Changeover between Remote and Auto (Press for 2 seconds.) Note 1
2	Standby/RUN changeover
3	Alarm latch reset
10	AT (Auto tuning) START/STOP
20	Timer operation start/stop (ALM 1)
21	Timer operation start/stop (ALM 2)
22	Timer operation start/stop (ALM 3)
23	Timer operation start/stop (ALM 4)
24	Timer operation start/stop (ALM 5)
25	Timer operation start/stop (ALM 6)
26	Timer operation start/stop (ALM 7)
27	Timer operation start/stop (ALM 8)
30	Totalizer RUN/HOLD
31	Totalizer RUN/LATCH
32	Totalizer RESET
41	Transfer of SV1 to local SV
42	Transfer of SV2 to local SV
43	Transfer of SV3 to local SV
44	Transfer of SV4 to local SV
45	Transfer of SV5 to local SV
46	Transfer of SV6 to local SV
47	Transfer of SV7 to local SV
50	Selection of palette 0
51	Selection of palette 1
52	Selection of palette 2
53	Selection of palette 3
54	Selection of palette 4
55	Selection of palette 5
56	Selection of palette 6
57	Selection of palette 7
60	Parameter jump 1
61	Parameter jump 2
62	Parameter jump 3
70	Change over the "RUN/OFF" of Ramp/soak
71	Change over the "RUN/HOLD" of Ramp/soak
72	Send pattern No.+1

5. ADVANCED USAGE

Note 1: Do not use this setting when TPLT (Ch8-92) is set to 11 or 14.

1) dSV display Remote/Auto changeover (Function key code=1)

Press the F key once. : By pressing the F key once on the operation display, the dSV display and the PV/SV operation display (or PV/MV operation display) can be displayed alternately.

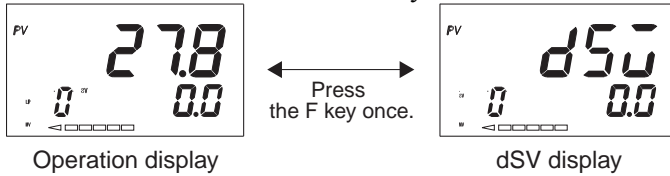

Note: Switching between the operation display and the dSV display can be done both in Auto and Remote operation modes.

• Press the F key for 2 seconds. : By pressing the F key for 2 seconds on the operation display, changeover between Remote and Auto operations is executed.

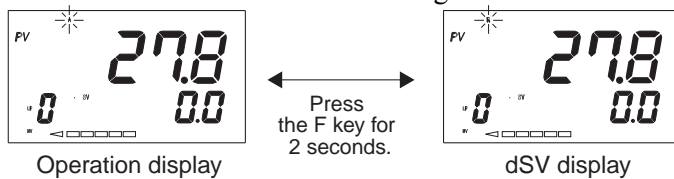

• How to use the dSV display

Use the dSV display to balance the Remote SV and the Local SV when switching operation mode from Auto to Remote.

(When operation is switched from Remote to Auto, the set value (SV) is automatically balanced, which is SV tracking function.)

$$\text{dSV} = \text{Local SV} - \text{Remote SV}$$

[Example of use]

Operation mode = Auto

Local SV = 50.0°C

Remote SV = 200.0°C

dSV = -150.0°C (=50.0°C - 200.0°C) is displayed.

Procedure 1: Press the F key once to show the dSV display.

Procedure 2: Using the \blacktriangleright , \blacktriangle , and the \blacktriangledown key, change the value of dsv from -150.0 to 0.0.
(When dSV is set 0.0, the Local SV becomes equal to the Remote SV.)

Procedure 3: Press the F key for 2 seconds to switch operation from Auto to Remote.

(The controller is operated with the Remote SV (externally set signal) regarded as target set value.)

[Note]

- If the operation cannot be switched from Auto to Remote by following the procedures shown above, check rAC (Ch9-11) parameter. See section 5-16 "Remote acknowledge (R-ACK) function" for details of rAC parameter.
- If the set value (SV) cannot be automatically balanced when operation is switched from Remote to Auto, check Trk1 (Ch9-23) parameter.
See section 5-19 "SV tracking function" for details of Trk1 parameter.

- 2) Standby/RUN changeover (Function key code=2)
- Control can be switched between RUN and Standby with the F key.
 - Press the F key for 1 second to switch.

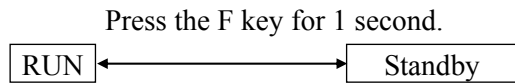

* See section 4-5 for details of standby function.

- 3) Alarm latch reset (Function key code=3)
- The latched alarm can be released with this function.

- 4) Auto tuning (AT) (Function key code=10)
- Auto tuning start and stop can be switched.

Type of auto tuning	F key	↔	F key
Standard Low PV	AT start		AT stop

* See section 3-7 “AT (Auto tuning)” for details.

- 5) Timer operation (Function key code=20 to 27)
- When alarm type code is set to 36 to 38 with alarm function, timer ON/OFF can be selected. See section 3-8 “Alarm function” for details of timer operation.

- 6) Totalizer START/HOLD/LATCH and RESET operation (Function key code = 30 to 32)

Use this function to perform totalizer operation control.

The following functions can be allocated to function keys.

Function key	Function	Note
30	RUN / HOLD	Every time the function key is pressed
31	RUN / LATCH	Every time the function key is pressed
32	RESET	Press the function key for 1 second

- 7) Local SV switching (Function key code = 41 to 47)
- The settings for palettes 1 to 7, SV1 to SV7, can be used as Local SV.
 - Press the F key for 1 second to make.
 - Switching can be made only when PV/SV is displayed on the operation screen.
 - * This function is available even when operation is performed in SV selectable controller.
 - * This function is available even when Remote operation is performed.
 - (1) Operation is performed with switched SV at the time of R → A, if SV tracking function is OFF.
 - (2) Operation is performed with Remote SV at the time of R → A, if SV tracking function is ON.

- 8) Palette number selection (Function key code = 50 to 57)
- Use this function to switch palette numbers (PLTn parameter).
 - Palette number 0 means Local PID control parameters. (Ch2 Pid)
 - Palette numbers 1 to 7 mean control palettes. (Ch3 PLT)
 - Press the F key for 1 second to make.
 - Switching can be made only when PV/SV is displayed on the operation screen.

5. ADVANCED USAGE

9) Parameter jump (Function key code = 60 to 62)

- Use the function to jump to set parameters specified beforehand.
- The destination of the jump is the parameter set in “JP parameter setting.”
- Press the key once to jump to the specified parameter.
- Jump can also be made on the operation, parameter display, and monitor screens.

Function key	Function	Parameter for setting destination of jump
60	Parameter jump 1	JP1 (Ch1-35)
61	Parameter jump 2	JP2 (Ch1-36)
62	Parameter jump 3	JP3 (Ch1-37)

See “JP parameter setting” on the next page for details of jump destination parameter setting.

- * “PAS1” is displayed if a maked parameter or channel is specified and the F key is pressed.
- * Even if the F key is pressed while parameter setting is performed, jump to a parameter does not occur.

10) Ramp/soak

- When Ramp/soak operation setting is set, following can be used.
- Following functions can be allocated to the function key.

Function key	Function	Note
70	RUN/OFF	Everytime press the function key, Ramp/soak RUN/OFF will be changed over.
71	RUN/HOLD	Everytime press the function key, Ramp/soak RUN/HOLD will be changed over.
72	Current Ramp/soak activation pattern +1	Sends the Ramp/soak pattern №+ 1

Note: Ramp/soak activtaion pattern chaged over by function key "72" will be changed over by pattern selection Max. and Min. setting (PTnM,PMin)
Please refer to "5-30 Ramp/Soak" concerning pattern selection Max. and Min. setting.

JP 1 to **JP 3** JP parameter setting (Setting range: 1-01 to z-z9)

[Description]

JP1 (Ch1-35), JP2 (Ch1-36), JP3 (Ch1-37)

- Enabled when parameter jump function is allocated to function keys
The parameter to which the jump is to be made can be set.
See the following table for the function key setting and parameters to which, jump is to be made.

JP parameter	Function key setting
JP1 (Ch1-35)	60
JP2 (Ch1-36)	61
JP3 (Ch1-37)	62

1) JP parameter setting method

Parameters can be allocated as JP parameters as follows.

Use channels and parameter numbers to make parameter setting.

[Example] When allocating alarm 1 setting AL1 (ch1-10) to F1 key to make a jump

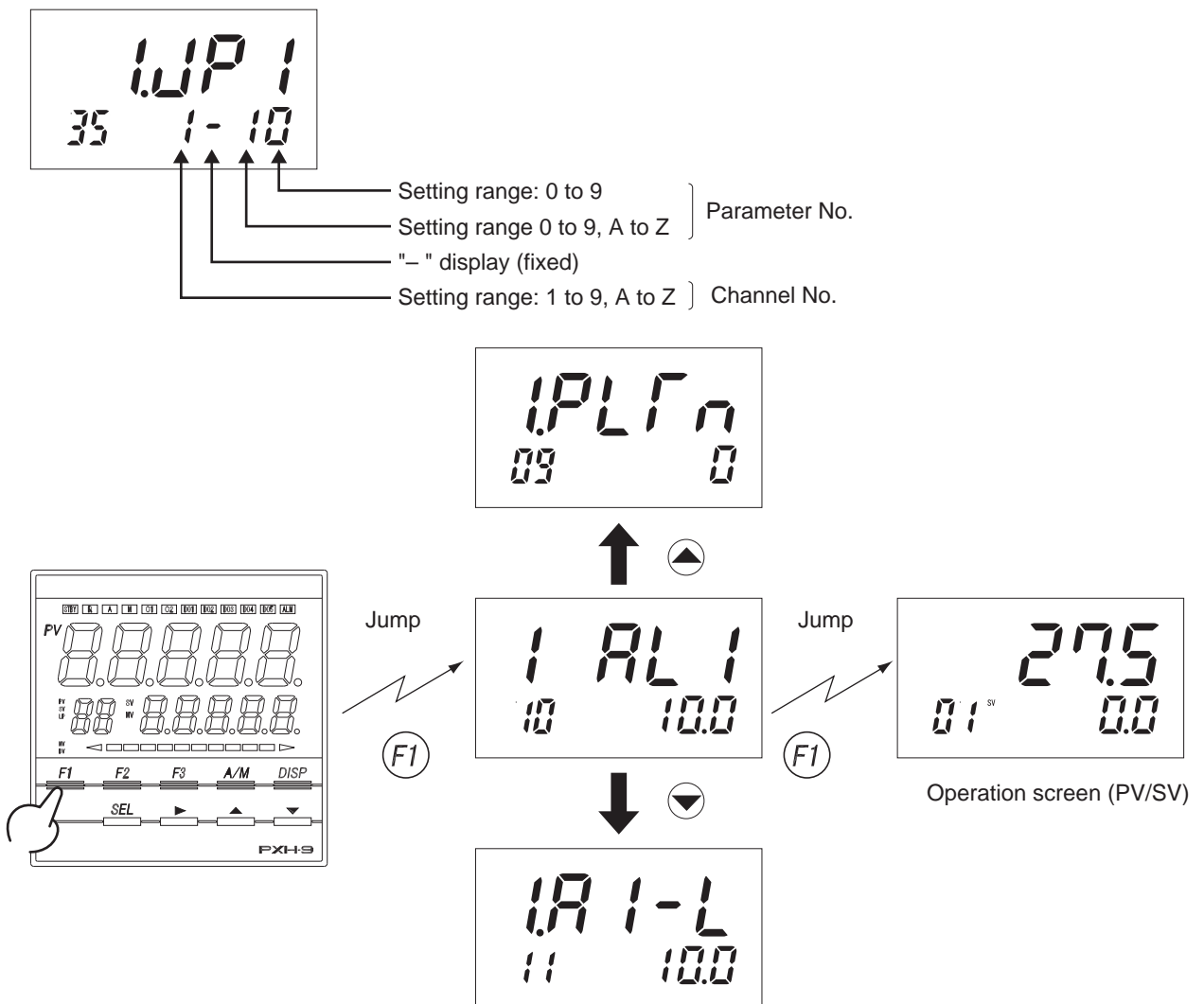

* After a jump is made, transfer between parameters and setting can be made as usual.

5-14 Math function

- CALC Math function type setting (Setting range: 0 to 40)
 - UCF 1 Scale of Math function on the full side
 - UCb 1 Scale of Math function on the base side
 - UCd 1 Decimal point position of Math function (Setting range: 0 to 3)
 - t 0 1 to t 1 6 The constant for expression (Setting range: -9999 to 99999)
- } (Setting range: -19999 to 99999)

[Description]

What is Math function?

By substituting arbitrary values into input value (PV1, PV2, Ai1) and constant (k01 (ChD-1) to k16 (ChD-16)), the result of operation M1 can be used as PV, which is called Math function. (See the following figure.)

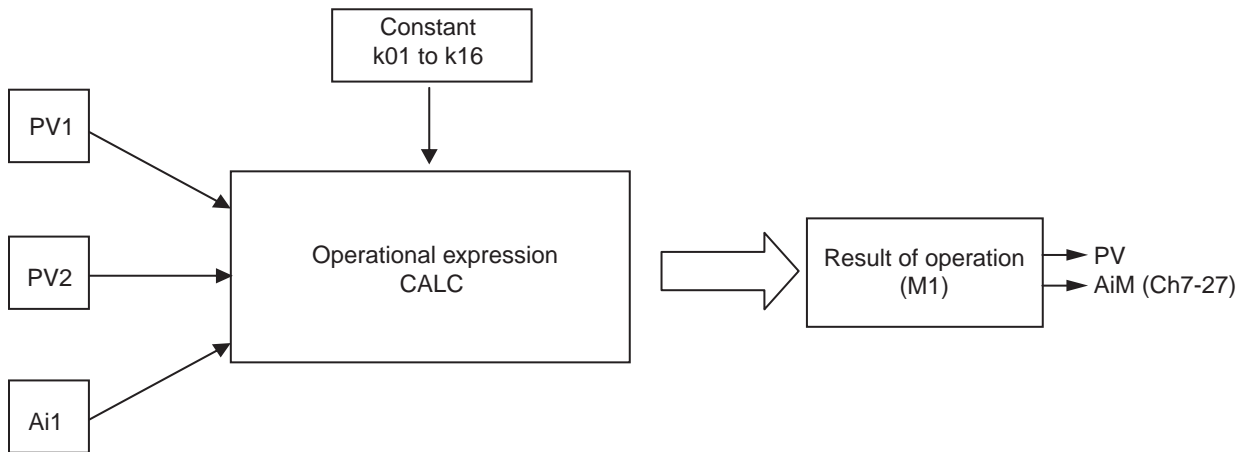

Set the control template TPLT (Ch8-92) to 10, 11 or 16 to use Math function.

[IMPORTANT]

In the case of using the result of operation (M1) as PV, the scale of PID operation (i.e. Full Scale) is defined with UCF1, UCb1, and UCd1.

1) CALC (Ch8-88)

- Select the type of arithmetic expressions.
- There are 24 types of arithmetic expressions. (See the following table.)

CALC setting	Name of operation	Arithmetic expression
0	No math operation	M1 = PV1 input
1	Mathematical expression 1 (Flow rate compensation with temperature and pressure)	$M1 = k01 \times \sqrt[1]{PV1} \times \sqrt[2]{\frac{Ai1 + k02}{k03}} \times \frac{k04}{PV2 + k05}$ PV1: Flow rate (differential pressure), PV2: Temperature, Ai1: Pressure
2	Mathematical expression 2 (Flow rate compensation with temperature and pressure)	$M1 = k01 \times PV1 \times \sqrt[1]{\frac{Ai1 + k02}{k03}} \times \frac{k04}{PV2 + k05}$ PV1: Flow rate (differential pressure), PV2: Temperature, Ai1: Pressure
3	Mathematical expression 3 (Flow rate compensation with temperature and pressure)	$M1 = k01 \times PV1 \times \frac{Ai1 + k02}{k03} \times \frac{k04}{PV2 + k05}$ PV1: Flow rate (differential pressure), PV2: Temperature, Ai1: Pressure
4	Mathematical expression 4	$M1 = \frac{(k01 \times (k02 \times PV1 + k03 \times PV2 + k04 \times Ai1) + k05)}{(k06 \times (k07 \times PV1 + k08 \times PV2 + k09 \times Ai1) + k10)}$
5	Mathematical expression 5	$M1 = \frac{(k01 \times ((k02 \times PV1 + k03) \times (k04 \times PV2 + k05) \times (k06 \times Ai1 + k07)) + k08)}{(k09 \times ((k10 \times PV1 + k11) \times (k12 \times PV2 + k13) \times (k14 \times Ai1 + k15)) + k16)}$
6	Mathematical expression 6	$M1 = k01 \times PV1 \times (k02 \times PV2 + k03 \times Ai1) + k04 \times Ai1 + k05$
7	H selector (2 points)	M1 = Max (PV1, PV2) PV1 or PV2, whichever is larger, is selected.
8	L selector (2 points)	M1 = Min (PV1, PV2) PV1 or PV2, whichever is smaller, is selected.
9	H selector (3 points)	M1 = Max (PV1, PV2, Ai1) PV1, PV2, or Ai1, whichever is largest, is selected.
10	L selector (3 points)	M1 = Min (PV1, PV2, Ai1) PV1, PV2, or Ai1, whichever is smallest, is selected.
11	Input switching (2 points)	M1 = PV1 when $PV1 \leq k01$, M1 = PV2 when $PV1 > k01$
12	H/L selector (2 points) (with Di switching function)	Expression 7 or 8 is used by Di switching. (Specify "140" for Di function for switching.)
13	H/L selector (3 points) (with Di switching function)	Expression 9 or 10 is used by Di switching. (Specify "140" for Di function for switching.)
20	Flow rate compensation with temperature and pressure [% value operation]	$M1 = \sqrt{PV1 \frac{(Ai1 + k01) + k02}{(PV2 \times k03) + k04}}$ PV1: Differential pressure (flow rate) % value, k01: Pressure compensation constant 1, k04: Temperature compensation constant 2 PV2: Fluid temperature % value, k03: Temperature compensation constant 1 Ai1: Differential pressure % value, k02: Pressure compensation constant 2, k05: Square-root extractor cut point *Input data: % value (0 (0%) to 100000 (100.000%))
21	Flow rate compensation with temperature and pressure [% value operation] (without square-root extraction)	$M1 = PV1 \frac{(Ai1 \times k01) + k02}{(PV2 \times k03) + k04}$ All the inputs and constants are of the same specifications as mathematical expression 20.
27	H selector (2 points) (with coefficient)	$M1 = \max((PV1 \times k01 + k02), (PV2 \times k03 + k04))$
28	L selector (2 points) (with coefficient)	$M1 = \min((PV1 \times k01 + k02), (PV2 \times k03 + k04))$
29	H selector (3 points) (with coefficient)	$M1 = \max((PV1 \times k01 + k02), (PV2 \times k03 + k04), (Ai \times k05 + k06))$
30	L selector (3 points) (with coefficient)	$M1 = \min((PV1 \times k01 + k02), (PV2 \times k03 + k04), (Ai \times k05 + k06))$
31	Input switching (2 points) (with coefficient)	M1 = (PV1 X k02 + k03) when $k01 > (PV1 \times k02 + k03)$ M1 = (PV2 X k04 + k05) when $k01 \leq (PV1 \times k02 + k03)$
32	H/L selector (2 points) (with Di switching function)	Expression 27 or 28 is used by Di switching. (Specify "140" for Di function for switching.)
33	H/L selector (3 points) (with Di switching function)	Expression 29 or 30 is used by Di switching. (Specify "140" for Di function for switching.)
34	Input switching (2 points) (with coefficient and interpolation function)	When $PV1 \leq k05$: $M1 = (PV1 \times k01) + k02$ When $PV2 \leq k06$: $M1 = (PV2 \times k03) + k04$ When $PV1 > k05$ and $PV2 < k06$: Interpolation shown below, is executed. $M1 = \left(1 - \frac{(PV1 \times k01 + k02) - k05}{k06 - k05}\right) \times (PV1 \times k01 + k02) - k05 - \left(\frac{(PV1 \times k01 + k02) - k05}{k06 - k05}\right) \times (PV2 \times k03 + k04)$ * note) k05: Input switching upper value k06: Input switching lower value
40	Calorie calculation	$M1 = ((PV1 \times k01 + k02) - (PV2 \times k03 + k04)) \times (Ai1 \times k05 + k06)$

*1: Square-root extraction cut point can be set with k06.

*2: Square-root extraction cut point can be set with k07.

5. ADVANCED USAGE

2) UCF1 (Ch8-89)

UCb1 (Ch8-90)

- The scale of the full side (upper limit) and the base side (lower limit) of the result of operation used for control operation can be set. This scale becomes the scale of PID operation.

3) UCd1 (Ch8-91)

- Select the decimal point position of the result of Math operation.

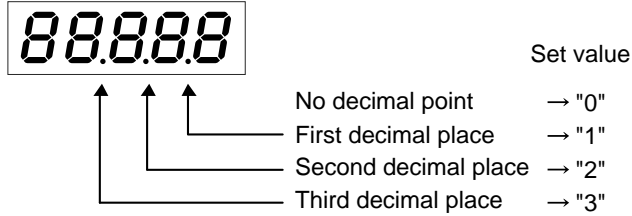

If CALC (CH8-88) is set to 0 (no operation) when TPLT is set to 10, 11 or 16, PV1 becomes the result of operation, and the scale used for PID operation becomes UCF1 (Ch8-89), UCB1 (Ch8-90) and UCD1 (Ch8-91).

4) k01 (Chd-1) to k16 (Chd-16)

- Substitute proper values into constant k01 (Chd-1) to k16 (Chd-16).

[Setting method]

Setting method of constant is different from the method of setting other parameters.

Press the key, and digit selection is changed in the order from the 1st, 5th, decimal point, 4th, 3rd, 2nd, and back to the 1st.

Press the key to move the decimal point to the left, and press the key to move it to the right. When it is moved to the end, it is then moved to the other end.

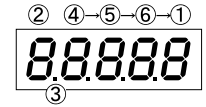

5-15 Remote operation prohibition

rih1 Remote operation prohibition setting (Setting range: ON, OFF)

[Description]

1) rih1 (Ch9-7)

- Remote operation can be prohibited. (See the following table.)
- Use this function when remote operation function is not required.

<i>rih1</i>	Remote operation
OFF	Allowed
ON	Prohibited

When rih1 is set to ON, R-ACK of Di function, SV selection of Di function, remote operation function with REM1 parameter, and remote operation function at the time of power ON cannot be used.

5-16 Remote acknowledge (R-ACK) function

rAC1 Setting of permission of switching to remote operation with Di (Setting range: EnA, inh)

[Description]

1) rAC1 (Ch9-11)

- Setting of permission of switching to Remote/Auto operation can be made with Di.
- To use this function, set TPLT (Ch8-92) to 10, 13 or 16, rAC1 (Ch9-11) to EnA, rEM (Ch1-1) to rEM, and 60 (Remote acknowledge) to either of Di01 to Di15 (Ch9-39 to 47).

Setting	Explanation
EnA (Enable)	“Remote mode” allowed with Di
Inh (inhblt)	“Remote mode” prohibited with Di

Operation mode	Di (R-Ack)	Indication lamp status
Remote Auto	ON	R ON,
	OFF	R flickers, A ON
Manual	ON	M ON, R flickers
	OFF	M ON, A flickers

5-17 Manual operation prohibition

A-n1 Setting manual operation prohibition (Setting range: A-M, A)

[Description]

1) A-M1(Ch9-15)

- Manual operation can be prohibited. (See the following table.)
- Use this function when manual operation function is not required.

Setting	Manual operation
A-M	Allowed
A	Prohibited

When manual operation is prohibited, forced manual operation (SMV) and manual power ON by Di function cannot be performed.

5-18 Operation mode at the time of power ON

Cnd1 Operation mode setting at the time of power ON (Setting range: A, R, M)

[Description]

1) Cnd1 (Ch9-19)

- Operation mode at the time of power ON can be set.
 - Operation mode can be selected from the following three option below.
 - A: Auto operation
 - R: Remote operation
 - M: Manual operation

 - Setting Cnd1 to R (Remote operation)
Under Remote operation prohibition setting, the instrument is started by Manual operation when SMV of Di function is set to ON, and in other cases, it is started by Auto operation.
 - Setting Cnd1 to M (Manual operation)
Under Manual switching prohibition setting, the instrument is started by Remote operation when R-Ack of Di function is set to ON and rEM1 (Ch1-1) is set to rEM in SV selection, and in other cases, it is started by Auto operation.
- * See section 4-1 “Auto operation,” section 4-2 “Manual operation,” and section 4-3 “Remote operation” for details of each operation.

5-19 SV tracking function

Trk1 SV tracking function ON/OFF setting (Setting range: ON, OFF)

[Description]

1) TRK1 (Ch9-23)

- Tracking of RSV (remote SV) to LSV (local SV) is allowed when operation is switched from Remote to Auto, which is called SV tracking function.

ON: Tracking is performed. (Local SV = Remote SV)

OFF: Tracking is not performed. (Local SV \neq Remote SV)

Local value at the time of switching to remote operation is restored.

[Example]

When TPLT (Ch8-92) is set to 10 or 13, Local SV is set to 200.0, and Remote SV is set to 0.0

When Trk1 = ON

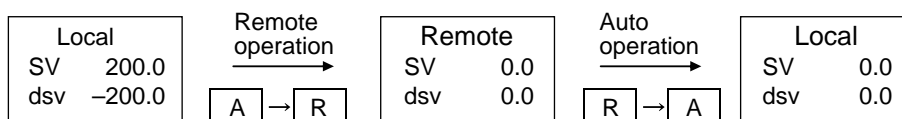

When Trk1 = OFF

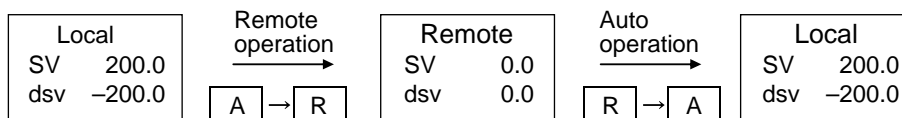

* See section 3-1 “Setting control template” for details of TPLT (Ch8-92).

[Note]

- If setting is changed from Remote SV to Local SV during Manual operation, the instrument operates as shown above.
- During Remote operation, SV tracking setting is used when setting is changed from Remote SV to Local SV both in auxiliary input Ai1 and SV selection methods.
- When operation is switched to remote SV operation during Ramp/soak and then switched to local SV operation again, SV value will be switched to Ramp/soak SV value even though SV tracking function is set to ON.

5-20 Password

PS1 **PS2** Password entry (Setting range: 0000 to FFFF)

PAS1 **PAS2** **PAS3** Password setting (Setting range: 0000 to FFFF)

[Description]

1) PS1-PAS1 (The function prevents people other than the administrator from changing the setting of this instrument.)

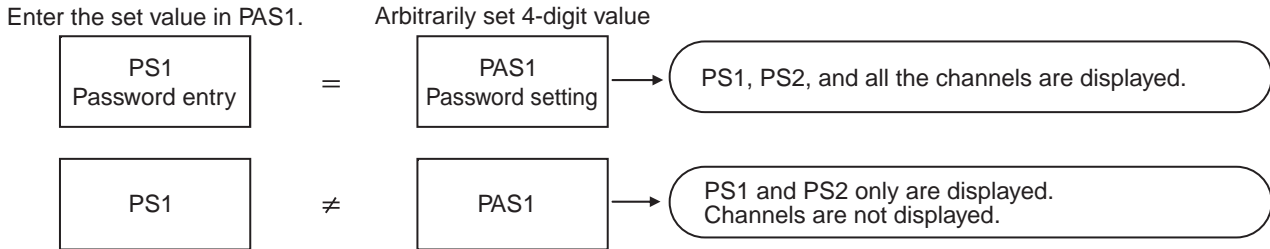

* Please be sure to note the registered password.

2) PS2-PAS2 (The function prevents people other than the administrator from changing the settings except for Ch1 oPE (operation parameter).)

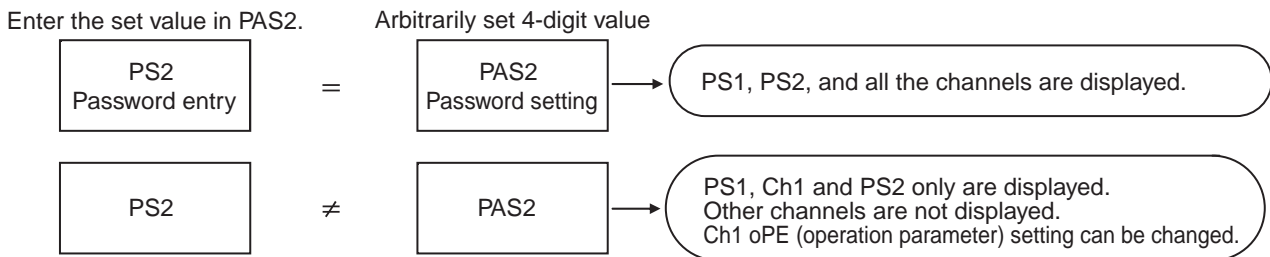

* Please be sure to note the registered password.

[Note]

- If the password is lost,

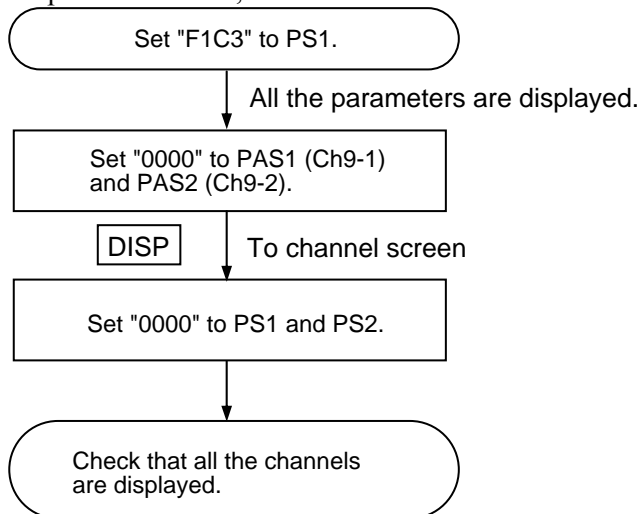

- * If "F1C3" is selected, parameters not displayed in normal times are displayed. Never change the parameters that are not displayed in normal times. Otherwise a failure may occur.
- * PAS3 is for maintenance work. Never change the setting. Otherwise a failure may occur.

5-21 Parameter mask

d500 to d543 Parameter mask setting (Setting range: 0000 to FFFF)

[Description]

1) ds00(Ch9-80) to ds43(Ch9-C3)

- Unnecessary (unused) parameters can be masked (non-display).
- This function can be used to prevent settings from being changed by mistake.
- See “Display mask” in the parameter list for correspondence between ds00 (Ch9-80) to ds43 (Ch9-C3) setting and parameters to be masked (non-display).
- See the following setting example for setting method.

[Setting example]

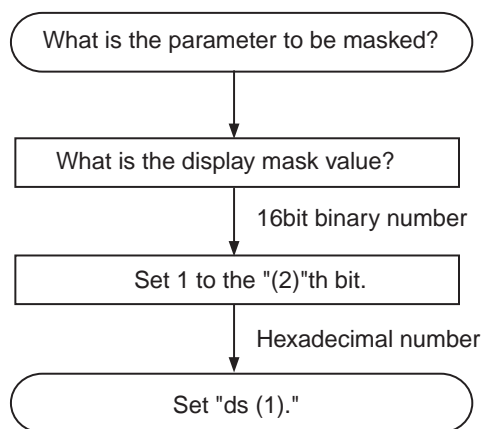

[Example] TC1

Parameter mask definition is below (See Appendix 2 Parameter List)

$\frac{03}{(1)}$	-	$\frac{13}{(2)}$			
4th digit 13	3rd digit 9	2nd digit 5	1st digit 1	Digit of hexadecimal number	No. of digits of binary number
0 0 0 1	0 0 0 0	0 0 0 0	0 0 0 0	Binary number	Binary number
1	0	0	0	Hexadecimal number	Hexadecimal number
1000(16)					
↓					
Set 1000 to ds03 to mask TC1.					

Note:

- When the setting of the parameter (dsxx) whose setting is to be changed is other than 0, add current set value to the value calculated as shown above.

Factory-set value of ds00 to ds43

ds	Set value	ds	Set value	ds	Set value	ds	Set value	ds	Set value
00	8000	10	0002	20	0038	30	00EE	40	00FC
01	002E	11	0002	21	0038	31	0404	41	01FF
02	0000	12	0002	22	01FF	32	1D00	42	01FF
03	4622	13	0002	23	001A	33	0000	43	01FF
04	FFFF	14	0002	24	01dF	34	FF00		
05	FFFF	15	0000	25	80FC	35	0003		
06	FFFF	16	003E	26	0018	36	0C31		
07	0002	17	0E24	27	0EEE	37	0314		
08	0002	18	000E	28	0E0E	38	0010		
09	0002	19	0002	29	0007	39	0076		

- Do not display parameters masked at the time of delivery and change the setting. Otherwise a failure may occur.

5-22 EX-MV function

EXM1

External manipulated value setting (Setting range: -25 to 125%)

[Description]

1) EXM1 (Ch2-97)

- In this mode, the instrument is operated with the MV value set according to the value of external manipulated value EXM1.
- During EX-MV operation, ordinary MV follows EX-MV.
- To set the control mode to EX-MV, set the EX-MV value and then set Di to ON.

Di input	Output signal
OFF	MV (PID result)
ON	EX-MV

- * During Manual operation, if Di allocated with EX-MV is set to ON, EX-MV is not output, but MV set on the operation screen (Manual MV) is output.
- * Allocation is made to Di4 of each template at the time of delivery.
If EX-MV value is not output when Di4 is set to ON, check if EX-MV (103) is allocated to Di (Ch9-39 to 47).

5-23 Setting 2 degrees of freedom PID

ALP1 2 degrees of freedom coefficient α setting (Setting range: -300.0 to 300.0%)

bET1 2 degrees of freedom coefficient β setting (Setting range: 0.0 to 900.0%)

[Description]

The function is used to suppress overshoot generated in PID control.

The 2 degrees of freedom PID system of this instrument adopts set value (SV) filter method, which is effective at suppressing overshoot at the time of setting change or power ON.

If ALP1 (α) is set to 100.0%, and bET1 (β) to 0.0%, ordinary PID control (1 degree of freedom PID) is performed.

Adjust ALP1 (α) and bET1 (β) as follows.

- 1) Set ALP1 (α) to 40.0%, and bET1 (β) to 100.0%.
- 2) Perform control and check responsibility (overshoot volume).

If overshoot cannot be improved in this stage, adjust ALP1 (α) and bET1 (β), following the definition listed in the following table.

If ALP1 (α) is generally not required adjusting.

Therefore, it is recommended that you to use the instrument with ALP1 (α) set to 40.0%.

Result of control	bET1	ALP1
Large overshoot	Increase BET1 (β) by 20%	Decrease ALP1 (α) by 10%
Small overshoot	Decrease BET1 (β) by 20%	Increase ALP1 (α) by 10%

[2 degrees of freedom PID block diagram]

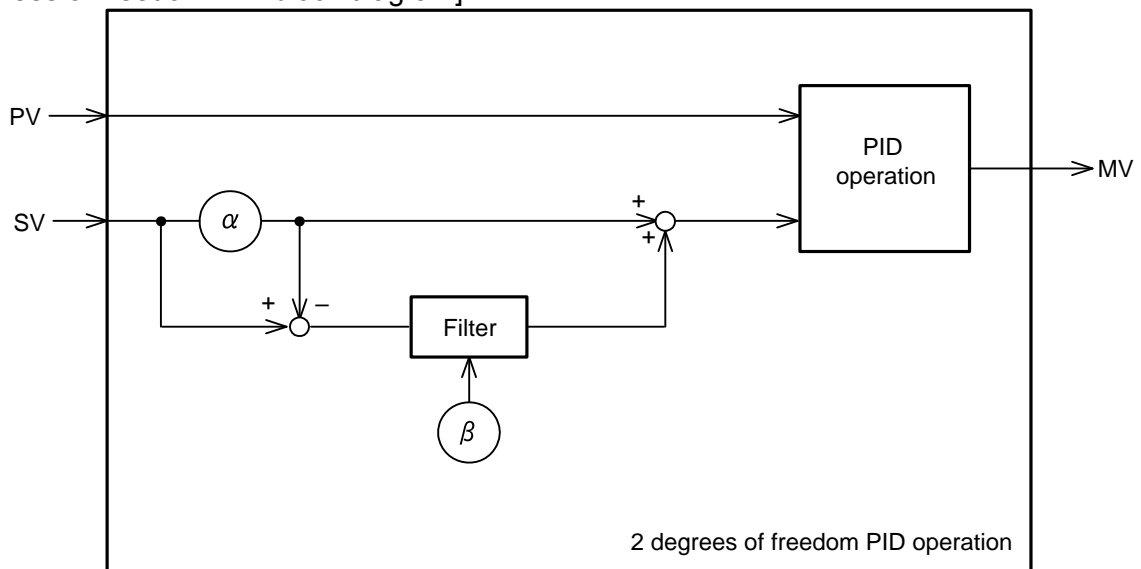

[Note]

- * Change the setting of ALP1 (α) in manual mode.
Before changing ALP1 (α) setting, set bET1 (β) to 0.0%. Change ALP1 (α) setting, and then set desired value to bET1 (β) again. Improper procedure may cause output (target value) to increase temporarily, thus posing danger.
- * The purpose of this function is to suppress overshoot generated in ordinary PID control. Overshoot may not always be eliminated.

5-24 Screen display selection function

odSP Operation display setting (Setting range: 000 to 111)

[Description]

Items to be displayed on the operation screen can be selected with parameters.
Make the following parameter setting for operation display setting odSP (Ch9-79).

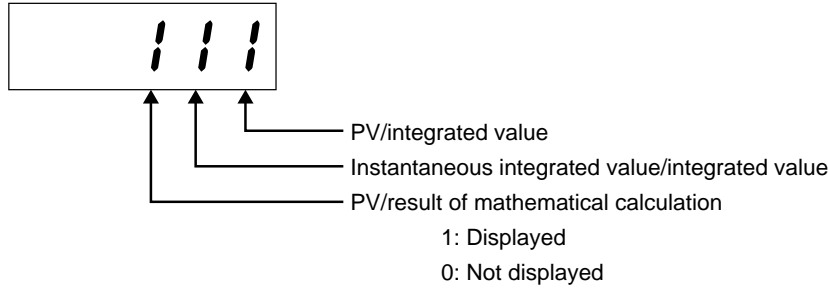

The display shifts as follows during operation.

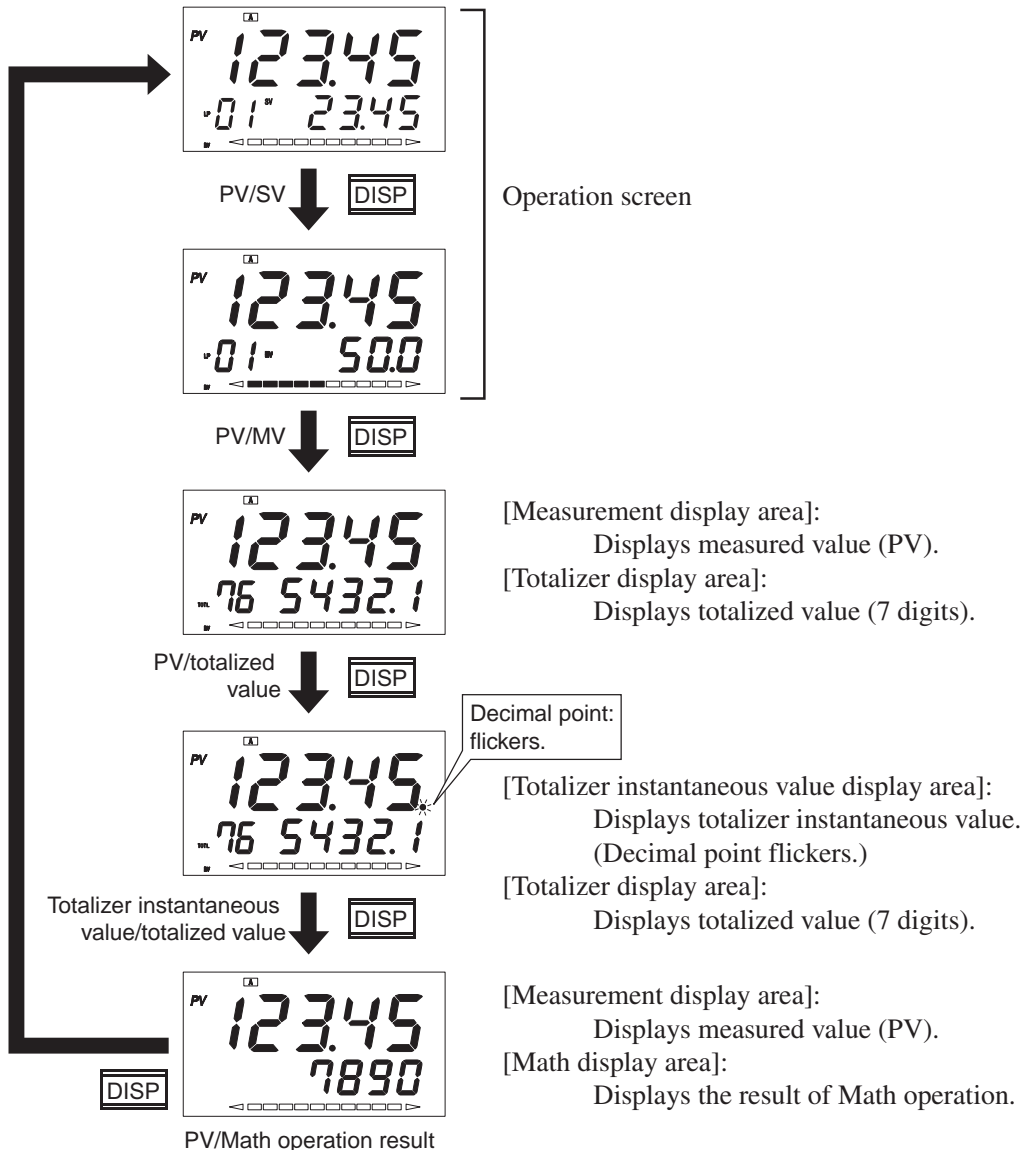

5-25 Totalizer function

[Description]

Description of totalizer function

The totalizer function can be used to select one point from PV1, PV2, Ai1, and AiM, and totalize the input values. The totalized value can be displayed on the screen.

Totalized value display

PV/totalized value display and totalizer instantaneous value/totalized value display can be displayed on the operation screen using the screen display selection function odSP (Ch9-79).

Switching is made every time the DISP key is pressed on the operation screen.

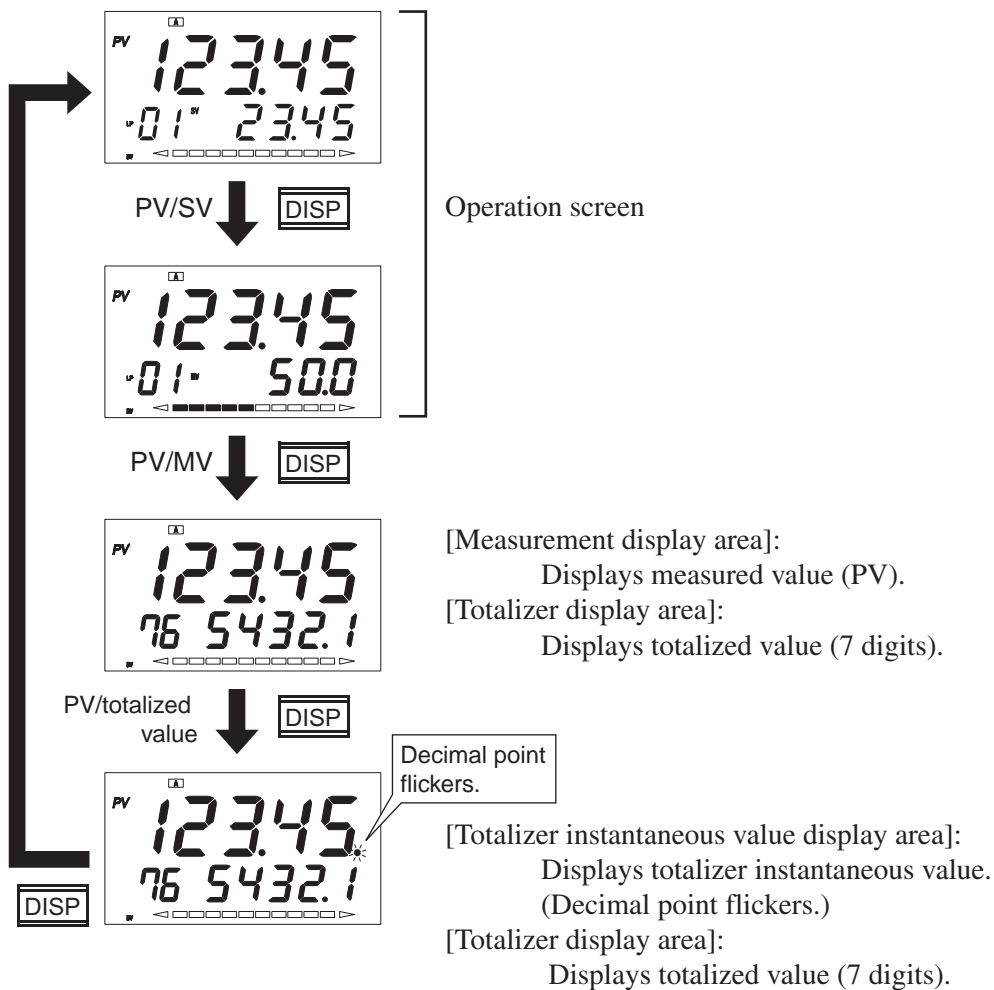

5. ADVANCED USAGE

rMod Totalizer operation mode setting (Setting range: 0, 1)

[Description]

The totalizer function is available in 2 modes, Japanese mode and English mode. Mode selection is allowed by parameter setting. Description of each mode and setting method are described below.

1) Japanese mode

Calculation is carried out using totalizing factor.

Totalizing factor TCF (ChG-17): Sets the totalized value display when 100% input is continued for 1 hour. (Setting range: 20 to 9999999)

2) English mode

Totalized value display by totalizer reference time, integration divisor, and integration multiplier

Totalizer reference time Tb (ChG-14): Sets the reference time of input signals. Integrated value per reference time is displayed.

(Setting range: sec/min/hour/day)

Scaling value SCL (ChG-15): Divisor for integrated value scale conversion. The value divided by the divisor is used as integrated value.

(Setting range: 0 to ±1000000)

Input multiplier MUL (ChG-16): Multiplier for integrated value scale conversion. The value multiplied by the multiplier is used as integrated value.

(Setting range: 0 to ±1000000)

$$\begin{array}{c}
 \boxed{\text{Input value (Engineering value)}} \times \boxed{\text{Input multiplier MUL}} + \boxed{\text{Remainder of previous operation}} \\
 \hline
 \boxed{\text{Totalizer time base Tb}} \times \boxed{\text{Scaling value SCL}} + \text{Previous totalized value} = \text{Totalized value}
 \end{array}$$

TMod(ChG-12)

Setting	Setting contents
JPn	Japanese mode
EnG	English mode

rUn Totalizer RUN/HOLD and LATCH (Setting range: HoLd/rUn/LATcH)

[Description]

1) TrUn (ChG-1)

Totalizer is started/stopped and latched as follows.

- When power is turned on: Selection can be made from RUN and HOLD.
- During standby: Totalizer is not performed during standby. RESET operation is allowed. Since totalizer alarm is set to OFF during standby, alarm judgment is not made.
- Totalizer operation is continued in other modes.

Parameter	Operation
RUN	Starts totalizer, makes totalizer alarm judgment.
HOLD	Stops totalizer, continues instantaneous value display, holds totalizer alarm output.
LATCH	Stops totalizer display, continues totalizer, stops instantaneous value display, continues totalizer alarm operation.

2) Allocation to Di function

- Operation can be allocated to Di.
- The following totalizer operations can be allocated to parameters Di01 (Ch9-39) to Di04 (Ch9-42) and Di11 (Ch9-43) to Di15 (Ch9-47).

Di setting Di1 to Di15	Di input	
	OFF	ON
160	RUN	HOLD
161	RUN	LATCH

[Note]

- If RUN/HOLD and RUN/LATCH functions are allocated to Di at the same time, the one with larger Di number takes precedence in operation over the other.
- If RUN/HOLD and RUN/LATCH functions are allocated to Di, parameter setting or allocation to function keys cannot be performed.

3) Allocation to function keys

- Totalizer operation can be allocated to function keys.
- The following totalizer operations can be allocated to parameters F1 (Ch9-32) to F3 (Ch9-34).]

Function key code, F1 to F3	Function
30	RUN / HOLD
31	RUN / LATCH

5. ADVANCED USAGE

TrES Totalizer reset (Setting range: ON, OFF)

[Description]

1) TrES (ChG-2)

Totalizer can be reset.

ON: Clears totalized value, totalizer alarm OFF

Automatically returns to OFF state after the reset.

2) Allocation to Di function

- Reset function can be allocated to Di.
- The following Di settings can be allocated to parameters Di01 (Ch9-39) to Di04 (Ch9-42) and Di11 (Ch9-43) to Di15 (Ch9-47).

Di setting Di1 to Di15	Di input	
	OFF	ON
162	—	Reset

3) Allocation to function keys

- Totalizer operation reset function can be allocated to function keys.
- Totalizer reset function can be allocated to parameters F1 (Ch9-32) to F3 (Ch9-34).

Function key code, F1 to F3	Function
32	Totalizer reset

ToIn Totalizer input source setting (Setting range: PV1, PV2, Ai1, AiM)

[Description]

ToIn (ChG-3)

- Input source used for totalizer can be selected.
- Select one from PV1, PV2, Ai1, and AiM as totalizer input.

Parameter	Input source
PV1	Measurement input 1
PV2	Measurement input 2
Ai1	Auxiliary analog input
AiM	Result of Math operation

r d P Totalizer decimal point position setting (Setting range: 0 to 4)

[Description]

TdP (ChG-4)

Decimal point position in totalized value display can be set.

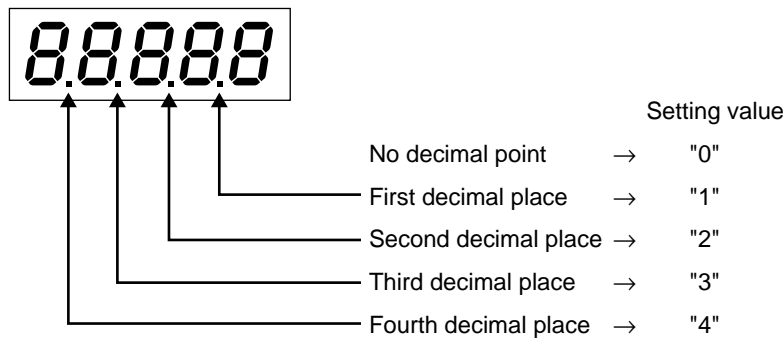

[Note]

- Once the decimal point position is changed, the decimal point position of totalizer conversion factor (TCF (ChG-17)), totalizer initial value (TihT (ChG-18)), totalizer alarm 1 setting (A1SP (ChG-19)), totalizer alarm 2 setting (A2SP (ChG-20)), and re-transmission output source scale (rTSc (ChG-21)) is also changed. Check the decimal point position of each parameter.
- In the case of English operation mode, once the decimal point position is changed during totalize operation, the digit of totalizer is changed. Be sure to reset the totalized value before changing the decimal point position.

r C U F Integration cut point setting (Setting range: 0 to 100%FS)

[Description]

TCUT (ChG-5)

Integration cut point for totalizer input can be set.

Input lower than the integration cut point is not added to totalized value.

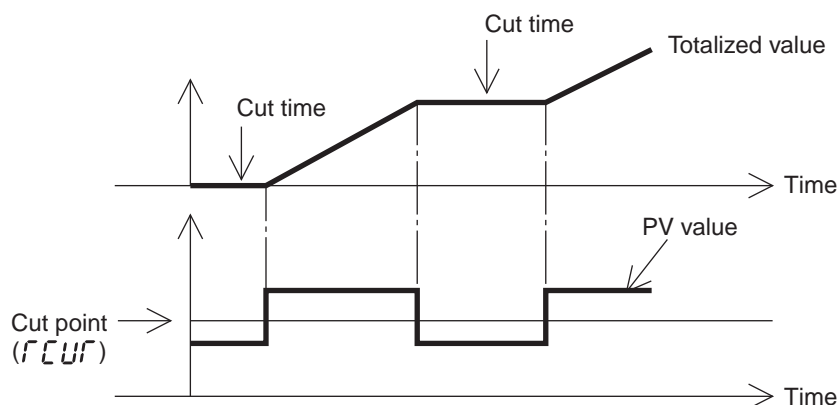

[Note]

- In the case of English operation mode, if minus value is selected, the integration cut point becomes 0.
- The decimal point appears according to the decimal point position setting of measurement input.

5. ADVANCED USAGE

A1TP Totalizer alarm 1 alarm type setting (Setting range: 0 to 3)

A2TP Totalizer alarm 2 alarm type setting (Setting range: 0 to 3)

[Description]

A1TP (ChG-6), A2TP (ChG-9)

- Alarm type of totalizer alarms 1 and 2 can be set.
The alarm type can be selected from the three types listed in the following table.

A1TP A2TP	Alarm type
0	No alarm
1	Totalized value alarm
2	Batch control output
3	Batch control output (with auto reset)

1) Totalized value alarm output

- Plus alarm setting: Alarm comes ON when totalized value > alarm setting.
- Minus alarm setting: Alarm comes ON when totalized value < alarm setting.
Totalized alarm is set to OFF by reset input TrES (ChG-2).
Or, it is also set to OFF by auto reset, display overflow reset, or setting the totalizer initial value at which alarm comes OFF.

2) Batch control output

- Plus alarm setting: Alarm comes ON when integrated value > alarm setting.
- Minus alarm setting: Alarm comes ON when integrated value < alarm setting.
Select pulse width from parameters A1on (ChG-7) and A2on (ChG-10).
(100ms/200ms/500ms/1s/Continuous)
If continuous output is set to pulse width, alarm output is set to OFF by performing totalizer reset TrES (ChG-2).

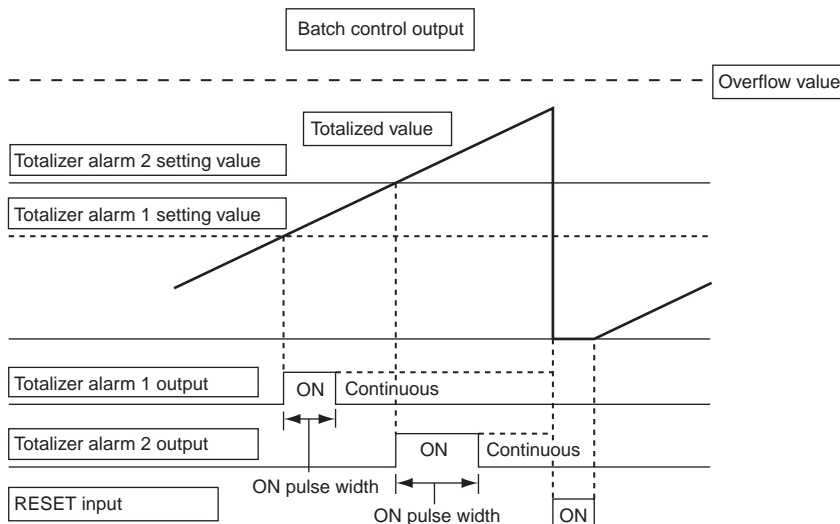

Note: The pulse width error falls within 0 to 50msec.

3) Batch control output (with auto reset)

- Plus alarm setting: Alarm is set to ON when integrated value > alarm setting.
 - Minus alarm setting: Alarm is set to ON when integrated value < alarm setting.
- Select pulse width from parameters A1on (ChG-7) and A2on (ChG-10).
(100ms/200ms/500ms/continuous)

If the pulse width is set to continuous, alarm output is set to OFF by performing totalizer reset TrES (ChG-2).

Auto reset function: Resets the totalizer when the alarm output comes ON.

If the pulse width is set to continuous, totalizer alarm is not set to OFF at the time of auto reset.

OFF action of the batch control output

Alarm ON pulse width	by Auto reset	by Reset input
Continuous output	Not set to OFF.	OFF
Others	Set to OFF after the output of ON pulse width irrespective of reset input.	

When the totalizer initial value is the same or larger than the alarm setting, resetting is made immediately and the totalizer starts is started from 0.

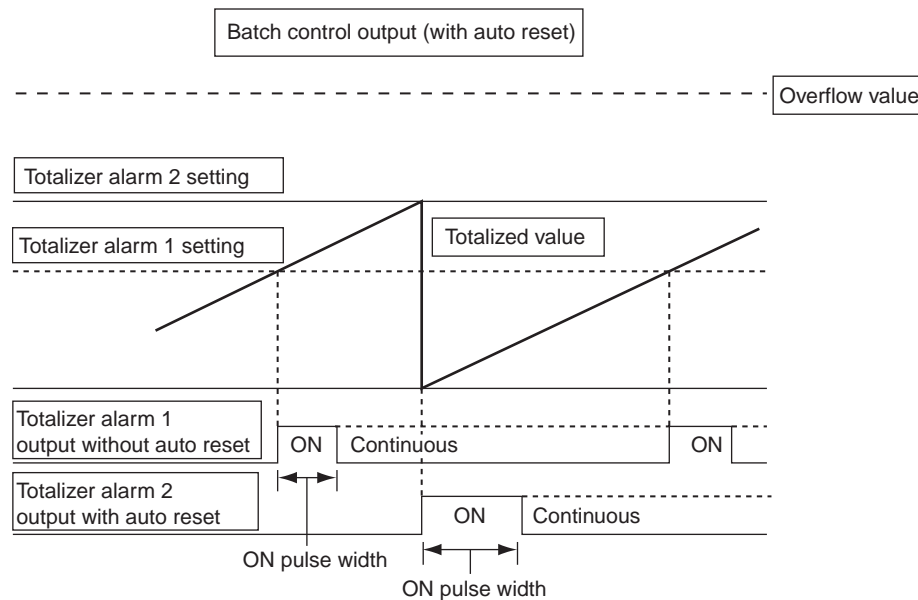

Note: The error of pulse width falls within 0 to 50msec.

5. ADVANCED USAGE

A1on Totalizer alarm 1 ON pulse width setting (Setting range: 0 to 4)

A2on Totalizer alarm 2 ON pulse width setting (Setting range: 0 to 4)

[Description]

A1on (ChG-7), A2on (ChG-10)

- The ON pulse width can be set for batch control output of totalizer alarms 1 and 2. The pulse width can be selected from the 5 types listed in the following table.

A1on A2on	ON pulse width
0	Continuous
1	100ms
2	200ms
3	500ms
4	1sec

A1oP Totalizer alarm 1 excitation, non-excitation setting (Setting range: 0, 1)

A2oP Totalizer alarm 2 excitation, non-excitation setting (Setting range: 0, 1)

[Description]

A1oP (ChG-8), A2oP (ChG-11)

- Excitation or non-excitation output for totalizer alarms 1 and 2 can be set.

Setting	Setting contents
0	Excitation
1	Non-excitation

When excitation is selected
for totalizer alarm

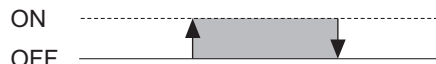

When non-excitation is selected
for totalizer alarm

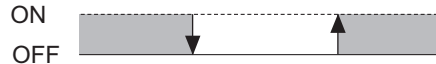

roPr Totalizer option setting (Setting range: 0000 to 1111)

[Description]

ToPT (ChG-13)

Additional functions of totalizer operation can be set.

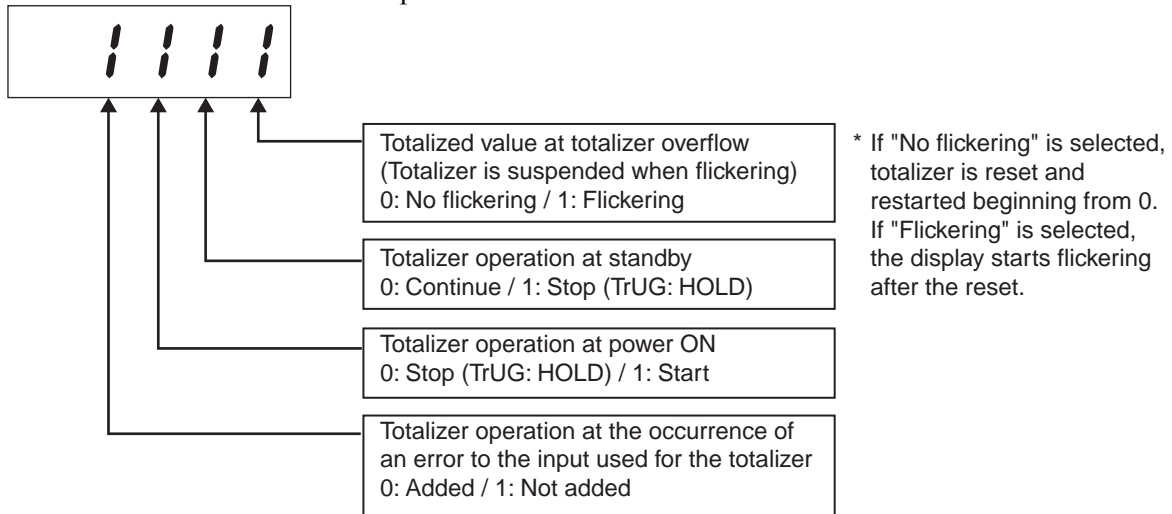

rb Totalizer time base setting (Setting range: SEC, Min, hour, dAY) (only for English mode)

[Description]

Tb (ChG-14)

The unit of integration reference time can be set.

Time base
SEC
Min
hour
dAy

SCL Totalizer scaling value setting (Setting range: 0 to ± 1000000) (only for English mode)

[Description]

SCL (ChG-15)

- The unit of totalized value can be transformed from the unit of input value..

Example:

Unit of totalizer input	Unit of totalizer value	SCL
cm ³	m ³	1000000
g	kg	1000

Note: Do not select 0. If 0 is selected, the value is not added to integrated value.

5. ADVANCED USAGE

MUL Input multiplier setting (Setting range: 0 to ±1000000) (only for English mode)

[Description]

MUL (ChG-16)

- The unit of totalized value can be transformed from the unit of input value.

TCF Totalizer conversion factor setting (Setting range: 20 to 9999999) (only for Japanese mode)

[Description]

TCF (ChG-17)

Integrated value display, when 100% input is continued for 1 hour.

Note: The decimal point position is determined according to the totalizer decimal point position setting TdP (ChG-4).

TinT Totalizer initial value setting (Setting range: -1999999 to 9999999)

[Description]

TinT (ChG-18)

When totalizer initial value is changed, the current totalized value is changed to changed value.

Note: The decimal point position is determined according to the totalizer decimal point position setting TdP (ChG-4).

A1SP Totalizer alarm 1 set value setting (Setting range: -1999999 to 9999999)

A2SP Totalizer alarm 2 set value setting (Setting range: -1999999 to 9999999)

[Description]

- 1) A1SP (ChG-19), A2SP (ChG-20)

The operation value for totalizer alarms 1 and 2 can be set.

Note: The decimal point position is determined according to the totalizer decimal point position setting TdP (ChG-4).

rTSC Re-transmission output scale setting (Setting range: -1999999 to 9999999)

[Description]

rTSC (ChG-21)

The totalized value can be set so that re-transmission output becomes 100%.

Note: This setting is enabled only when “TV” is selected for re-transmission output type.

Example: When rTSC = 50000L

Output becomes 50% (12mA) when totalized value is 25000L.

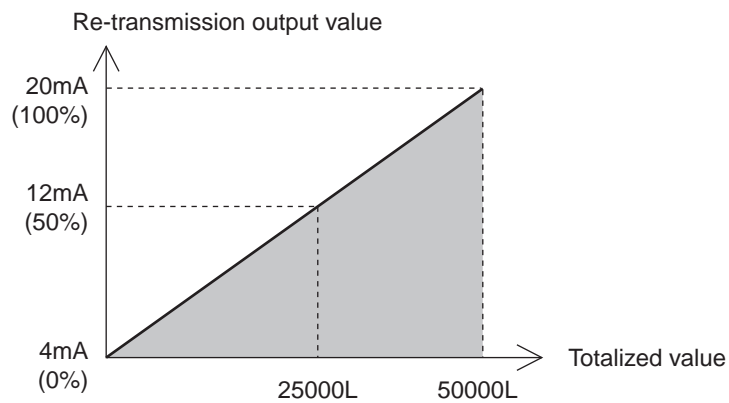

5-26 Recipe function

Description of the recipe function

The recipe function is used to switch the values of the parameters registered as recipe parameters, synchronized with the switching of control palettes.

Select the setting for each control palette for parameters d00 to d79. (Refer to the description on the next page for details.)

rCP0 to **rCP9** Recipe allocation (Setting range: 0-00 to W-Z9)

[Description]

- 1) rCP0 to rCP9 (ChX-1 to 10)

Parameters to be allocated to recipe parameters can be set.

Symbol	Name	Description
rCP0	Recipe allocation 1	Select parameter to be allocated as recipe 1
rCP1	Recipe allocation 2	Select parameter to be allocated as recipe 2
rCP2	Recipe allocation 3	Select parameter to be allocated as recipe 3
rCP3	Recipe allocation 4	Select parameter to be allocated as recipe 4
rCP4	Recipe allocation 5	Select parameter to be allocated as recipe 5
rCP5	Recipe allocation 6	Select parameter to be allocated as recipe 6
rCP6	Recipe allocation 7	Select parameter to be allocated as recipe 7
rCP7	Recipe allocation 8	Select parameter to be allocated as recipe 8
rCP8	Recipe allocation 9	Select parameter to be allocated as recipe 9
rCP9	Recipe allocation 10	Select parameter to be allocated as recipe 10

Make parameter setting using channel| parameter numbers.

[Example] When setting the alarm setting 1 AL1 (Ch1-10) for recipe allocation 1 rCP0

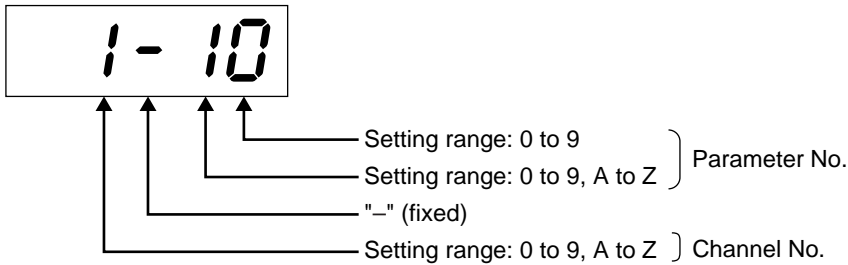

d00 to **d79** Recipe set value setting (Setting range: Depends on the setting range of parameter set in recipe allocation.)

[Description]

Set the value that corresponds to each control palette of parameters allocated to recipe allocation 1 to 10. (The setting range is the same as that of parameters to which recipes are allocated.)

The correspondence between control palette numbers and recipe-related parameters is shown below.

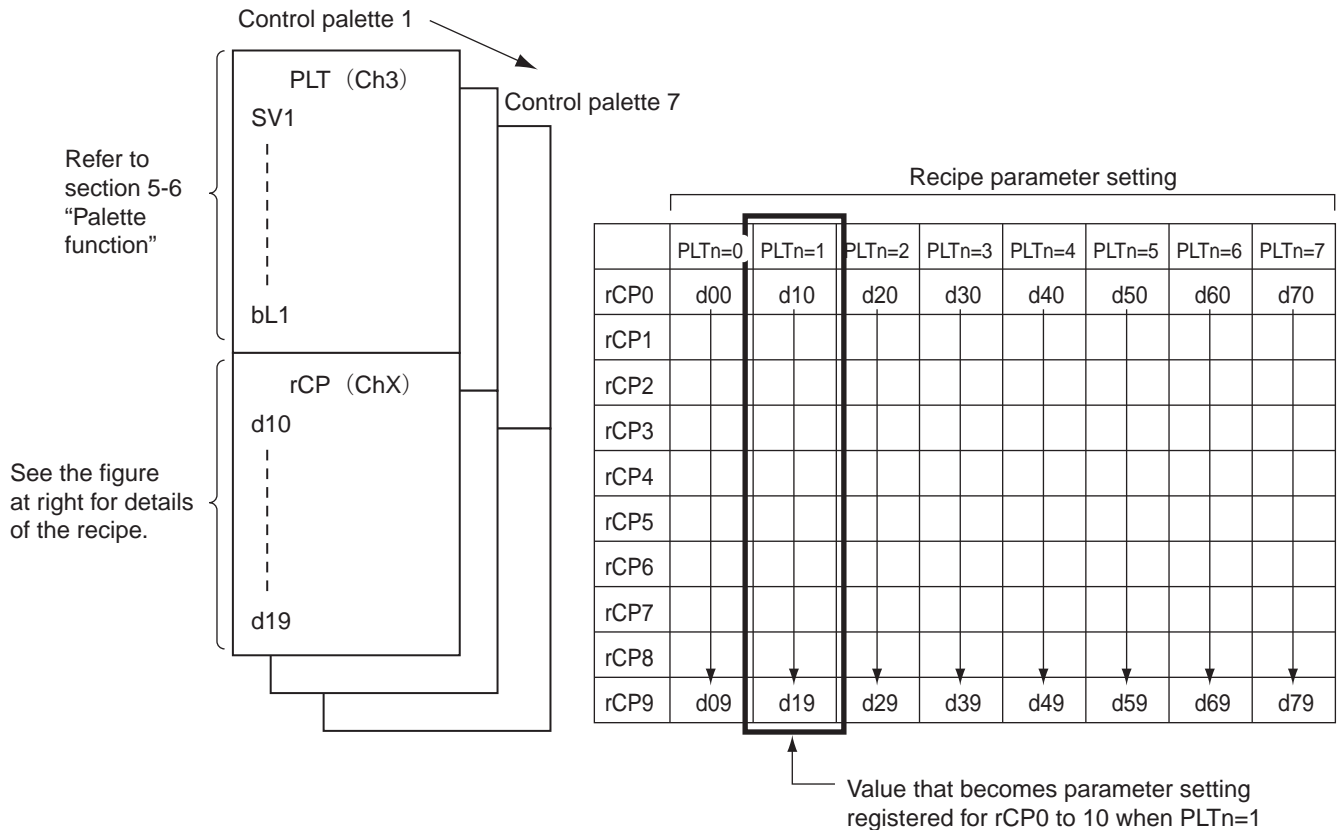

D00 to d79 (ChX-11 to 90)

1) d00 to d09 (ChX-11 to 20): Setting that corresponds to the situation where none of control palettes for recipe allocation 1 to 10 are selected

d10 to d19 (ChX-21 to 30): Setting that corresponds to control palette 1 of recipe allocation 1 to 10

d20 to d29 (ChX-31 to 40): Setting that corresponds to control palette 2 of recipe allocation 1 to 10

d30 to d39 (ChX-41 to 50): Setting that corresponds to control palette 3 of recipe allocation 1 to 10

d40 to d49 (ChX-51 to 60): Setting that corresponds to control palette 4 of recipe allocation 1 to 10

d50 to d59 (ChX-61 to 70): Setting that corresponds to control palette 5 of recipe allocation 1 to 10

d60 to d69 (ChX-71 to 80): Setting that corresponds to control palette 6 of recipe allocation 1 to 10

d70 to d79 (ChX-81 to 90): Setting that corresponds to control palette 7 of recipe allocation 1 to 10

[Note]

- Masked parameters cannot be registered as recipes.
- Recipe allocation setting is enabled after the main unit is reset or power ON again.
- The following parameters cannot be used as recipe parameters. Do not select them for recipe allocation (rCP0 to 9).

5. ADVANCED USAGE

[Parameters that cannot be registered]

Ch3 (PLT channel)	Ch7 (MON channel)	Ch8 (SET channel)
Ch9 (SYS channel)	ChA (ALM channel)	ChB (Com channel)
ChT (TLK channel)	ChX (RCP channel)	
STBY (Ch1-5)	AT (Ch1-7)	PLTN (Ch1-9)
LACH (ch1-8)	RES (Ch9-E3)	TrUn (chG-1)
TrES (chG-2)	TinT (chG-18)	CALB (chF-8)

[Example]

To change the alarm setting (AL1) to 100.0°C when control palette is not used (PLTn=0), the alarm setting (AL1) to 200.0°C when control palette 1 is selected (PLTn=1), and the alarm setting (AL1) to 300.0°C when control palettes 2 to 7 are selected (PLTn=2 to 7), select recipe-related parameters as follows.

Parameter	Setting
rCP0 (Recipe allocation 1)	1-10
d00 (Value when PLTn=0 holds)	100.0
d10 (Value when PLTn=1 holds)	200.0
d20 (Value when PLTn=2 holds)	300.0
d70 (Value when PLTn=7 holds)	

5-27 Linearize function

$P1Ln$	PV1 input linearize setting	}	(Setting range: OFF, nrML, hi-C, Lo-C)
$P2Ln$	PV2 input linearize setting		
$A1Ln$	Ai1 input linearize setting		

[Description]

- Linear conversion is performed by 16 straight-line table specific to each input (PV1, PV2, Ai1).
- Select linearize output from the following 3 types.

$P1Ln$ (Ch8-13), $P2Ln$ (Ch8-26), $A1Ln$ (Ch8-51)

Select enable/disable of linearize function of each input.

OFF: Linearize disabled

NrML: Values outside the table range is output without making conversions.

hi-C: Values higher outside the table is limited.

Lo-C: Values lower outside the table is limited.

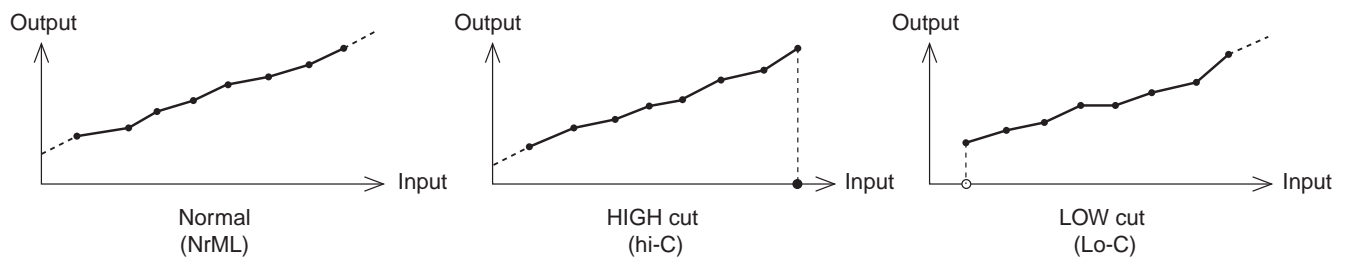

5. ADVANCED USAGE

P 1X0 to **A 1YF** Linearizer table setting (Setting range: -25 to 125%FS)

[Description]

P1X0 to A1YF (ChC-1 to 128)

- 1) The settings of the X-axis and the Y-axis of the linearize table for PV1 input (P1X0 to P1YF), for PV2 input (P2X0 to P2YF), and for Ai1 input (A1X0 to A1YF) are set as follows.
- 2) Sixteen straight-line setting can be made for each table.
- 3) The following table shows the broken-line table.

Input	Output
X0	Y0
X1	Y1
X2	Y2
X3	Y3
X4	Y4
X5	Y5
X6	Y6
X7	Y7
X8	Y8
X9	Y9
XA	YA
XB	YB
XC	YC
XD	YD
XE	YE
XF	YF

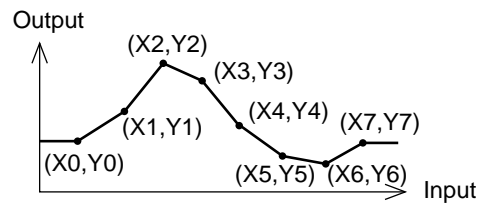

5-28 Data change through communications

(1) MV value setting in manual mode (Setting range: -250 to 1250)

[Description]

If data is written into the manual MV exclusive for communications, the MV value can be changed in manual mode.

- * The data is tracked to calculated value MV in modes other than manual mode.
- * The data is limited within the range from -25% to 125% if values that do not fall within that range are specified.

(2) Di function through communications

[Description]

In addition to terminals 1 to 4 and Di11 to 15, communication-Di can be used. Communication-Di functions can be allocated to Ci01 to Ci08, (chb-51 to 58).

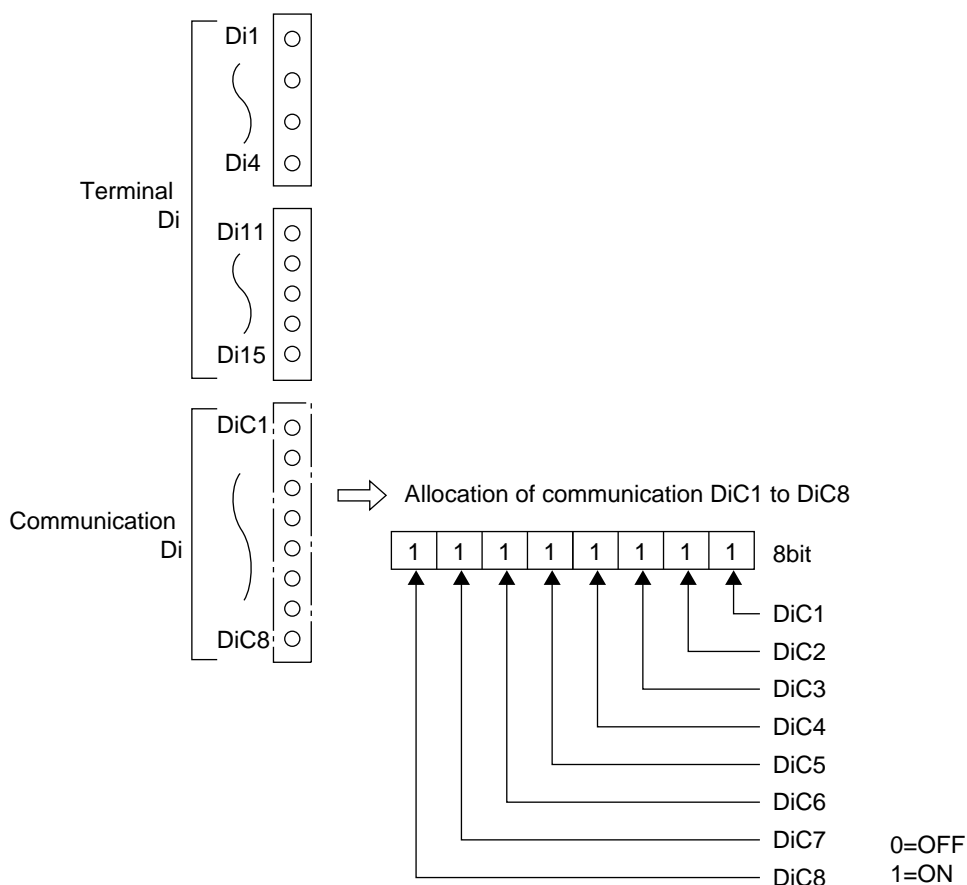

- * See the communication manual for MODBUS communication address of communication Di.

5. ADVANCED USAGE

C201 to C208 Communication Di function setting (Setting range: 0 to 255)

[Description]

- 1) Ci01 to Ci08 (Chb-51 to 58)

Function setting is the same as Di function setting. (See 5-10 “Digital input (Di) function” .)

(3) RSV change through communications (for Template 16)

[Description]

Change of RSV setting is allowed through communication.

- Select communication RSV using the RSV signal selector switch.

<Setting method>

Set CN02 (ch8-99) = 5.

This allows values to be set through communications.

See the communication manual for the MODBUS communication address of communication RSV.

5-29 MV polarity reverse function

AO 1H Ao1 output scale upper limit value (Setting range: -130.0% to 130.0%)

AO 1L Ao1 output scale lower limit value (Setting range: -130.0% to 130.0%)

[Description]

- The function can be used only for current output. (Control output type OTYP is enabled when it is 10 or 12.)
- Setting method

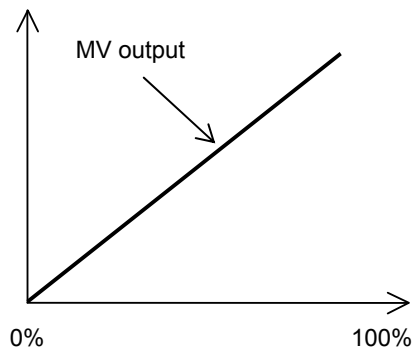

When setting is made as follows
(forward direction)
Ao1L=0.0, Ao1H=100.0

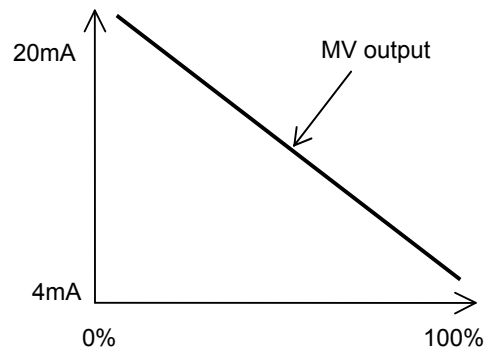

When setting is made as follows
(reverse direction)
Ao1L=100.0, Ao1H=0.0

5-30 Ramp/Soak

PrG Ramp/Soak activation Command (Setting range: oFF, rUn, hLd)

Prn Ramp/Soak activation Pattern (Setting range: 0 to 30, di)

rLNU Ramp/soak time units (Setting range: hh.MM.MM.SS)

Sv-1 to **Sv64** S V setting value (setting range: 0 to 100%FS)

rnr to **r64r** Ramp time (setting range: 00:00 to 99:59)

rns to **r64s** Soak time (setting range: 00:00 to 99:59)

nod Ramp/soak mode (setting range: 0 to 15)

GSoK Guaranty soak ON/OFF (setting range: oFF, on)

GSh Guaranty soak band (upper) (setting range: 0 to 50%FS)

GSl Guaranty soak band (lower) (setting range: 0 to 50%FS)

PvSt PV start (setting range: oFF, on)

Conf Continue mode (setting range: rES, Con, ini)

Prnn Sets the max pattern (setting range: 0 to 30, di)

PnLn Sets the min pattern (setting range: 0 to 30, di)

[Explanation]

What is Ramp/Soak?

This function automatically runs after setting SV and the times for the SV changes.

SV setting can be set to maximum 64 steps and Ramp/soak activation pattern can be selected from 31 patterns or by specified Di.

(Please refer to "5-10 Digital input (Di) function" regarding Di function)

Additionally, Ramp/soak status can be output from Do.

(Please refer to "5-11 Digital output (Do) function" regarding Do function)

- Ramp: Changing SV tends to reach a target SV
- Soak: Maintains a set SV

The ramp/soak menu (ch8) consists of the following function blocks.

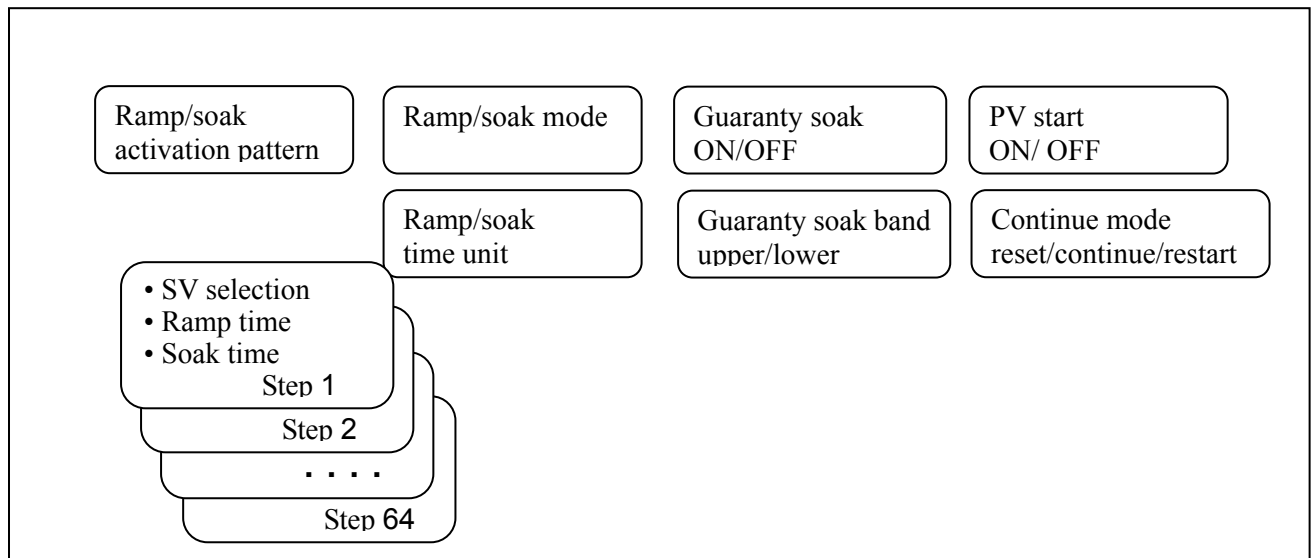
**Note**

- Even if operation is switched to remote SV operation or manual MV operation during Ramp/soak, Ramp/soak operation will not be stopped. Even Ramp/soak operation is continued and SV is kept changing, remote SV operation or manual MV operation is given first priority to.
- When operation is switched to remote SV operation during Ramp/soak and then switched to local SV operation again, SV value will be switched to Ramp/soak SV value even though SV tracking function is set to ON.

5. ADVANCED USAGE

1) PrG (Ch1-6)

- Switch between Ramp/soak states.

Ramp/soak can switch the following three conditions.

PrG	Operation status
oFF	Stop: Ramp/soak is stopped.
rUn	Run: Ramp/soak starts.
hLd	Hold: Ramp/soak hold. To release the hold, select "rUn" again.

- Parameter will be switched automatically based on Ramp/soak status.

PrG	Status
GS	Guaranty soak ON: Guaranty soak is activated and PV is out of guaranty soak setting range.
End	End: Ramp/soak ends

- "RS" ramp lights up as following during Ramp/soak

Ramp/soak status	Operation screen	others
oFF (Stop)	OFF	OFF
r Un (Run)	blinking	
hLd (Hold)	blinking	
GS (out of GS range)	blinking	
End (End)	ON	



Note

- Local SV value can not be changed during Ramp/soak operation.
When you change the local SV to given value, make sure to set PrG to "oFF" before change.

2) PTn (Ch8-1)

- Selects the Ramp/soak activation pattern.

Ramp/soak of following steps will be carried out based on Ramp/soak activation pattern setting.

PTn	Activation step	PTn	Activation step
0	1 ~ 4	16	1 ~ 8
1	5 ~ 8	17	9 ~ 16
2	9 ~ 12	18	17 ~ 24
3	13 ~ 16	19	25 ~ 32
4	17 ~ 20	20	33 ~ 40
5	21 ~ 24	21	41 ~ 48
6	25 ~ 28	22	49 ~ 56
7	29 ~ 32	23	57 ~ 64
8	33 ~ 36	24	1 ~ 16
9	37 ~ 40	25	17 ~ 32
10	41 ~ 44	26	33 ~ 48
11	45 ~ 48	27	49 ~ 64
12	49 ~ 52	28	1 ~ 32
13	53 ~ 56	29	33 ~ 64
14	57 ~ 60	30	1 ~ 64
15	61 ~ 64	di	specified by Di

Note

- When Di is selected, make sure to set to "pattern №+1 to 16" by " 5-10 digital input (Di) function" and specify the activation pattern by Di
Additionally, during Ramp/soak operation do not change the Di input status which specify Rmp/soak activation pattern.
- Do not change the PTn setting during Ramp/soak operation.
When you change the setting, make sure to set the PrG to "oFF".

3) TiMU (Ch8-2 to 2)

- Sets the time units when Ramp/soak is activated.

Max. settable time of Ramp/soak is as follows related to setting value.

TiMU	Time unit	Max. settable time
hh.MM	hour: min	99hours 59minutes
MM.SS	min: sec	99minutes 59seconds

Note

- Time units can not be set separately for each step. All steps use the same unit of time.

5. ADVANCED USAGE

- 4) Sv-1 to Sv64 TM1r to T64r TM1S to T64S (Ch8-3 toJ4)
 – Sets the target value (SV value), ramp time and soak time.
 Target value (SV value), Ramp time and soak time can be set up to 64 steps.
 Ramp time is a changing time of SV to reach target SV.
 Soak time is a duration time to maintain the setting SV.

Parameter	Setting value
Sv-1 to Sv64	"SV lower limit (S v L) to SV upper limit (S v h)"
TM1r to T64r	"00:00-99:59 (hour:min/min: sec)"
TM1S to T64S	"00:00-99:59 (hour:min/min: sec)"

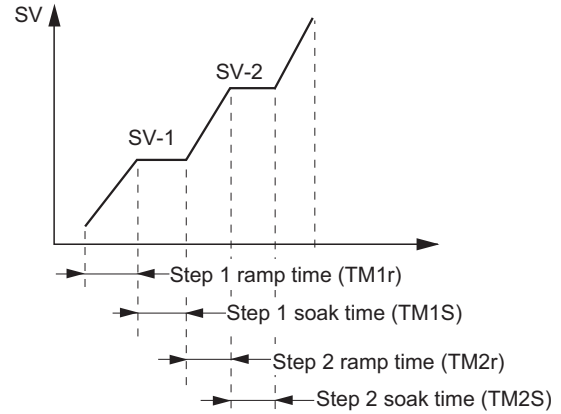

- Both ramp time (TM1r to T64r) and soak time (TM1S~T64S) skip segment 00:00 and proceed the next step.

SV-1 : 50 Sv-2 : 200 Sv-3 : 100
 TM1r : 0.10 TM2r : 0.00 TM3r : 1.00
 TM1S : 0.05 TM2S : 0.00 TM3S : 0.75

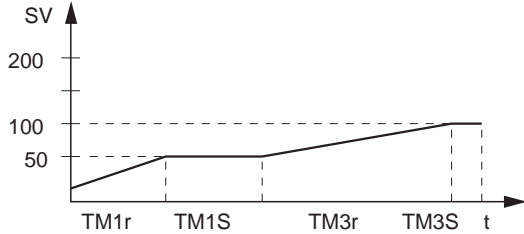

【Note】

- The SV limit function (SV-h, SV-L) is still on while ramp/soak is running.
 The set value (SV-n) does not change, but the value is limited during ramp/soak. For that reason, the value may not change at the set times for the following patterns."

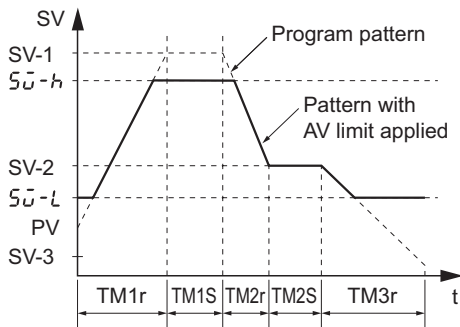

- 5) Mod (Ch8-J5)
 - Sets the method of ramp/soak operation.

Function	Description
Power-on start	Starts ramp/soak from the current PV value when the main unit is turned on.
END time output	Maintains the same state as at the end of ramp/soak when ramp/soak is complete. (It is invalid when repeat operation is activated)
oFF time output	Switches to the OFF state when ramp/soak is complete.
Repeat operation	Repeats ramp/soak from step 1 when the last step finishes.

There are 16 types of operation modes according to the combination of function as shown blow.

MOD	Power On Start	Engine Output	OFF Output	Repeat Behavior
0	none	Maintain control	Maintain control	none
1	none	Maintain control	Maintain control	on
2	none	Maintain control	Standby Mode	none
3	none	Maintain control	Standby Mode	on
4	none	Standby Mode	Maintain control	none
5	none	Standby Mode	Maintain control	on
6	none	Standby Mode	Standby Mode	none
7	none	Standby Mode	Standby Mode	on
8	on	Maintain control	Maintain control	none
9	on	Maintain control	Maintain control	on
10	on	Maintain control	Standby Mode	none
11	on	Maintain control	Standby Mode	on
12	on	Standby Mode	Maintain control	none
13	on	Standby Mode	Maintain control	on
14	on	Standby Mode	Standby Mode	none
15	on	Standby Mode	Standby Mode	on

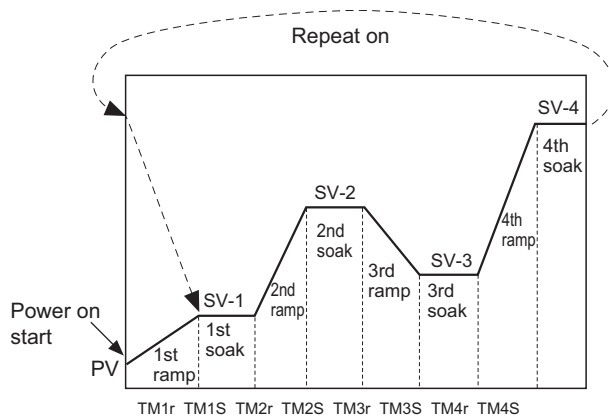

5. ADVANCED USAGE

6) Gsok (Ch8-J6) GS-h (Ch8-J7) GS-L (Ch8-J8)

- Sets the Guaranty soak ON/OFF.

Guaranty soak is the function to guarantee soak time.

Soak time is counted down only when PV is in the proper temperature range of SV setting .

In the diagram below, the total of the shaded regions are counted as soak time.

When this total is equal to the specified soak time, the cycle proceeds to the next step.

Gsok	Function
oFF	Disable guaranty soak.
on	Enable guaranty soak.

Parameter	Setting range
GS-h	0 to 50%FS
GS-L	0 to 50%FS

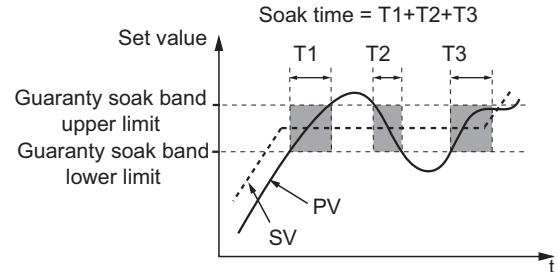

Note

- In guaranty soak, soak time is counted using by SV and PV value where are set at Sv-1 to S v 64.
- For this reason, when you set SV value lower than setting value of Sv-1to Sv64 with SV limit function, please note that soak time may not be counted.

7) PvST (Ch8-J9)

- When the ramp soak starts (RUN), this function searches the first point where the measurement value (PV) and the program pattern match, and starts operation at that point.

PvST	Function
oFF	Disables PV start function
on	Enables PV start function

Difference of starting position according to PV value

- 1) When PV is matching SV setting value in the program, it will start from Soak period of matching SV.
- 2) When PV is in a range of the SV setting value of the Ramp period, the Ramp is started on the way in the Ramp period.
- 3) When PV does not match SV in the program within the PV input range (PV is lower than SV), Ramp is started from PV value towards to the first target SV.
- 4) When the PV value does not match SV in the program within the PV input range (PV is higher than SV) or PV is an over range, it is started from the Soak period of program SV setting value MAX value.
- 5) When the PV value is under range, it is started from the Soak period of program SV setting value MIN value.

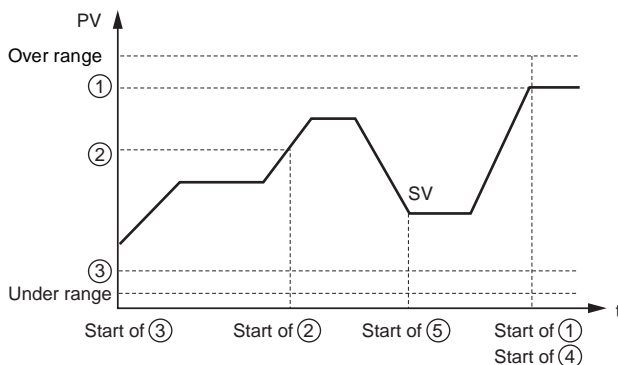

Note

- When ConT(Ch8-K0) is set to "Con", PV start is disabled.

8) ConT (Ch8-KO)

- When the power turns off during operation due to power outage or other reasons, continue mode can specify the ramp soak operation when the power turns on.
Restore the status up to 5 minutes before.

Setting value	Operation of continue mode
rES	Ramp/Soak is not be operated.
Con	Continues the operation from the status of the time which power is turned off
ini	Starts the Ramp/Soak from the first step again.

Note

- Do not change the "ConT" during Ramp/soak operation.
Make sure to change while "PrG" is set to "oFF".
- When "ConT" setting is set to "Con", PV start is disabled.
- "ConT" is set to "Con" and when outage occur, restore the status up to 5 minutes before where outage occurred.
- When "ConT" is set to "Con", do not set the Ramp/Soak command (Ch1-6) to "hoLd" frequently more than 10times/per hour.

9) PTnM (Ch8-K1) Pmin (Ch8-K2)

- Sets the max./min. pattern to proceed the Ramp/soak activation pattern with function keys.

Parameter	Setting range
PTnM	0 to 30,di
PMin	0 to 30,di

When you change this setting, make sure to set that "PTnM" (Max.value) is more than "PMin" (Min.value).

Please refer to the "5-13 Function key" regarding user key setting.

Note

- When "di" is selected by PTnM and PMin, Ramp/soak activation pattern specified by Di will be conducted after Ramp/soak activation pattern "30". Tus, when Ramp/soak activation pattern is not specified by Di, do not set the setting value to "di".

6 TROUBLESHOOTING

Symptom	Possible cause	Remedy	See (page)
1. Reading appears as UUUU or LLLL.	(1) Input signal of the sensor and settings of parameter PV1T, PV2T, or AI1T do not coincide.	Make the setting of PV1T, PV2T, and AI1T again.	29
	(2) Polarity of input signal is reversed.	Check the polarity and connect properly.	152
	(3) Short circuit occurred to the input of B or R thermocouple (PV1T, PV2T = 4, 5).	Set parameters PV1T and PV2T to 3, and check that temperature around normal temperature is displayed. (The error of B and R thermocouples is extremely large near normal temperature. It is not a failure.)	29
	(4) Input signal of the sensor and the type do not match.	Ask your distributor for modification, or replace it with a proper type unit.	—
	(5) Input connection is loose.	Fasten securely.	—
	(6) The sensor is broken or short-circuited.	Replace the sensor, or remove the short-circuited part.	152
	(7) A device connected to the sensor or the input of the main unit is defective.	Replace the sensor or input devices.	—
	(8) Parameter PV1B, PV2B, AI1B or UCB1 is set to the value larger than PV1F, PV2F, AI1F, or UCF1 respectively.	Make the setting again to assure PV1B < PV1F, PV2B < PV2F, AI1B < AI1F, and UCB1 < UCF1.	29
	(9) Measurement value is too large or too small.	Extend the setting value for parameters PV1B, PV2B, AI1B, UCB1, PV1F, PV2F, AI1F, and UCF1.	29
2. Fractional portion of the reading is not displayed.	Parameter, PV1d, PV2D, AI1D, or UCD1 is set to 0.	Set them in the range from 1 to 3.	29
3. SV and set value of some of the parameters change spontaneously.	Parameter PV1b, PV1F, or Pv1d has been changed (when TPTL=13, 14). Parameter UCB1, UCF1, or UCD1 has been changed (when TPLT=10, 11, 16).	Make the setting of all the parameters again.	153 to 165
4. ON/OFF control (2-position control) cannot be started.	Parameter P1 is not set to 0.0.	Set P1 to 0.0.	86
5. ON/OFF control does not function.	(1) Setting of parameter hS1 is not correct.	Adjust the setting of hS1 according to the control target.	87
6. Control does not function properly.	(1) Setting of parameter P1, i1, or d1 is not correct.	Do auto tuning.	48
	(2) Proportion cycle is too long.	Gradually decrease the setting of parameter TC1.	42
	(3) Output limit is posed.	Make the setting of parameters MVh1 and MVL1 to the value appropriate for the process.	84

Symptom	Possible cause	Remedy	See (page)
7. Reaction is slow. (Measurement value changes very slowly.)	Input filter is too large.	Decrease the setting of parameter P1TF. When PV2 or AI1 is used, decrease the setting of P2TF or A1TF.	82
8. Reading does not change although output is turned ON/OFF.	(1) Input is short-circuited.	Remove the short-circuited part.	—
	(2) Connection with operation terminal is off.	Connect properly.	152
	(3) Power for the operation terminal is OFF.	Set the power to ON.	—
	(4) Output signal and input signal of the operation unit do not coincide.	Provide a thermoregulator appropriate for the operation terminal, or provide operation terminal appropriate for the signals from the thermoregulator.	—
9. Key operation cannot be performed. Parameter value cannot be changed.	Parameter LOC is set to 1, 2, 4, or 5.	Set LOC to 0 or 3. (If LOC is set to 3, setting cannot be made by communication.)	90
10. SV cannot be changed.	(1) Parameter LOC is set to 1 or 4.	Set LOC to 0, 2, 3, or 5.	90
	(2) Setting of values outside the measurement range (parameters Sh1 to SL1) was attempted.	Extend the range of Sh1 and SL1. (Do not extend the range exceeding the values listed in input range table.)	47
11. Parameter to be checked or changed does not appear.	Setting has been made to skip the parameters in question with parameters ds00 to ds43.	Change the setting of the parameter in question in ds00 to ds43.	115
12. Auto tuning cannot be done properly.	(1) After auto tuning was started, input was set to UUUU.	Expand the range of parameters PV1d, PV1F, and PV1B when TPLT = 13, 14, and expand the range of parameters UCD1, UCF1, and UCB1 when TPLT = 10, 11, 16 and then do auto tuning again.	29
	(2) After auto tuning was done, SV was changed.	Restore the SV value to be controlled and then do auto tuning again.	48
	(3) Peripheral devices or connections with those devices are faulty.	Make connections with peripheral devices properly.	—
	(4) Forward/reverse operation of thermoregulator and the system of control target do not coincide.	Set parameter rEV1 properly.	44
	(5) Control target runs out of time in a very slow process (about 17 hours or longer).	Do tuning manually. (Set P1 to 0, and perform ON/OFF control.)	86
13. Overshoot is too large in auto tuning.	—	(1) Do auto tuning at ATP1 = LPV (low PV type AT).	48
	—	(2) Do tuning manually.	—
14. Decimal point cannot be changed.	TPLT has been set to 10, 11 or 16.	Set TPLT to 13 or 14, or change the decimal point of UCd1.	21 or 29

Error indications

This Controller has a display function to notify when the equipment is not functioning properly. When a problem occurs, remove the cause immediately.

Once the cause has been removed, turn the power OFF then ON again.

Display	Cause	Control output
UUUU	(1) Thermocouple sensor wire broken (2) RTD wiring broken (3) PV value above upper limit +5%FS or more (4) RCJ sensor not attached (thermocouple input)	MV (operation output) is output with the value of brd1 (ch9-35). (Output type) (1) HOLD, (2) LO (OFF or low limit value of the AO) (3) HI (ON or upper limit value of the AO) (4) EXMV
LLLL	(1) Short circuit of resistance bulb sensor (between A and B) (2) When PV value without fractional portion is under -19999. Note) In case of the resistance bulb, LLLL is not displayed even if under -150°C.	Control continues. Note) Control continues until below -5%FS. Burnout occurs at below -5%FS.
PV not displaying	Standby mode (PV display set to off)	MV (operation output) is output with the value of PMv1 (ch2-22).
-19999 or 99999	Display limit is smaller than over range or under range value.	Control continues. Note) Control continues until under -5%FS or 105%FS.
Correct PV not displayed	The main unit was not reset or the power was not turned on after scale setting was changed.	—————

7 FREQUENTLY ASKED QUESTIONS

- Q1 Decimal point of the measurement value (PV) started flickering while parameter setting was being changed. What does the decimal point at the far right mean?
A The decimal point at the far right is kept flickering while auto tuning is being performed. Set AT (Ch1-7) to OFF.
- Q2 How is temperature displayed?
A The value rounded off from the lower place value is displayed.
- Q3 Can 105°C be expressed as 60°C?
A It is possible by adjustment by the user. Display can be made in the range of $\pm 50\%$ of the full scale range.
- Q4 What kind of cables should we use for RS485?
A Use twisted pair cables with a shield. Recommended cable: KPEV-SB (By FURUKAWA)
- Q5 PV value has been stably displayed for about a week. Then it increased suddenly for 2 to 3 minutes, and returned back to the original value.
A Effect of noise is considered. Replace the cable with the one provided with a shield.
- Q6 P is set to 0.0, but ON/OFF display does not appear.
A There is no ON/OFF display. Either of the two output status of MV, 0% (OFF) or 100% (ON) is displayed.
- Q7 Key operation cannot be made.
A The instrument is provided with key lock function, but if the display does not change even if the SEL key is pressed, key failure is considered. Check the type and ask the manufacturer for repair.
- Q8 Reading error of 7 to 8°C is observed.
A The error can be adjusted by user adjustment.
- Q9 What does 50%FS (full scale) of user adjustment mean?
A Setting can be made within the range of 50% of the measurement range. Up to 200°C can be set if the measurement range is 0 to 400°C.
- Q10 MV is not output from Ao.
A Setting of OTYP (Ch8-9), which is output type selection, may have been set to 11 or 13. Set OTYP to 10 or 12.

8 SPECIFICATIONS

General specifications

General specifications

- (1) Power supply voltage:
100V (−15%) to 240V (+10%) AC, 50/60 Hz
- (2) Power consumption:
15 VA or less (100 V AC)
20 VA or less (220 V AC)
- (3) Insulation resistance:
20 MΩ or more (500 V DC)
- (4) Withstand voltage:
Power supply ↔ All terminals;
1500 V AC for 1 minute
Relay output ↔ All terminals;
1500 V AC for 1 minute
Others; 500 V AC for 1 minute

Input section

Measurement value input

- (1) Number of inputs: 1 or 2 (Option)
- (2) Input signal type:
Thermocouple: J, K, R, B, S, T, E, PR40/20, N, PL-II,
WRe5-26
Resistance bulb : Pt100Ω (3-wire)
Voltage: 0 to 10 mV DC, 0 to 5 mV DC, 0 to 10 V DC,
1 to 5 V DC, 0 to 5 V DC, 0 to 10 V DC
Current: 4 to 20 mA DC, 0 to 20 mA DC
- (3) Measurement range:
Refer to the measurement range table.
- (4) Input indication accuracy (Ambient temperature: 23°C):
· Thermocouple: (±0.1%FS ±1digit ±1°C) or ±1.5°C,
whichever is larger
Thermocouple B: 0 to 400°C range;
±5%FS±1digit±1°C
Thermocouple R: 0 to 500°C range;
±1%FS ±1digit ±1°C
· Resistance bulb input: (±0.1%FS ±1digit) or ±0.25°C,
whichever is larger
· Voltage input, current input: ±0.1%FS±1digit
- (5) Input sampling cycle: 50 ms
- (6) Input impedance
· Thermocouple, voltage input (mV): 1 MΩ or more
· Voltage input (V): 1MΩ
· Current input: 250Ω
- (7) Influence of source resistance / Permissible wiring resistance
· Thermocouple, voltage input (mV): 0.1%FS per 100Ω
· Voltage input (V): 0.1%FS per 500Ω
· Resistance bulb input: 10Ω or less (per cable)
- (8) Permissible input voltage
· Voltage (V) input: +35 V / −10 V DC
· Current input: ±25 mA DC
· Thermocouple/Resistance bulb/Voltage (mV) input:
±5 V DC
- (9) Noise reduction ratio
· Normal mode: 40 dB (50/60 Hz) or more
· Common mode: 120 dB (50/60 Hz) or more
- (10) Input value correction function (Input conditioner)
· User adjustment:
±50%FS both for zero point and span point
· Square-root extractor:
OFF or cut point from 0.0 to 125.0%
· Input filter: 0.0 to 900.0 sec for time constant.

Auxiliary analog input (Option)

- (1) Number of inputs: 1
- (2) Input signal
DC voltage: 1 to 5 V DC / 0 to 5 V DC / 0 to 10 V DC
- (3) Input accuracy: ±0.2%FS
- (4) Sampling cycle: 100 ms
- (5) Input impedance: 1 MΩ
- (6) Influence of source resistance: 0.2%FS per 500Ω
- (7) Permissible input voltage: +35 V / −10 V DC
- (8) Noise reduction ratio
· Normal mode: 40 dB (50/60 Hz)
· Common mode: 120 dB (50/60 Hz)
- (9) Input value correction function
· User adjustment:
±50%FS both for zero point and span point
· Square-root extractor:
OFF or cut point from 0.0 to 125.0%
· Input filter: 0.0 to 900.0 sec. for time constant.

Digital input (DI)

- (1) Number of points:
Basic: 4 (Di1-4)
Expansion: 5 (9 points in total at max.)
- (2) Specifications: Contact or transistor input
- (3) Contact capacity:
12 V DC, Approx. 2 mA (per point)
- (4) Detection pulse width: 200 ms or more
- (5) Function: Control mode changeover, EX-MV selection, SV changeover, Control run/standby, Auto-tuning start, Built-in timer start, Alarm latch cancel.

Math function

- (1) Kind of formula:
Select by the parameter setting.
(flow compensation, Average, Hi/Lo selector, input selector)
- (2) Operation parameter:
Analog input (PV1, PV2, Ai1),
Constant (K01 - K16)
- (3) Data type: Engineering unit (with floating point)

Output section

Control output

- (1) Number of points: 1
- (2) Type: Select one as follows.
 1. Relay contact output
 - Contact structure: SPDT contact (Do4 used)
 - Contact capacity:
220V AC / 30 V DC, 3A (Resistive load)
220V AC / 30 V DC, 1A (Inductive load)
 - Life: 100,000 operations (rated load)
 2. SSR/SSC driver output (Voltage pulse)
 - Rating: 12 V DC (10 to 15 V DC)
 - Maximum current: 20mA (provided with protection against short circuit)
 - Load resistance: 600Ω or more
 3. Current output (4 to 20 mA DC)
 - Accuracy: ±0.2%FS
 - Linearity: ±0.2%FS
 - Load resistance: 600Ω or less

Digital output

- (1) Number of points:
 - Basic: 2 (Do3, 4)
 - Expansion: Maximum 7 (9 points in total at max.)
- (2) Specifications:
 - Contact structure:
 - SPST contact (except for Do4)
 - SPDT contact (Do4)
 - Contact capacity:
 - 220 V AC / 30 V DC, 1A (Resistive load)
 - Life: 100,000 operations (rated load)
- (3) Function: Alarm output, timer output, control output (Do4)

Analog re-transmission output

- (1) Number of points: 2 at max.
- (2) Type: Current output (4 to 20 mA DC)
 - Accuracy: $\pm 0.2\%$ FS
 - Linearity: $\pm 0.2\%$ FS
 - Load resistance: 600 Ω or less
- (3) Output contents: PV, SV, MV, DV

Transmitter power supply output

- (1) Number of points: 1 at max.
- (2) Rating:
 - 24 V DC (17 to 30 V DC), Maximum current; 23 mA (with short circuit protection)

Alarm function**Number of alarm points**

- 8 points for setting

Type of alarm

- PV value (upper/lower limit, absolute/deviation, band), PV variation ratio, SV upper/lower limit, main unit error <Optional operation>
 - Hold (standby) function
 - Alarm latching
 - Excitation/non-excitation
 - Operation delay: 0 to 9999 sec, 0 to 9999 min

Alarm output

- Allocated to DO1 to DO4 and DO11 to DO15 (Allocation change available.)

Communication function**PC Loader interface**

- (1) Number of points: 1
- (2) Physical specifications: EIA RS232C
- (3) Protocol: Modbus-RTU
- (4) Communication method:
 - 3-wire, half-duplex, bit serial asynchro-nous communication
- (5) Data type, Data length:
 - 8 bits, Parity; Odd/Even/None
- (6) Communication speed:
 - 9600 bps, 19200 bps, 38400 bps
- (7) Connector: 3-pole, 2.5 mm dia. Sub-miniature jack
 - * Special cable is prepared as option.

RS-485 interface

- (1) Number of points: 1
- (2) Physical specifications: EIA RS485
- (3) Protocol: Modbus-RTU
- (4) Communication method:
 - 2-wire, half-duplex, bit serial asynchro-nous communication
- (5) Data type, Data length:
 - 8 bits, Parity; Odd/Even/None
- (6) Communication speed:
 - 9600 bps, 19200 bps, 38400 bps
- (7) Connection topology:
 - Multi-drop, Up to 31 units can be connected including master device
- (8) Communication distance:
 - 500 m max. (Total length of connection)

Display

- (1) Type: LED
- (2) Display contents
 - Measurement value display:
 - 7 segments, 5 digits (red),
 - Character height; 20 mm
 - Setting display: 7 segments, 5 digits (orange),
 - Character height; 13 mm
 - Auxiliary display:
 - 7 segments, 2 digits (orange),
 - Character height; 12 mm
 - Bar graph: 12 segments (orange)
 - Status display indicator lamp:
 - Standby, control mode (R/A/M), output, alarm

Operation and storage conditions

- (1) Ambient operating temperature: -10 to 50°C
- (2) Storage temperature: -20 to 60°C
- (3) Ambient humidity for use/storage:
 - 90% RH or less (non-condensing)
- (4) Warm-up time: 15 min. or longer

Structure

- (1) Mounting method: Panel flush mounting
- (2) External terminal: M3 screw terminal
- (3) Case
 - Material: Plastic (Flame-resistant, UL94V-0)
 - Color: Gray
- (4) Protection
 - Faceplate: IEC IP66, NEMA-4X-equivalent (When mounted on panel with our genuine packing. Waterproof feature unavailable in side-by-side mounting.)
 - Body: IEC IP20 (Provided with slits on top and bottom faces)
 - Terminal section: IEC IP00. Terminal cover can be mounted (option).
- (5) External dimension:
 - 96 (W) x 96 (H) x 81.5 (D) mm
 - * "D" is the depth from the front face of the panel (not including terminal cover).
- (6) Mass: Approx. 500 g

Appendix 1 Terminal connection diagram

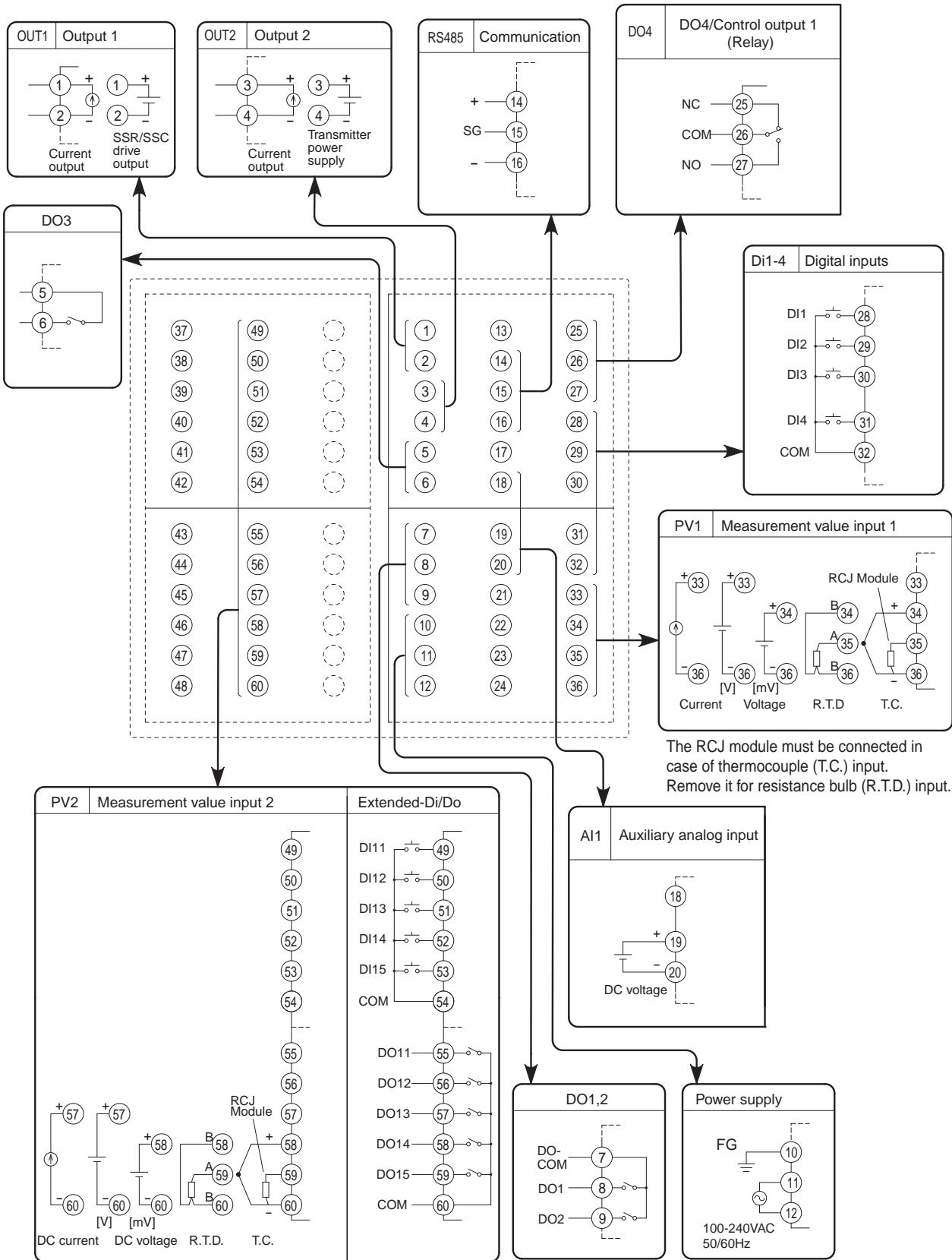

The RCJ module must be connected in case of thermocouple (T.C.) input. Remove it for resistance bulb (R.T.D.) input.

The RCJ module must be connected in case of thermocouple (T.C.) input. Remove it for resistance bulb (R.T.D.) input.

Appendix 2 Parameter list

Ch1 <i>oPE</i> (Operation parameter)							
Parameter				Content Explanation	Factory default	Parameter mask	Notes
No.	Display	Symbol	Name				
1	<i>rEM1</i>	rEM1	Remote mode	Switches setting between remote/auto mode operation. REM: Remote mode AUT: Auto mode	AUT	01-1	See 4-3.
5	<i>STbY</i>	STbY	Standby command	Switches controller to RUN/Standby. ON: Control standby (output OFF, alarm OFF) OFF: Control RUN	OFF	01-5	See 4-5.
6	<i>PrG</i>	PrG	Ramp/soak activation command	Switches between ramp/soak operation states oFF : Stop rUn : Run hLd : Hold	OFF	01-6	See 5-31.
7	<i>AT</i>	AT	Auto-tuning command	Sets auto-tuning. OFF: non-action ON1: start auto-tuning.	OFF	01-7	See 3-7.
8	<i>LACH</i>	LACH	Alarm latch clear command	Disables alarm 1 - 8 latch. OFF: non-action CLR: Latch clear	OFF	01-8	See 3-8.
9	<i>PLTn</i>	PLTn	Palette selection	Selects a PID palette to be used to control. (Setting range: 0 to 7)	0	01-10	See 5-6.
10	<i>AL1</i>	AL1	Alarm settings 1	Alarm 1 operation value setting. Setting possible within the input range	10%FS	02-1	Displayed when alarm operation type 1TP (chA-1) is set to 1 to 11. (See 3-8.)
11	<i>A1-L</i>	A1-L	Alarm lower limit settings 1	Alarm 1 lower limit operation value setting. Setting possible within the input range	10%FS	02-1	Displayed when alarm operation type 1TP (chA-1) is set to 16 to 31. (See 3-8.)
12	<i>A1-h</i>	A1-h	Alarm upper limit settings 1	Alarm 1 upper limit operation value setting. Setting possible within the input range	10%FS	02-1	Displayed when alarm operation type 1TP (chA-1) is set to 16 to 31. (See 3-8.)
31	<i>AL8</i>	AL8	Alarm settings 8	Alarm 8 operation value setting. Setting possible within the input range	10%FS	02-8	Displayed when alarm operation type 8TP (chA-36) is set to 1 to 11. (See 3-8.)
32	<i>A8-L</i>	A8-L	Alarm lower limit settings 8	Alarm 8 lower limit operation value setting. Setting possible within the input range	10%FS	02-8	Displayed when alarm operation type 8TP (chA-36) is set to 16 to 31. (See 3-8.)
33	<i>A8-h</i>	A8-h	Alarm upper limit settings 8	Alarm 8 upper limit operation value setting. Setting possible within the input range	10%FS	02-8	Displayed when alarm operation type 8TP (chA-36) is set to 16 to 31. (See 3-8.)

Ch1 <i>oPE</i> (Operation parameter)											
Parameter				Content Explanation	Factory default	Parameter mask	Notes				
No.	Display	Symbol	Name								
34	<i>LoC</i>	LoC	Keylock	Selects parameter lock type (Setting range: 0 to 5)	0	01-11	See 5-7.				
								Key operation	Communication		
				No.				All Parm.	SV/MV	All Parm.	SV/MV
				0				●	●	●	●
				1				×	×	●	●
				2				×	●	●	●
				3				●	●	×	×
				4				×	×	×	×
5	×	●	×	×							
				●: Can be set ×: Cannot be set							
35	<i>JP1</i>	JP1	Parameter jump setting 1	Press the function key (when 60 is selected), and the display jumps to the specified parameter. (Setting range: I-01 to Z-Z9)	2-01	01-12	See 5-13.				
36	<i>JP2</i>	JP2	Parameter jump setting 2	Press the function key (when 61 is selected), and the display jumps to the specified parameter. (Setting range: I-01 to Z-Z9)	2-02	01-12					
37	<i>JP3</i>	JP3	Parameter jump setting 3	Press the function key (when 62 is selected), and the display jumps to the specified parameter. (Setting range: I-01 to Z-Z9)	2-03	01-12					

Ch2 P_{id} (Control parameter)																								
No.	Parameter			Content Explanation	Factory default	Parameter mask	Notes																	
	Display	Symbol	Name																					
1	$P I$	P1	Proportional band	Setting range: 0.0 to 999.9% ON/OFF control at setting = 0.	5.0	03-1	See 5-3.																	
2	$I I$	i1	Integral time	Setting range: 0.0 to 3200.0 seconds Integral control OFF at setting = 0.	240.0	03-1																		
3	$d I$	d1	Derivative time	Setting range: 0.0 to 999.9 seconds Derivative control OFF at setting = 0.	60.0	03-1																		
5	$Arh I$	Arh1	Anti - reset windup Upper limit setting value	Integration cut point upper limit setting value (Setting range: 0 to 100%FS)	100%FS	03-3	Sets by deviation from SV. (See 5-5.)																	
6	$ArL I$	ArL1	Anti - reset windup Lower limit setting value	Integration cut point lower limit setting value (Setting range: 0 to 100%FS)	100%FS	03-3																		
7	$Sh I$	Sh1	SV value upper limit	Sets upper limit SV (Setting range: -25 to 125%FS)	100%FS	03-4	See 3-6.																	
8	$SL I$	SL1	SV value lower limit	Sets lower limit SV (Setting range: -25 to 125%FS)	0%FS	03-4																		
9	$Mvh I$	Mvh1	MV value upper limit	Sets upper limit MV (Setting range: -25.0 to 125.0%FS)	105.0	03-5	See 5-2.																	
10	$MvL I$	MvL1	MV value lower limit	Sets lower limit MV (Setting range: -25.0 to 125.0%FS)	-5.0	03-5																		
13	$dMv I$	dMv1	MV change ratio limit	Sets the limit value of deviation of MV (DMV) in one control cycle (50ms.) (Setting range: 0.0 to 150.0%) 0.0: No limit	0.0%	03-7	Limit is not applied to the deviation of MV by EX-MV operation. (See 5-2.)																	
14	$dT I$	dT1	Sampling cycle	Sets sampling cycle for PID operation. (Setting range: 5 to 1000)	5	03-8	The actual cycle is (dT1 × 10) ms. (See 5-3.)																	
15	$hS I$	hS1	Hysteresis setting	Hysteresis value during ON/OFF control time. (Setting range: 0 to 50%FS)	0.3%FS	03-9	See 5-4.																	
18	$bAL I$	bAL1	Operation output convergence value	Sets output convergence value (Setting range: -100.0 to 100.0%)	0.0%	03-12	See 5-5.																	
19	$TC I$	TC1	Cycle time of Control output (MV1)	Sets proportional cycle for control output. (Setting range: 1 to 150 sec)	By designation at the time of ordering	03-13	Effective only for RY output and SSR drive output. (See 3-5.)																	
20	$rEv I$	rEv1	Control action setting	Sets a control action NRML: Normal (Direct) action REV: Reverse action	REV	03-14	See 3-5.																	
22	$PMv I$	PMv1	Preset value for control output	Sets MV for standby mode. (Setting range: -25.0 to 125.0%)	0.0	03-16	See 4-5.																	
23	$ALP I$	ALP1	Alpha	Sets 2 degrees of freedom coefficient α . (Setting range: -300.0 to 300.0%)	40.0	40-1	See 5-23.																	
24	$bET I$	bET1	Beta	Sets 2 degrees of freedom coefficient β . (Setting range: 0.0 to 999.9%)	100.0	40-1																		
38	$Ld I$	Ld1	Output limiter type setting	Sets whether the value should be limited at the output limit setting or the limit should be exceeded (125%, 25%) when the output reaches the output limit setting. <table border="1" data-bbox="683 1742 1058 1899"> <thead> <tr> <th rowspan="2">LD1</th> <th colspan="2">Output operation</th> </tr> <tr> <th>Upper side</th> <th>Lower side</th> </tr> </thead> <tbody> <tr> <td>0</td> <td>125.0%</td> <td>-25.0%</td> </tr> <tr> <td>1</td> <td>125.0%</td> <td>Limit</td> </tr> <tr> <td>2</td> <td>Limit</td> <td>-25.0%</td> </tr> <tr> <td>3</td> <td>Limit</td> <td>Limit</td> </tr> </tbody> </table>	LD1	Output operation		Upper side	Lower side	0	125.0%	-25.0%	1	125.0%	Limit	2	Limit	-25.0%	3	Limit	Limit	3	40-1	See 5-2.
LD1	Output operation																							
	Upper side	Lower side																						
0	125.0%	-25.0%																						
1	125.0%	Limit																						
2	Limit	-25.0%																						
3	Limit	Limit																						
97	$EXM I$	EXM1	External manipulated value	Sets external output value. (Setting range: -25.0 to 125.0%)	0.0	07-1	See 5-22.																	
99	$kF I$	kF1	FF gain	Sets Feed Forward gain and bias 1, bias 2. [FF = KF1 × (Input - B1F) + B2F] (Setting range: -1000.0 to 1000.0)	0.0	40-2																		
A0	$b1F I$	b1F1	FF bias1		0.0	40-2																		
A1	$b2F I$	b2F1	FF bias2		0.0	40-2																		

Ch3 <i>PLF</i> (Control palette)							
Parameter				Content Explanation	Factory default	Parameter mask	Notes
No.	Display	Symbol	Name				
1	<i>SV1</i>	Sv1	Setting value 1	Palette 1 SV (Setting range: SV lower limit value to SV upper limit value)	0%FS	08-1	See 5-6.
2	<i>P-1</i>	P-1	Proportional band 1	Palette 1 proportional band (Setting range: 0.0 to 999.9%) ON/OFF control at setting = 0.	5.0	08-1	
3	<i>I-1</i>	i-1	Integral time 1	Palette 1 integral time (Setting range: 0.0 to 3200.0 sec) Integral control OFF at setting = 0.	240.0	08-1	
4	<i>D-1</i>	d-1	Derivative time 1	Palette 1 derivative time (Setting range: 0.0 to 999.9 sec) Derivative control OFF at setting = 0.	60.0	08-1	
6	<i>Arh1</i>	Arh1	Anti - reset windup upper limit value 1	Palette 1 Anti - reset windup upper limit value setting. (Setting range: 0 to 100%FS)	100%FS	08-1	
7	<i>ArL1</i>	ArL1	Anti - reset windup lower limit value 1	Palette 1 Anti - reset windup lower limit value setting. (Setting range: 0 to 100%FS)	100%FS	08-1	
8	<i>hYS1</i>	hYS1	Hysteresis setting 1	Palette 1 hysteresis setting (Setting range: 0 to 50%FS)	0.3%FS	08-1	
11	<i>bL-1</i>	bL-1	Output convergence value 1	Palette 1 Output convergence value (Setting range: -100.0 to 100.0%)	0.0%	08-1	
}							
67	<i>SV7</i>	Sv7	Setting value 7	Palette 7 SV (Setting range: SV lower limit value to SV upper limit value)	0%FS	14-1	See 5-6.
68	<i>P-7</i>	P-7	Proportional band 7	Palette 7 proportional band (Setting range: 0.0 to 999.9%) ON/OFF control at setting = 0.	5.0	14-1	
69	<i>I-7</i>	i-7	Integral time 7	Palette 7 integral time (Setting range: 0.0 to 3200.0 sec) Integral control OFF at setting = 0.	240.0	14-1	
70	<i>D-7</i>	d-7	Derivative time 7	Palette 7 derivative time (Setting range: 0.0 to 999.9 sec) Derivative control OFF at setting = 0.	60.0	14-1	
72	<i>Arh7</i>	Arh7	Anti - reset windup upper limit value 7	Palette 7 Anti - reset windup upper limit value setting. (Setting range: 0 to 100%FS)	100%FS	14-1	
73	<i>ArL7</i>	ArL7	Anti - reset windup lower limit value 7	Palette 7 Anti - reset windup lower limit value setting. (Setting range: 0 to 100%FS)	100%FS	14-1	
74	<i>hYS7</i>	hYS7	Hysteresis setting 7	Palette 7 hysteresis setting (Setting range: 0 to 50%FS)	0.3%FS	14-1	
77	<i>bL-7</i>	bL-7	Output convergence value 7	Palette 7 Output convergence value (Setting range: -100.0 to 100.0%)	0.0%	14-1	
78	<i>rEF1</i>	rEF1	PID switch point 1	Palette 1 PID switch point (Setting range: -25 to 125%FS)	0%FS	08-1	See 5-6.
}							
84	<i>rEF7</i>	rEF7	PID switch point 7	Palette 7 PID switch point (Setting range: -25 to 125%FS)	0%FS	14-1	See 5-6.

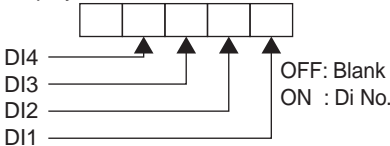
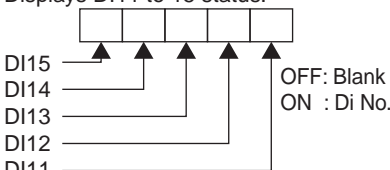
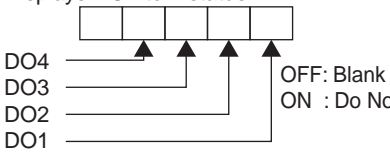
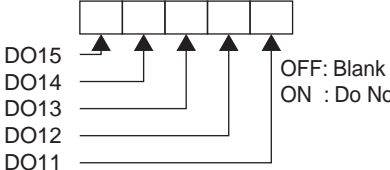
Ch7 Non (Monitor)				Content Explanation	Factory default	Parameter mask	Notes
No.	Display	Symbol	Name				
1	PV1	Pv1	PV1 monitor	Displays Process value 1 input.	-	17-1	See 4-6
2	PV2	Pv2	PV2 monitor	Displays Process value 2 input.	-	17-2	
4	AI1	Ai1	AI1 monitor	Displays Analog input 1 input.	-	17-5	
6	rSV1	rSv1	RSV1 monitor	Displays Remote set value 1.	-	17-9	
10	LSV1	LSV1	Local SV1 monitor	Display Local set value 1	-	17-9	
14	RCJ1	RCJ1	RCJ1 monitor	Displays RCJ1 input.	-	17-1	
15	RCJ2	RCJ2	RCJ2 monitor	Displays RCJ2 input.	-	17-2	
17	AO1	Ao1	AO1 monitor	Displays Analog output 1 output value.	-	18-1	
18	AO2	Ao2	AO2 monitor	Displays Analog output 2 output value.	-	18-1	
21	dI01	Di01	DI monitor 1	Displays DI1 to 4 status. 	-	19-1	
22	dI11	Di11	DI monitor 2	Displays DI11 to 15 status. 	-	19-1	
24	do01	DO01	DO monitor 1	Displays DO1 to 4 status. 	-	19-1	
25	do11	DO11	DO monitor 2	Displays DO11 to 15 status. 	-	19-1	
27	ACR	AiM	Math result monitor	Displays result of Math operation.	-	19-3	
28	TM1	TM1	Alarm delay remaining time monitor	Displays the remaining time for the alarm delay of ALM1 to ALM8.	-	34-1	
29	TM2	TM2				34-2	
30	TM3	TM3				34-3	
31	TM4	TM4				34-4	
32	TM5	TM5				34-5	
33	TM6	TM6				34-6	
34	TM7	TM7				34-7	
35	TM8	TM8				34-8	
36	AMV1	AMV1	EXMV monitor	Displays the value to be output as EXMV.	-	17-9	
40	FFV1	FFV1	Feed Forward value	Displays the value of Feed Forward element.	-	17-9	

Ch7 Non (Monitor)							
Parameter				Content Explanation	Factory default	Parameter mask	Notes
No.	Display	Symbol	Name				
100		DiC1	Communication Di monitor (1-5)	Displays the status of communication Di1-5. Communication Di5 Communication Di4 Communication Di3 Communication Di2 Communication Di1	-	19-4	See 5-28
101		DiC2	Communication Di monitor (6-8)	Displays the status of communication Di6-8. Communication Di8 Communication Di7 Communication Di6	-	19-4	
A2		STAT	Display of Ramp/soak activation	Displays the Ramp/soak running status oFF : Ramp/soak is stopped 1-rP : Step1 during ramp 1-Sk : Step1 during soak ... 64rP : Step64 during ramp 64Sk : Step64 during soak End : Ramp/soak end	-	15-1	See 5-31
A3		rSTM	Ramp/soak elapsed time	Displays the elapsed time of segment during Ramp/soak 00:00 to 99:59 (hour : min / min : sec)	-	15-2	
A4		PTno	Current pattern No.	Displays the pattern No. of the ramp soak currently selected. 0 to 30	-	15-3	
A5		DIPT	Current pattern No. selected by DI	Displays the pattern No. of the ramp soak currently selected 0 to 30	-	15-4	
A6		rSV	Display the SV value which is result from Ramp/soak calculation	Displays the SV value which is result from Ramp/soak calculation. 0 to 100%FS	-	15-5	

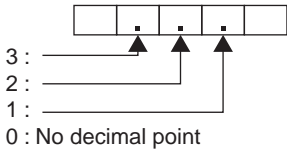
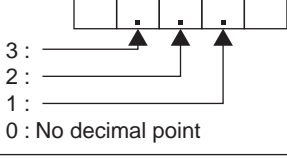
Ch8 <i>SET</i> (Input/output definition)				Content Explanation	Factory default	Parameter mask	Notes
Parameter							
No.	Display	Symbol	Name				
1	<i>P₁F</i>	Pv1F	PV1 full-scale	Sets the full-side scale of PV1 input. (Setting range: -19999 to 99999)	As ordered	20-1	See 3-2.
2	<i>P₁b</i>	Pv1b	PV1 base scale	Sets the base-side scale of PV1 input. (Setting range: -19999 to 99999)	As ordered	20-1	
3	<i>P₁d</i>	Pv1d	PV1 decimal point position	Specifies the decimal point position of PV1 input. (Setting range: 0 to 3) 	As ordered	20-1	
4	<i>P₁T</i>	Pv1T	PV1 input type	Sets the type of PV1 input. (Setting range: 0 to 27)	As ordered	20-1	See 5-9.
5	<i>P₁U</i>	Pv1U	PV1 unit	Sets the measurement unit. non : No unit °F : °F unit °C : °C unit	As ordered	20-2	
6	<i>P₁Z</i>	Pv1Z	PV1 input zero point adjustment	Sets the correction value of a zero point for PV1 input. (Setting range: -50 to 50%FS)	0%FS	20-3	
7	<i>P₁S</i>	Pv1S	PV1 input span point adjustment	Sets the correction value of a span point for PV1 input. (Setting range: -50 to 50%FS)	0%FS	20-3	See 5-1.
11	<i>P₁CU</i>	P1CU	PV1 input cut point	Sets the cut point of square-root extraction calculation for PV1 input. In case of OFF, the square-root extraction is not calculated. (Setting range: OFF, 0.0 to 125.0%)	OFF	20-7	
12	<i>P₁FF</i>	P1TF	PV1 input filter	Sets the time constant for PV1 input filter. (Setting range: 0.0 to 900.0 sec)	0.0	20-8	
13	<i>P₁Ln</i>	P1Ln	PV1 linearize setting	PV1 input linearize enable/disable setting (Setting range: OFF, nrML, hi-C, Lo-C)	OFF	20-9	See 5-27.
14	<i>P₂F</i>	Pv2F	PV2 full-scale	Sets the full-side scale of PV2 input. (Setting range: -19999 to 99999)	As ordered	20-1	See 3-2.
15	<i>P₂b</i>	Pv2b	PV2 base scale	Sets the base-side scale of PV2 input. (Setting range: -19999 to 99999)	As ordered	20-1	
16	<i>P₂d</i>	Pv2d	PV2 decimal point position	Specifies the decimal point position of PV2 input. (Setting range: 0 to 3) 	1	20-1	
17	<i>P₂T</i>	Pv2T	PV2 input type	Sets the type of PV2 input. (Setting range: 0 to 27)	3	20-1	See 5-9.
18	<i>P₂U</i>	Pv2U	PV2 unit	Sets the measurement unit for PV2 input. non : No unit °F : °F unit °C : °C unit	°C	20-2	
19	<i>P₂Z</i>	Pv2Z	PV2 input zero point adjustment	Sets the correction value of a zero point for PV2 input. (Setting range: -50 to 50%FS)	0%FS	20-3	
20	<i>P₂S</i>	Pv2S	PV2 input span point adjustment	Sets the correction value of a span point for PV2 input. (Setting range: -50 to 50%FS)	0%FS	20-3	See 5-1.
24	<i>P₂CU</i>	P2CU	PV2 input cut point	Sets the cut point of square-root extraction calculation for PV2 input. In case of OFF, the square-root extraction is not calculated. (Setting range: OFF, 0.0 to 125.0%)	OFF	20-7	
25	<i>P₂FF</i>	P2TF	PV2 input filter	Sets the time constant for PV2 input filter. (Setting range: 0.0 to 900.0 sec)	0.0	20-8	

Note) Be sure to reset or turn on the power after parameter setting is changed.

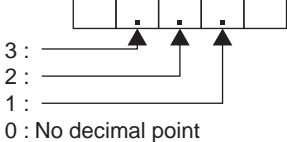
Ch8 SET (Input/output definition)							
Parameter				Content Explanation	Factory default	Parameter mask	Notes
No.	Display	Symbol	Name				
26	<i>P2Ln</i>	P2Ln	PV2 linearize setting	PV2 input linearize enable/disable setting (Setting range: OFF, nrML, hi-C, Lo-C)	OFF	21-9	See 5-27.
40	<i>ALIF</i>	Ai1F	Ai1 full scale	Sets the full-side scale of analog (Ai1) input. (Setting range: -19999 to 99999)	As ordered	23-1	See 3-2.
41	<i>ALib</i>	Ai1b	Ai1 base scale	Sets the scale of base-side analog (Ai1) input. (Setting range: -19999 to 99999)	As ordered	23-1	
42	<i>ALId</i>	Ai1d	Ai1 decimal point position	Specifies the decimal point position for analog (Ai1) input. (Setting range: 0 to 3)  <p>3 : ———▲——— 2 : ———▲——— 1 : ———▲——— 0 : No decimal point</p>	1	23-1	
43	<i>ALIT</i>	Ai1T	Ai1 input type	Sets the type of Ai1 input. (Setting range: 16 to 18)	16	23-1	
45	<i>ALIZ</i>	Ai1Z	Ai1 input zero point adjustment	Sets the correction value of a zero point for Ai1 input. (Setting range: -50 to 50%FS)	0%FS	23-3	See 5-9.
46	<i>ALIS</i>	Ai1S	Ai1 input span point adjustment	Sets the correction value of a span point for Ai1 input. (Setting range: -50 to 50%FS)	0%FS	23-3	
49	<i>ALCU</i>	A1CU	Ai1 input cut point	Sets the cut point of the square-root extraction calculation for Ai1 input. In case of OFF, the square-root extraction is not calculated. (Setting range: OFF, 0.0 to 125.0%)	OFF	23-7	See 5-1.
50	<i>ALFF</i>	A1TF	Ai1 input filter	Sets the time constant for Ai1 input filter. (Setting range: 0.0 to 900.0sec)	0.0	23-8	
51	<i>ALLn</i>	A1Ln	Ai1 linearize setting	Ai1 input linearize enable/disable setting (Setting range: OFF, nrML, hi-C, Lo-C)	OFF	23-9	See 5-27.
64	<i>AOIT</i>	Ao1T	AO1 output type	Switches the AO1 (re-transmission output) signal. Setting range: PV, SV, MV, DV, AiM, MVRB, TV	PV	25-1	See 3-9.
66	<i>AOIH</i>	Ao1h	AO1 output scale upper limit	Sets the scale upper limit value of the AO1 output. (Setting range: -130.0 to 130.0%)	100.0%	25-1	
67	<i>AOIL</i>	Ao1L	AO1 output scale lower limit	Sets the scale lower limit value of the AO1 output. (Setting range: -130.0 to 130.0%)	0.0%	25-1	
68	<i>AILH</i>	A1Lh	AO1 output limit upper limit	Sets the upper limit value of the AO1 output limit. (Setting range: -25.0 to 105.0%)	105.0%	25-1	
69	<i>AILL</i>	A1LL	AO1 output limit lower limit	Sets the lower limit value of the AO1 output limit. (Setting range: -25.0 to 105.0%)	-5.0%	25-1	
70	<i>AO2T</i>	Ao2T	AO2 output type	Switches the AO2 (re-transmission output) signal. Setting range: PV, SV, MV, DV, AiM, MVRB, TV	PV	25-2	
72	<i>AO2H</i>	Ao2h	AO2 output scale upper limit	Sets the scale upper limit value of the AO2 output. (Setting range: -130.0 to 130.0%)	100.0%	25-2	
73	<i>AO2L</i>	Ao2L	AO2 output scale lower limit	Sets the scale lower limit value of the AO2 output. (Setting range: -130.0 to 130.0%)	0.0%	25-2	
74	<i>A2LH</i>	A2Lh	AO2 output limit upper limit	Sets the upper limit value of the AO2 output limit. (Setting range: -25.0 to 105.0%)	105.0%	25-2	
75	<i>A2LL</i>	A2LL	AO2 output limit lower limit	Sets the lower limit value of the AO2 output limit. (Setting range: -25.0 to 105.0%)	-5.0%	25-2	

Note) Be sure to reset or turn on the power after the parameter setting is changed.

Ch8 <i>SET</i> (Input/output definition)							
Parameter				Content Explanation	Factory default	Parameter mask	Notes
No.	Display	Symbol	Name				
88	<i>CALC</i>	CALC	Calculation setting	Math function type setting. (Setting range: 0 to 40)	0	25-9	See 5-14.
89	<i>UCF1</i>	UCF1	Math function full scale	Sets the scale on the full side which is utilized for mathematical calculations. (Setting range: -19999 to 99999)	As ordered	25-9	
90	<i>UCb1</i>	UCb1	Math function base scale	Sets the scale on the base side which is utilized for mathematical calculations. (Setting range: -19999 to 99999)	As ordered	25-9	
91	<i>UCd1</i>	UCd1	Math function decimal point position	Sets the decimal point position for mathematical calculations. (Setting range: 0 to 3)	1	25-9	
92	<i>TPLT</i>	TPLT	Template	Specifies the template. The range of effective setting. 10 : Single-loop basic PID control (with Math function) 11 : Single-loop SV selection PID control (with Math function) 13 : Single-loop basic PID control 14 : Single-loop SV selection PID control 16 : Single-loop input selection PID control (with Math function) Setup other than the above is forbidden.	13	25-10	See 3-1.
93	<i>oTYP</i>	oTYP	Output type	Selects the control output selector type. (Setting range: 10 to 13)	As ordered	25-11	See 3-3.
98	<i>Cn01</i>	CN01	System constant 1	Sets a constant value used for templates. The meaning of the value varies depending on template. Make the setting after checking the description of each template. (Setting range: -19999 to 99999)	As ordered	25-15	
b3	<i>Cn16</i>	CN16	System constant 16				

Note) Be sure to reset or turn on the power after the parameter setting is changed.

Ch9 545 (System definition)							
Parameter				Content Explanation	Factory default	Parameter mask	Notes
No.	Display	Symbol	Name				
1	PAS1	PAS1	Password 1	Sets security (passwords). (Setting range: 0000 to FFFF)	0000	26-1	See 5-20.
2	PAS2	PAS2	Password 2	Sets security (password). (Setting range: 0000 to FFFF)	0000	26-2	
3	PAS3	PAS3	Password 3	Sets security (password). (Setting range: 0000 to FFFF)	0000	26-3	
7	rCh1	rih1	Remote mode inhibiting	Prevents switching to the REMOTE mode. (Setting range: ON/OFF)	OFF	27-1	See 5-15.
11	rAC1	rAC1	R_ACK use selection	Selects use or non-use of R_ACK. (Setting range: INH, ENA)	INH	27-5	See 5-16.
15	A-M1	A-M1	A/M mode	Selects the A/M mode. (Setting range: A-M, A)	A-M	27-9	See 5-17.
19	Cnd1	Cnd1	Mode settings when the power turns ON.	Sets the mode when the power turns ON. (Setting range: A, R, M)	A	28-1	See 5-18.
23	Trk1	Trk1	Tracking method selection (SV)	Selects ON or OFF for tracking the local set value (SV)	ON	28-9	See 5-19.
30	STBo	STBo	Operation settings when in standby mode	Sets the front display operation in the standby mode. (Setting range: 0: lighting, 1: extinction)	0	29-4	See 4-5.
31	PLTS	PLTS	Palette switching method selection	Selects a palette switching factor. (Setting range: PLTn, SV, PV)	PLTn	29-6	See 5-6.
32	F1	F1	User designation key-1 (F1)	Sets user assignments for function keys. [F1] - [F3]. (Setting range: 0 - 72)	0	29-7	See 5-13.
33	F2	F2	User designation key-2 (F2)		0	29-8	
34	F3	F3	User designation key-3 (F3)		0	29-9	
35	brd1	brd1	Burnout direction specification (MV1)	Specifies the direction of the control output during a burnout. (Setting range: HOLD, LO, UP, EXMV)	Lo	30-1	See 5-8.
39	di01	di01	Assignment for digital input 1	Sets assignments for DI1-DI4, DI11-DI15. (Setting range: 0 - 178)	di01 : 60 di02 : 70 di03 : 0 di04 : 103	31-1	See 5-10.
42	di04	di04	Assignment for digital input 4				
43	di11	di11	Assignment for digital input 11		0	31-2	
47	di15	di15	Assignment for digital input 15				
53	do1	do1	Assignment for digital output 1	Sets assignments for DO1-DO4, DO11-DO15. (Setting range: 0 - 427)	do1 : 1 do2 : 2 do3 : 3 do4 : 4	31-9	See 5-11.
56	do4	do4	Assignment for digital output 4				
57	do11	do11	Assignment for digital output 11		0	31-10	
61	do15	do15	Assignment for digital output 15				

Note) Be sure to reset or turn on the power after the parameter setting is changed.

Ch9 545 (System definition)							
Parameter				Content Explanation	Factory default	Parameter mask	Notes
No.	Display	Symbol	Name				
67		C1	LED C1 assignment	Allocates indicator LEDs. (Setting range: 0 to 427)	21	32-1	See 5-12.
68		C2	LED C2 assignment		22	32-2	
69		Ldo1	LED DO1 assignment		Ldo1 : 1	32-3	
70		Ldo2	LED DO2 assignment		Ldo2 : 2	32-4	
71		Ldo3	LED DO3 assignment		Ldo3 : 3	32-5	
72		Ldo4	LED DO4 assignment	Ldo4 : 4	32-6		
73		Ldo5	LED DO5 assignment	Ldo5 : 0	32-7		
74		LALM	LED ALM assignment		17	32-8	
79		odSP	Operation display setting	Sets display items during operation. (Setting range: 000 to 111) 	000	32-15	See 5-24.
80		dS00	Parameter mask setting	Skips (not display) unnecessary parameters.	-	0-1	See 5-21.
C3		dS43				0-15	
E3		rES	Reset command	Resets the main unit. ON : Reset OFF : RUN	OFF	33-1	See 3-4.

Note) Be sure to reset or turn on the power after parameter setting is changed.

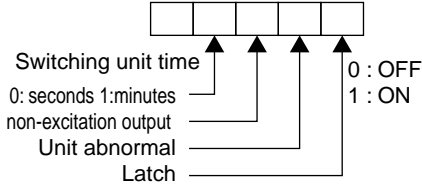
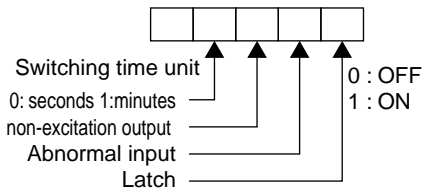
ChA ALN (Alarm setting)							
Parameter				Content Explanation	Factory default	Parameter mask	Notes
No.	Display	Symbol	Name				
1	<i>1rP</i>	1TP	Alarm 1 type setting	Sets the alarm type for alarm 1. (Setting range: 0 to 38)	0	34-1	See 3-8.
2	<i>1oP</i>	1oP	Alarm 1 option setting	Sets alarm options for alarm 1. (Setting range: 0000 to 1111) 	0000	34-1	
3	<i>1hYS</i>	1hYS	Alarm 1 hysteresis setting	Sets alarm hysteresis for alarm 1. (Setting range: 0.00 to 50.00%FS)	0.3%FS	34-1	
4	<i>1dLY</i>	1dLY	Alarm 1 delay time setting	Sets delay time for alarm 1. (Setting range: 0 to 9999) * Sets alarm options for time units. The unit of time is selected by alarm options.	0	34-1	
}							
36	<i>8rP</i>	8TP	Alarm 8 type setting	Sets the alarm type for alarm 8. (Setting range: 0 to 38)	0	34-8	See 3-8.
37	<i>8oP</i>	8oP	Alarm 8 option setting	Sets alarm options for alarm 8. (Setting range: 0000 to 1111) 	0000	34-8	
38	<i>8hYS</i>	8hYS	Alarm 8 hysteresis setting	Sets alarm hysteresis for alarm 8. (Setting range: 0.00 to 50.00%FS)	0.3%FS	34-8	
39	<i>8dLY</i>	8dLY	Alarm 8 delay time setting	Sets delay time for alarm 8. (Setting range: 0 to 9999) * Sets alarm options for time units. The unit of time is selected by alarm options.	0	34-8	

ChB <i>Con</i> (Communication)																			
Parameter				Content Explanation	Factory default	Parameter mask	Notes												
No.	Display	Symbol	Name																
2	<i>STn4</i>	STn4	RS485 station No.	Specifies RS485 communication station No. (Setting range: 0 to 255) * does not operate with STn4=0.	1	36-2	See 3-10.												
3	<i>SPd4</i>	SPd4	RS485 communication speed	Selects communication speed for RS485 communication. (Setting range) 96 : 9600 bps 192 : 19200 bps 384 : 38400 bps	384	36-3													
4	<i>biT4</i>	biT4	RS485 bit format	Selects bit format for RS485 communication. (Setting range) <table border="1" style="display: inline-table; vertical-align: middle;"> <thead> <tr> <th></th> <th>Data length</th> <th>Parity</th> </tr> </thead> <tbody> <tr> <td>8n</td> <td>8</td> <td>None</td> </tr> <tr> <td>8o</td> <td>8</td> <td>Odd</td> </tr> <tr> <td>8E</td> <td>8</td> <td>Even</td> </tr> </tbody> </table>		Data length		Parity	8n	8	None	8o	8	Odd	8E	8	Even	8o	36-4
	Data length	Parity																	
8n	8	None																	
8o	8	Odd																	
8E	8	Even																	
7	<i>SPd2</i>	SPd2	PC Loader communication speed	Selects the communication speed for PC Loader communication. (Setting range) 96 : 9600 bps 192 : 19200 bps 384 : 38400 bps	384	36-9													
8	<i>biT2</i>	biT2	PC Loader bit format	Selects the bit format for PC Loader communication. (Setting range) <table border="1" style="display: inline-table; vertical-align: middle;"> <thead> <tr> <th></th> <th>Data length</th> <th>Parity</th> </tr> </thead> <tbody> <tr> <td>8n</td> <td>8</td> <td>None</td> </tr> <tr> <td>8o</td> <td>8</td> <td>Odd</td> </tr> <tr> <td>8E</td> <td>8</td> <td>Even</td> </tr> </tbody> </table>		Data length	Parity	8n	8	None	8o	8	Odd	8E	8	Even	8o	36-10	
	Data length	Parity																	
8n	8	None																	
8o	8	Odd																	
8E	8	Even																	
51	<i>CC01</i>	Ci01	Communication Di1 function setting	Sets the function of communication Di1.	0	36-16	See 5-28.												
52	<i>CC02</i>	Ci02	Communication Di2 function setting	Sets the function of communication Di2.	0	36-16													
53	<i>CC03</i>	Ci03	Communication Di3 function setting	Sets the function of communication Di3.	0	36-16													
54	<i>CC04</i>	Ci04	Communication Di4 function setting	Sets the function of communication Di4.	0	36-16													
55	<i>CC05</i>	Ci05	Communication Di5 function setting	Sets the function of communication Di5.	0	36-16													
56	<i>CC06</i>	Ci06	Communication Di6 function setting	Sets the function of communication Di6.	0	36-16													
57	<i>CC07</i>	Ci07	Communication Di7 function setting	Sets the function of communication Di7.	0	36-16													
58	<i>CC08</i>	Ci08	Communication Di8 function setting	Sets the function of communication Di8.	0	36-16													

Note) Be sure to reset or turn on the power after parameter setting is changed.

ChC L_{nr} (Linearize)							
Parameter				Content Explanation	Factory default	Parameter mask	Notes
No.	Display	Symbol	Name				
1	$P1X0$	P1X0	Linearize table P1X0	Linearize table X0 for PV1 input (Setting range: -25% to 125%FS)	-25%FS	37-1	See 5-27.
}							
32	$P1YF$	P1YF	Linearize table P1YF	Linearize table YF for PV1 input (Setting range: -25% to 125%FS)	125%FS	37-1	
33	$P2X0$	P2X0	Linearize table P2X0	Linearize table X0 for PV2 input (Setting range: -25% to 125%FS)	-25%FS	37-2	
}							
64	$P2YF$	P2YF	Linearize table P2YF	Linearize table YF for PV2 input (Setting range: -25% to 125%FS)	125%FS	37-2	
97	$A1X0$	A1X0	Linearize table A1X0	Linearize table X0 for Ai1 input (Setting range: -25% to 125%FS)	-25%FS	37-4	
}							
128	$A1YF$	A1YF	Linearize table A1YF	Linearize table YF for Ai1 input (Setting range: -25% to 125%FS)	125%FS	37-4	

ChD LL (Calculation constant)							
Parameter				Content Explanation	Factory default	Parameter mask	Notes
No.	Display	Symbol	Name				
1	$k01$	k01	Constant for Math function	Sets the constant used for mathematical expressions.	0.0000	38-1	See 5-14.
}	}	}				38-4	
16	$k16$	k16					

ChE AT (Tuning)							
Parameter				Content Explanation	Factory default	Parameter mask	Notes
No.	Display	Symbol	Name				
1	$ATP1$	ATP1	Auto tuning type	Specifies the auto-tuning method. (Setting range) NRML : Standard type AT LPV : Low PV type AT	NRML	39-1	See 3-7.

ChG <i>r o f</i> (Totalizer)							
Parameter				Content Explanation	Factory default	Parameter mask	Notes
No.	Display	Symbol	Name				
1	<i>r r Un</i>	TrUn	Totalizer command/status	Control the totalizer. (Setting range: HoLd/rUn/LATcH)	HOLD	45-1	See 5-25.
2	<i>r r ES</i>	TrES	Totalizer reset command	Resets totalizer. (on/oFF)	oFF	45-1	
3	<i>r o In</i>	ToIn	Totalizer input selection	Selects input used for totalizer. (Setting range: Pv1, Pv2, Ai1, AiM) * Math function scale (Ch8-89, 90, 91) is adopted when "(3) AiM" is selected.	Pv1	45-2	
4	<i>r d P</i>	TdP	Totalizer decimal point position	Sets decimal point position of totalized value. (Setting range: 0 to 4)	0	45-3	
5	<i>r c U r</i>	TCUT	Totalizer input cut point	Sets the cut point for totalizer input. The input lower than the cut point is not added. (Setting range: 0% to 100%FS)	0%FS	45-4	
6	<i>R 1 r P</i>	A1TP	Totalizer alarm 1 type	Sets alarm type of totalizer alarm 1. Setting range: 0: No alarm 1: Totalize value alarm 2: Batch control output 3: Batch control output (with auto reset)	0	45-5	
7	<i>R 1 o n</i>	A1on	Totalizer alarm 1 ON pulse width	Sets ON pulse width for batch control output for totalizer alarm 1. Setting range: 0: Continue 1: 100ms 2: 200ms 3: 500ms 4: 1 sec.	0	45-5	
8	<i>R 1 o P</i>	A1oP	Totalizer alarm 1 option setting	Sets excitation/non-excitation option for totalizer alarm 1 (Setting range: 0: Excitation, 1; Non-excitation)	0	45-3	
9	<i>R 2 r P</i>	A2TP	Totalizer alarm 2 type	Sets alarm type of totalizer alarm 2. Setting range: 0: No alarm 1: Totalize value alarm 2: Batch control output 3: Batch control output (with auto reset)	0	45-6	
10	<i>R 2 o n</i>	A2on	Totalizer alarm 2 ON pulse width	Sets ON pulse width for batch control output for totalizer alarm 2. Setting range: 0: Continue 1: 100ms 2: 200ms 3: 500ms 4: 1 sec.	0	45-6	
11	<i>R 2 o P</i>	A2oP	Totalizer alarm 2 option setting	Sets excitation/non-excitation option of totalizer alarm 2. (Setting range: 0; Excitation, 1; Non-excitation)	0	45-6	
12	<i>r n o d</i>	TMod	Operation mode	Selects operation mode from Japanese and English modes. [Japanese mode] Calculation is made using totalizer conversion factor. [English mode] Calculation is made based on time base time and scaling value. Setting range: (0) JPr: Japanese mode (1) EnG: English mode	EnG	45-7	

ChG <i>r o f</i> (Totalizer)							
Parameter				Content Explanation	Factory default	Parameter mask	Notes
No.	Display	Symbol	Name				
13	<i>r o P f</i>	ToPT	Totalizer option setting	(bit setting: 0000 to 1111) 0bit: Sets flickering of the totalized value at the occurrence of totalized value over. (Totalize is suspended while the display flickers.) 1bit: Totalizer operation at standby 0: Continue, 1: Stop 2bit: Command at power ON 0: Stop, 1: Start 3bit: Totalizer operation at the occurrence of erroneous input 0: Add, 1: Not add	0011	45-8	See 5-25.
14	<i>r b</i>	Tb	Totalizer time base	Sets reference unit time for totalize. (Setting range: SEC, Min, hour, dAY)	hoUr	45-9	
15	<i>SCL</i>	SCL	Totalizer scaling value	Divisor for totalizer input value scale conversion Note: Addition is not performed when 0 is selected. (Setting range: 0 to ±1000000)	1	45-9	
16	<i>MUL</i>	MUL	Input multiplier	Multiplier for input value scale conversion (Setting range 0 to ±1000000)	1	45-9	
17	<i>r c f</i>	TCF	Totalizer conversion factor	Totalized value display when 100% input is continued for 1 hour (Setting range: 20 to 9999999. The decimal point appears according to TdP setting.)	10000	45-10	
18	<i>r c n f</i>	TinT	Totalizer initial value	The following relation holds when the value different from the current setting is selected as the initial value of totalizer. Totalized value = Initial value of totalizer (Setting range: 1999999 to 9999999. The decimal point appears according to TdP setting.)	0	45-11	
19	<i>A 1 S P</i>	A1SP	Totalizer alarm 1 setting	Sets the operation value of totalizer alarm 1. (Setting range: 1999999 to 9999999. The decimal point appears according to TdP setting.)	10000	45-5	
20	<i>A 2 S P</i>	A2SP	Totalizer alarm 2 setting	Sets the operation value of totalizer alarm 2. (Setting range: 1999999 to 9999999. The decimal point appears according to TdP setting.)	10000	45-6	
21	<i>r r S C</i>	rTSc	Re-transmission output scale	Sets the totalized value that allows re-transmission output to be 100%. (Setting range: 1999999 to 9999999. The decimal point appears according to TdP setting.)	10000	45-12	

ChH r_5 (Ramp/soak)							
Parameter				Content Explanation	Factory default	Parameter mask	Notes
No.	Display	Symbol	Name				
1	Pf_n	PTn	Ramp/soak activation pattern	Sets up which step will be used for Ramp/soak. 0: 1-4 1: 5-8 2: 9-12 3: 13-16 4: 17-20 5: 21-24 6: 25-28 7: 29-32 8: 33-36 9: 37-40 10: 41-44 11: 45-48 12: 49-52 13: 53-46 14: 57-60 15: 61-64 16: 1-8 17: 9-16 18: 17-24 19: 25-32 20: 33-40 21: 41-48 22: 49-56 23: 57-64 24: 1-16 25: 17-32 26: 33-48 27: 49-64 28: 1-32 29: 33-64 30: 1-64 di: according to DI	0	15-6	See5-31
2	r_{TNU}	TiMU	Ramp/soak time units	Sets the units used when setting the ramp/soak time hh.MM (hour : min) MM.SS (min : sec)	hh.MM (0)	15-7	
3	$Sv-1$	Sv-1	(STEP1) Ramp/soak SV setting value	Sets the SV 0 to 100%FS	0%FS	6-1	
4	r_{T1r}	TM1r	(STEP1) Ramp time	Sets the ramp time 00:00 to 99:59 (hour : min / min : sec)	00:00 (hour : min)	16-1	
5	r_{T1S}	TM1S	(STEP1) Soak time	Set the soak time 00:00 to 99:59 (hour : min / min : sec)	00:00 (hour : min)	16-1	
						16-1	
J2	$Sv64$	Sv64	(STEP64) SV setting value	Set the SV 0 to 100%FS	0%FS	16-1	
J3	r_{T64r}	T64r	(STEP64) Ramp time	Set the ramp time 00:00 to 99:59 (hour : min / min : sec)	00:00 (hour : min)	16-1	
J4	r_{T64S}	T64S	(STEP64) Soak time	Set the soak time 00:00 to 99:59 (hour : min / min : sec)	00:00 (hour : min)	16-1	
J5	Mod	Mod	Ramp/soak mode	Set the program operation method 0 to 15	0	15-8	
J6	$GSok$	GSok	Guaranty soak ON/OFF	Sets the guaranty soak ON/OFF oFF : Guaranty soak OFF on : Guaranty soak ON	oFF (0)	15-9	
J7	$GS-h$	GS-h	Guaranty soak band (upper)	Sets the upper limit for the guaranty soak band. 0 to 50%FS	1.25%FS	15-9	
J8	$GS-L$	GS-L	Guaranty soak band (lower)	Sets the lower limit for the guaranty soak band 0 to 50%FS	1.25%FS	15-9	
J9	$PvST$	PvST	PV start	Sets whether or not to start ramp soak with PV oFF : P V start OFF on : P V start ON	oFF (0)	15-10	
K0	$ConT$	ConT	Continue mode	Sets how to restart when the controller is restored after a power loss during ramp soak. rES : Reset (hold) Con : Continue ini : Restart	rES (0)	15-11	
K1	Pf_{nM}	PTnM	Set the Max. pattern	Sets the selectable Max. number to select the pattern with the function key 0 to 30, di	30	15-12	
K2	Pf_{nM}	Pmin	Set the Min. pattern	Sets the selectable Min. number to select the pattern with the function key 0 to 30, di	0	15-12	

ChX rCP (Recipe)							
No.	Parameter			Content Explanation	Factory default	Parameter mask	Notes
	Display	Symbol	Name				
1	rCP0	rCP0	Recipe allocation 1	Sets parameter to be allocated as recipe 1 (Setting range 0-00 to W-Z9)	0-00	46-1	See 5-26.
}							
10	rCP9	rCP9	Recipe allocation 10	Sets parameter to be allocated as recipe 10 (Setting range: 0-00 to W-Z9)	0-00	46-10	
11	d00	d00	Recipe setting 0	Recipe parameter 1 setting for palette 0 (when palette is not used) (Setting range: According to rCP0 setting)	0	46-15	
}							
20	d09	d09	Recipe setting 9	Recipe parameter 10 setting for palette 0 (when palette is not used) (Setting range: According to rCP9 setting)	0	46-15	
21	d10	d10	Recipe setting 10	Recipe parameter 1 setting for palette 1 (Setting range: According to rCP0 setting)	0	46-1	
}							
30	d19	d19	Recipe setting 19	Recipe parameter 10 setting for palette 1 (Setting range: According to rCP9 setting)	0	46-10	
31	d20	d20	Recipe setting 20	Recipe parameter 1 setting for palette 2 (Setting range: According to rCP0 setting)	0	46-1	
}							
40	d29	d29	Recipe setting 29	Recipe parameter 10 setting for palette 2 (Setting range: According to rCP9 setting)	0	46-10	
41	d30	d30	Recipe setting 30	Recipe parameter 1 setting for palette 3 (Setting range: According to rCP0 setting)	0	46-1	
}							
50	d39	d39	Recipe setting 39	Recipe parameter 10 setting for palette 3 (Setting range: According to rCP9 setting)	0	46-10	
51	d40	d40	Recipe setting 40	Recipe parameter 1 setting for palette 4 (Setting range: According to rCP0 setting)	0	46-1	
}							
60	d49	d49	Recipe setting 49	Recipe parameter 10 setting for palette 4 (Setting range: According to rCP9 setting)	0	46-10	
61	d50	d50	Recipe setting 50	Recipe parameter 1 setting for palette 5 (Setting range: According to rCP0 setting)	0	46-1	
}							
70	d59	d59	Recipe setting 59	Recipe parameter 10 setting for palette 5 (Setting range: According to rCP9 setting)	0	46-10	
71	d60	d60	Recipe setting 60	Recipe parameter 1 setting for palette 6 (Setting range: According to rCP0 setting)	0	46-1	
}							
80	d69	d69	Recipe setting 69	Recipe parameter 10 setting for palette 6 (Setting range: According to rCP9 setting)	0	46-10	
81	d70	d70	Recipe setting 70	Recipe parameter 1 setting for palette 7 (Setting range: According to rCP0 setting)	0	46-1	
}							
90	d79	d79	Recipe setting 79	Recipe parameter 10 setting for palette 7 (Setting range: According to rCP9 setting)	0	46-10	

9 INDEX

	2				
2 degrees of freedom PID.....					117
	A				
Alarm delay time					54
Alarm hysteresis					54
Alarm option					52
Alarm setting					56
Alarm type					50
Alarm upper/lower limit setting.....					56
AT					48
Auto operation					72
Auto tuning function.....					48
Auto tuning method.....					48
	B				
Burnout direction.....					91
	C				
communication-Di.....					135
Control action type					44
Control templates					21
	D				
Decimal point position of the input.....					32
Derivative time					86
Digital characters					12
Digital input (Di) function.....					93
Digital output (Do) function					97
Direction at the input error burnout					91
	E				
EX-MV function					116
	F				
Function key					101
	H				
Hysteresis					87
	I				
Input decimal point position					32
Input filter time constant.....					82
Input scale.....					30
Input type.....					34
Integral time					86
Integration upper/lower cut point.....					88
	K				
Key lock function					90
			L		
			LED allocation setting		99
			Limit value of MV		84
			Limit value of MV change rate		84
			Limit value of transfer output		63
			Linearize.....		133
			Local SV.....		78
			M		
			Manual operation.....		74
			Manual operation prohibition setting		111
			Math function.....		106
			Monitor		81
			MV polarity.....		137
			O		
			Operation display setting		118
			Operation during standby.....		79
			Operation mode		69
			Output convergence value		88
			Output during standby		80
			Output limiter type setting.....		84
			Output type		38
			P		
			Palette switching method setting.....		89
			Parameter jump		101, 104
			Parameter mask.....		115
			Password.....		114
			PID, PID operation cycle.....		86
			Proportion cycle.....		42
			Proportional band		86
			R		
			Ramp/Soak.....		138
			Recipe.....		130
			Remote acknowledge (R-ACK) function		110
			Remote operation		76
			Remote operation prohibition setting.....		109
			Remote SV		76
			Reset command		40
			Resetting alarm latch.....		52
			Re-transmission		60
			RS485.....		65
			S		
			Scale of input.....		30
			Scale of transfer output		60
			Screen display selection function		118
			Set value (SV).....		46
			Setting (SV)		46
			Setting communications		65
			Setting operation mode at the time of power ON		112
			Standby function		79
			SV limit value.....		47
			SV tracking.....		113

SV upper/lower limit value47

T

Terminal connection diagram152

Totalizer95, 96, 119

U

Unit of input..... 36

Upper/lower limit value of MV..... 84

User adjustment 92

Z

Zero/span adjustment value of input 92

Fuji Electric Co., Ltd.

International Sales Div

Sales Group

Gate City Ohsaki, East Tower, 11-2, Osaki 1-chome,
Shinagawa-ku, Tokyo 141-0032, Japan

<http://www.fujielectric.com>

Phone: 81-3-5435-7280, 7281 Fax: 81-3-5435-7425

<http://www.fujielectric.com/products/instruments/>
