



Instruction Manual

**ULTRASONIC FLOWMETER
FOR AIR**

TYPE: FWD

TABLE OF CONTENTS

Preface.....	2
Product Overview	2
Safety Instructions	3
1. Introduction	6
1-1. Scope of supply	6
1-2. Name of each part.....	6
2. Installation	7
3. Setting Up	12
3-1. Measurement and indication setting.....	13
3-2. Output setting (for external power supply type)	14
4. Display	16
4-1. Button operations	16
4-2. Operation modes	18
4-3. Setting items	21
5. Wiring (External Power Supply Type).....	27
6. Operation	29
7. Alarm.....	30
7-1. Aberration in flow measurement	30
7-2. Aberrant pressure value.....	31
7-3. Aberrant temperature value	31
7-4. Memory aberration.....	32
8. Power Interruption (External Power Supply Type)	33
9. Battery Life (Built-In Battery Type)	34
10. Troubleshooting	35
11. Outline Diagram	37
Warranty and Maintenance	38

Preface

Thank you very much for purchasing the Ultrasonic Flow Meter for Air FWD this time. Please be sure to read this Instruction Manual to use this product correctly and safely and to prevent failures. Please arrange for operators who actually use this product to know the context of this Instruction Manual surely. This Instruction Manual is necessary for performing maintenance, too. Please keep the Manual until this product is disposed of.

Product Overview









This flow meter is the ultrasonic flow meter for air capable of measuring the flow of air at pressure from the atmospheric pressure to less than 1 MPa. The flow meter is installed to pipes by screwing its taper pipe threads to the pipes or by being tightened between pipe flanges.

- Screw connection type (Taper pipe threads): FWD025, FWD032
- Wafer connection type (Installation between pipe flanges and by tightening with bolts):
FWD040, FWD050, FWD065, FWD080
- Flange connection type (JIS 10K flange): FWD100, FWD150, FWD200





Safety Instructions

To ensure the safe use of this flow meter and to prevent a failure or an unexpected situation, instructions to which attention must be paid are indicated with the following symbols.







Definitions

 Danger	Incorrect handling by failure to follow instructions with this sign may lead to imminent danger of death or serious injury.
 Warning	Incorrect handling by failure to follow instructions with this sign may lead to death or serious injury.
 Note	Incorrect handling by failure to follow instructions with this sign may lead to injury, properties loss (product damage, etc.), pecuniary loss, and/or punishment according to a penal regulation for violation of laws and ordinances.
	 This symbol indicates that improper operation may result in an accident.
	 This symbol indicates prohibited acts.
	 This symbol indicates matters you should observe without fail.



General

 Danger	<ul style="list-style-type: none">  Do not use for applications that require safety, such as nuclear, railroad, aircraft, vehicle, playground equipment, etc.  Do not modify the product.  Do not use the product for foods, drinks, medical chemicals, etc., because it is not of sanitary specifications.  Do not use the product in the atmosphere of an inflammable gas, etc., because it is not of explosion-proof specifications.
---	---





Working environment and applicable fluid

 Note	<ul style="list-style-type: none">  Do not apply any fluid other than air (compressed air used in factories) to this flow meter. (The meter can be applied for nitrogen by factory setting before shipment from our factory.)  Observe the temperature and humidity ranges (-10 to +60°C and 90%RH or lower) and pressure range (the atmospheric pressure to less than 1 MPa) in use.  Avoid usage in an ambient containing a corrosive gas (chlorine, hydrogen sulfide, etc.) and/or for an application to a fluid containing a corrosive gas.  This flow meter is not of a perfect waterproof structure (IP64). Do not install it at a place that may be submerged in water.  Install the flow meter as far away from an electric noise source as possible. If it is installed near the electric noise source, ground the shield of the external connection cable. • The installation of a sunshade is recommended if the flow meter is exposed to direct sunlight.
--	--





Operation

 Note	<ul style="list-style-type: none">• This flow meter is not a specified measuring instrument defined in Japanese measurement law. The product cannot be used for billing transactions or certification.•  When opening a valve to start fluid flow, open the valve not all at once but gradually. Opening of the valve all at once may cause a failure of the flow meter if a pressure difference is occurring between the upstream side and downstream side of the valve.
--	---



Storage

 Note	<ul style="list-style-type: none">•  Store the flow meter at a place away from fire and not exposed to direct sunlight.•  Do not place any combustible material, inflammable substance and heating body in the periphery of the flow meter.•  Store this flow meter at a place which ambient temperature is -20 to +70°C and where no dew condensation occurs.
--	---

Piping

 Warning	<ul style="list-style-type: none">•  Do not ride on this flow meter using it as a foothold.•  Do not hold the display section of this flow meter.
 Note	<ul style="list-style-type: none">• In the case that a flow-regulating valve, etc., that may cause turbulence of the flow is installed, its location must be on the downstream side of the flow meter.• In the case of new piping, install the product after sufficient cleaning of the pipe(s).• Vertical piping is recommended when mist, dust, etc. are contained in a large amount. In horizontal piping, install the flow meter in such a way that the display section faces upward.• Do not install the product in locations where strong compressive force, tensile force, or load may be applied after its installation.• Arrange piping so that the flow direction conforms to the direction of arrow indicated on the flow meter's body.• Do not drop it or do not make it bumped. Do not apply excessive impact, either.• When rotating the display section, do not apply a force in a direction other than the rotating direction.•  Keep hands off the ultrasonic sensors.

Wiring

 Danger	<ul style="list-style-type: none">ⓘ When performing wiring work, follow the instructions in this Manual.ⓘ Use the product within the rating.⊘ Do not use the product on a voltage exceeding permissible load.
 Note	<ul style="list-style-type: none">• Do not place the product's external connection cable together with or near to power supply line(s) or power line(s), etc.• Electrical isolation of a remote counter (a receiver) from others is recommended.• Do not apply an excessive tensile force to the external connection cable.• Ensure that the cable tip is not soaked in water during wiring work, etc.ⓘ When connecting the power supply wire of the external connection cable to an external power supply, be careful not to short-circuit it. Use an external power supply having a short-circuit protecting function.ⓘ Be sure to perform the wiring work in a state that power supply from the external power supply is interrupted.⊘ Do not perform operation and the wiring work with wet hands.

Disassembling and inspection

 Note	<ul style="list-style-type: none">⊘ Do not disassemble this flow meter.• Presence of fluid flow makes a pilot lamp light up in a normal state. In the case of no indication of the pilot lamp, contact our branch or sales office nearby.• If mist and dust is contained in a large amount, disconnect the flow meter periodically to check for the presence of dirt etc., and remove it as necessary.ⓘ Be careful not to touch the ultrasonic sensors during inspection.
--	--

Disposal

 Warning	<ul style="list-style-type: none">ⓘ A lithium ion battery is incorporated in this flow meter. NEVER dispose of this flow meter through general disposal routes. [Built-in battery type]ⓘ NEVER throw this flow meter into a fire. Otherwise, it may catch a fire or explode. [Built-in battery type]
---	---

1. Introduction

1-1. Scope of supply

Upon delivery of the product, confirm that the following items are contained in the package:

Name	Q'ty	Remarks
Ultrasonic flowmeter	1	
Centering collars	4	See about usage. Accessory of the wafer connection type
M4 hexagonal wrench	1	
Flange gasket	2	Accessory of the wafer connection type
Instruction Manual (This document)	1	
Bolt set (Bolts/nuts/plain washes)	1 set	The bolts/nuts/plain washes are put into a bag in a set of required quantities Accessory of the wafer connection type
External connection cable (external power supply type)	1	5 m or 20 m (Option)

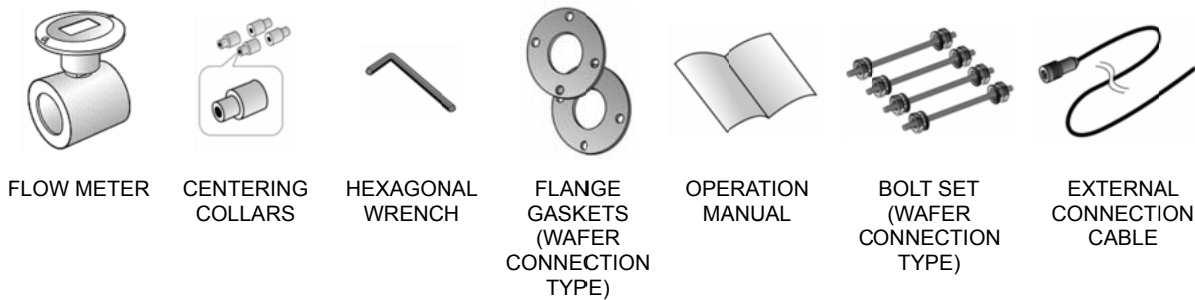

1-2. Name of each part

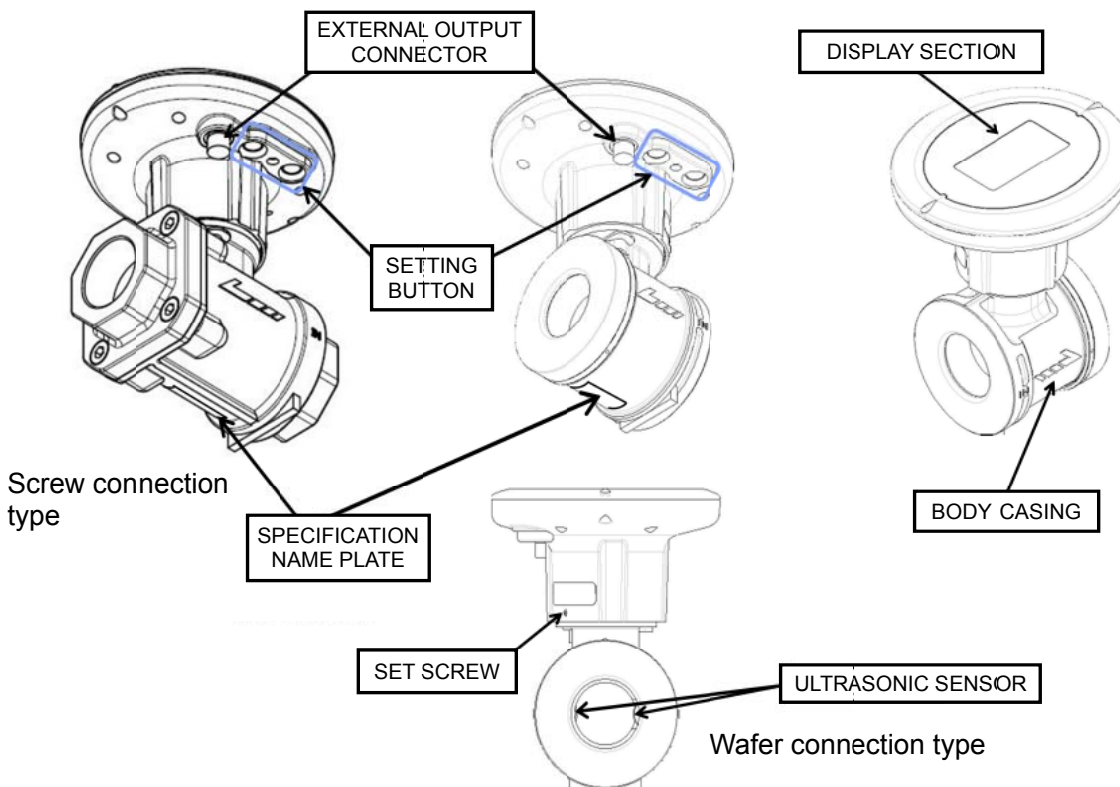

2. Installation

It is recommended that Setting Up (Page 12 onward) and changing Panel angle adjustment: (Page 11) are carried out before installation.

- This flowmeter can be installed both indoors and outdoors and on a horizontal pipe and a vertical pipe.
- When a large amount of mist and/or dust exists inside pipe, the vertical piping is recommended. When installing the flow meter horizontally, install it in such a way that the display section faces upward.
- This flow meter is not of a perfect waterproof structure (IP64). Do not install it at a place where may be submerged in water.
- The use of a sunshade is recommended if the flow meter is exposed to direct sunlight.
- If you install the flowmeter in the place where it may get wet with rain, install the flowmeter so that the display section does not face downward.
- When you carry out the piping work, keep hands off inside the body and the ultrasonic sensors (see Page 6) in particular.
- ⊘ Do not hold the display section of the flow meter.

Flow direction:

- Mate the forward flow direction of a fluid to the arrow of the body.

Straight run requirements:

Figure 2-1 Recommended straight pipe run

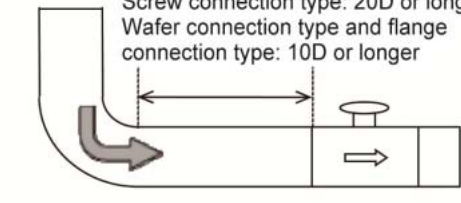
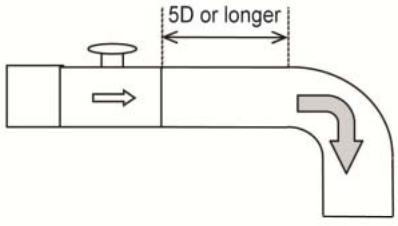
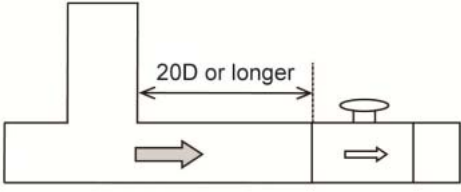
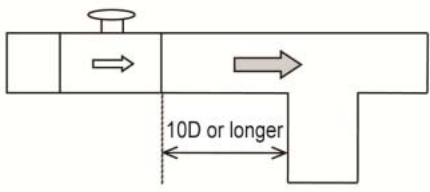
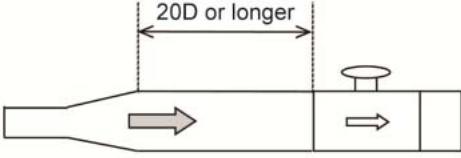
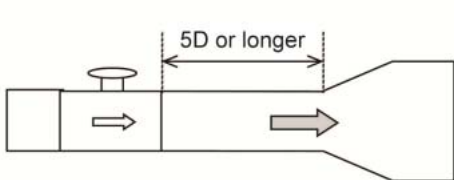
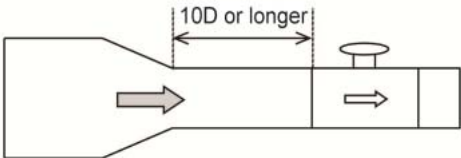
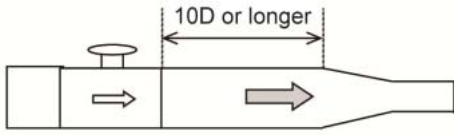
Condition	Upstream side	Downstream side
90° elbow / full open of full-bore valve	<p>Screw connection type: 20D or longer Wafer connection type and flange connection type: 10D or longer</p> 	
Confluence		
Enlarged pipe		
Reduced pipe		

(D: nominal diameter)

When the flow meter is installed near a pressure-reducing valve or a flow adjustment valve, strictly observe the “required straight run L” as shown in Figure 2-2, because ultrasonic noise may be generated inside the pipe.

Note that when the flow meter is installed at the downstream of the pressure-reducing valve etc., there are many constraints. (If conditions are not satisfied, there is a possibility that flow cannot be measured.)

$$\text{Required straight run L (mm)} = 10D + \text{differential pressure (kPa)} \times D \times \frac{\text{Maximum working flow velocity (m/s)}}{20 \text{ (m/s)}} \times (0.8)^{\text{Number of elbows}}$$

Figure 2-2 Required straight pipe run for installation near valve

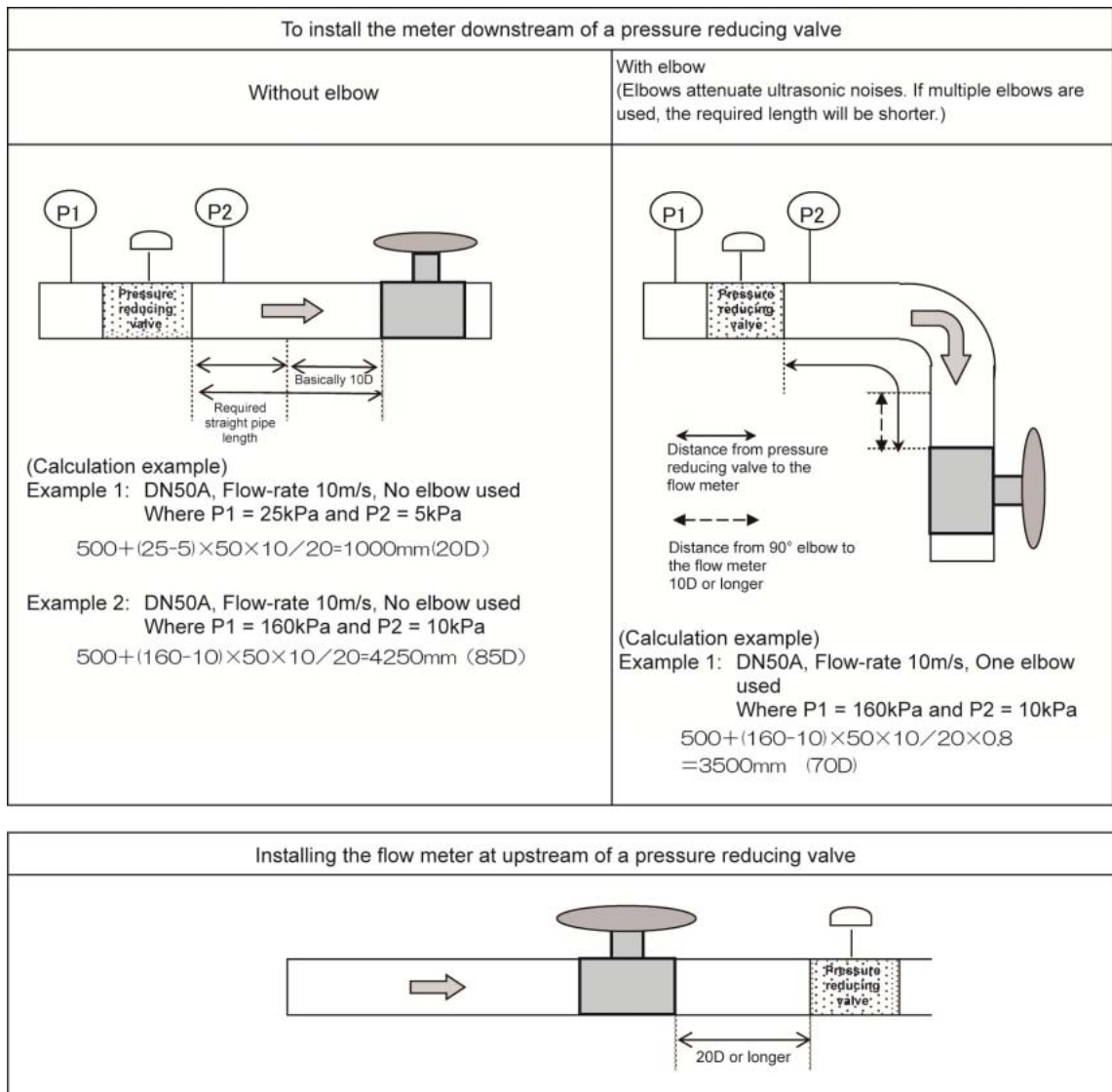

Wafer connection type:

Install the flowmeter so that the central axis of the flow meter is aligned to that of pipes to be connected. To reduce the displacement of the central axes of the flow meter and the pipes, it is recommended that the centering collars provided as accessory be used. As shown in Figure 2-3, insert the centering collars provided as accessory into the holes of flange gaskets and flanges. By fitting the flow meter to the centering collars, the central axis of the flow meter can be aligned to that of the pipe. If it is difficult to install the centering collars at both upstream and downstream sides due to the misalignment etc. of pipes, install the collars only at the upstream side.

Figure 2-3 Attaching centering collars

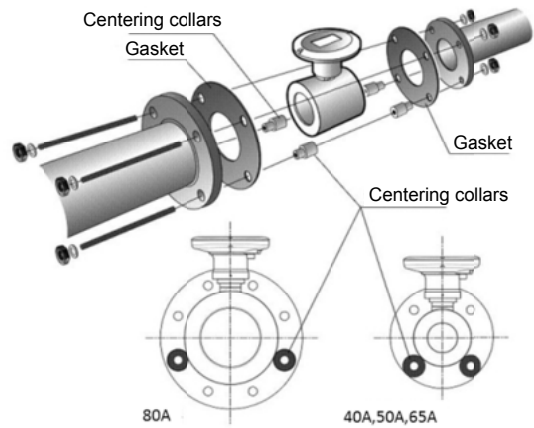

Flange type:

Install the flange type flow meter so that the central axis of the flow meter is aligned to that of a pipe. To reduce the displacement of the central axes of the flow meter and the pipe, it is recommended that the centering collars provided as accessory be used. As shown in Figure 2-4, insert the centering collars provided as accessory into the holes of flange packings and flanges when installing the upstream side.

Figure 2-4 Attaching centering collars

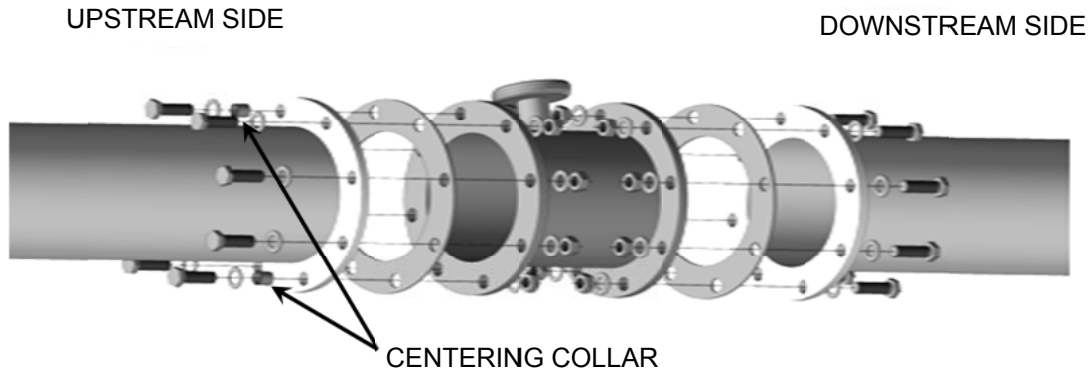

- For the wafer connection type and flange connection type, take care so that the flange gaskets will not extend inside a pipe.

Screw connection type:

Fix the flowmeter by screwing its taper pipe threads to pipes within the following torque range.

FWD025: 36 to 38 Nm
FWD032: 47 to 49 Nm

Panel angle adjustment:

The display can be rotated. It is recommended to change the direction before installation. To change the direction of the display section, temporarily loosen a set screw on the neck part of the display section with the M4 hexagonal wrench provided as accessory, and then rotate the display section. Do not fail to fix the display section by tightening the set screw at a desired position.

The display section can be rotated by 90° clockwise and 180° counterclockwise from the setup at the factory.

When rotating the display section, do not apply force in a direction other than the rotating direction.

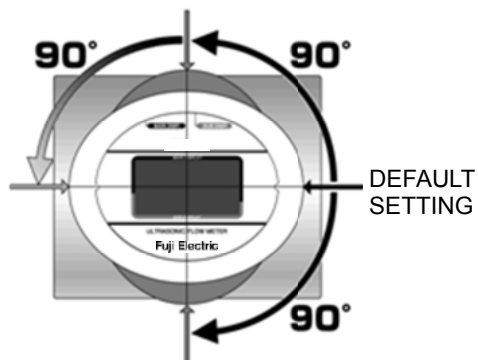

3. Setting Up

It is recommended that the setting of the flow meter be carried out before installation.

For this flow meter, 20 items shown in Table 3-1 can be set. On delivery from factory, the “factory default settings” in Table 3-1 are arranged, so that the flow meter can be used as it is. Change the setting as necessary to make them suit to your working conditions.

See “4. Display” about button operations and setting methods.

Table 3-1 Setting items and standard factory settings

	Setting item	Setting options	Factory settings
F1	Indication and output	Forward flow, forward and reverse flow	Forward flow
F2	Analog output full scale flow-rate	0 to 99999 [m ³ /h]	25A:300 32A:600 40A:700 50A:1200 65A:2000 80A:2500 100A: 5000 150A: 10000 200A: 20000
F3	State of contact output	Normal open, Normal close	Normal open
F4	Contact output	Reverse flow pulse, upper/lower limit flow-rate alarm, error alarm, electronic statement output	Upper/lower limit flow-rate alarm
F5	Lower limit alarm flow-rate	-59999 to 59999 [m ³ /h]	0 [m ³ /h]
F6	Upper limit alarm flow-rate	-59999 to 59999 [m ³ /h]	59999 [m ³ /h]
F7	Alarm judgment value hysteresis width	0 to 9999 [m ³ /h]	0 [m ³ /h]
F8	Flow-rate moving average number of times	01, 02, 04, 08, 16, 32, 64 [times]	04 [times]
F9	Output pulse unit		100 [L] 1000 [L] for 100A and larger
F10	Pulse output method	Duty or one shot 50, 100, 125, 250, 500 [ms]	Duty
F11	Flow-value conversion selection	Yes (Normal), Yes (Standard), No conversion	Yes (Normal)
F12	Standard conversion temperature	-10 to 60 [°C]	20 [°C]
F13	Test mode time selection	3, 60, Unlimited [minutes]	3
F14	Fluid selection	Air (25A–200A) Nitrogen (25A–80A)	The kind of gas is set as the kind specified at the time of order.
F15	Current output correlation value	Instantaneous flow-rate, pressure, temperature	Instantaneous flow-rate
F16	Low flow cutoff flow-rate	$0 \leq \text{Set value} \leq Q_{\min}^{*2}$ [m ³ /h]	25A:0.1 32A:0.2 40A:0.2 50A:0.4 65A:0.6 80A:0.8 100A: 2.6 150A: 5.0 200A: 9.0
F17	Atmospheric pressure of the working environment	000.0 to 999.9 [kPa]	101.3
F18	With or without pressure value averaging	With (10 times), without (1 time)	With (10 times)
F00	Reset of all of accumulated values	To be cleared, not to be cleared	Not to be cleared
FFF ^{*1}	Reset to standard factory delivery settings	To be reset, not to be reset	Not to be reset

Notes:

1. After resetting, "F9: Output pulse unit" will be set to 1000 [L], and "F14: Fluid selection" will be set to Air.
2. Qmin is the following value depending on the nominal diameter.

[m ³ /h]								
25A	32A	40A	50A	65A	80A	100A	150A	200A
0.6	1.1	1.3	2.5	4.0	5.0	10.0	24.0	40.0

Setting items include the one related to fluid to be applied, the ones related to measurement and indication, and the ones related to outputs.

3-1. Measurement and indication setting

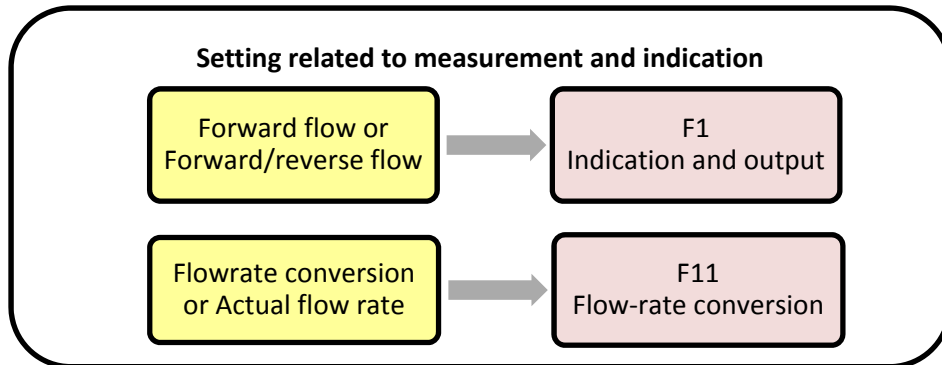

Indication of “Forward flow” or “Forward/reverse flow” [F1]

Indication of a main display is set.

When the “Forward flow” is selected, forward accumulated flow volume (total) or accumulated flow volume (trip) can selectively be indicated on the main display by button operation.

When the “Forward/reverse flow” is selected, forward accumulated flow volume (total) or reverse accumulated flow volume (total) can selectively be indicated on the main display by button operation. When the analog output (4-20 mA) is selected for the flow-rate output, the electric current value of the zero flow-rate output becomes 12 mA.

Flow-rate conversion

Select one among “actual flow-rate (OFF)”, “normal conversion flow-rate (Normal)”, or “standard conversion flow-rate (Standard)”. If you select “normal conversion flow-rate (Normal)” or “standard conversion flow-rate (Standard)”, both indication and output of accumulated flow rate and instantaneous flow rate are converted into the values under normal conditions or standard conditions.

3-2. Output setting (for external power supply type)

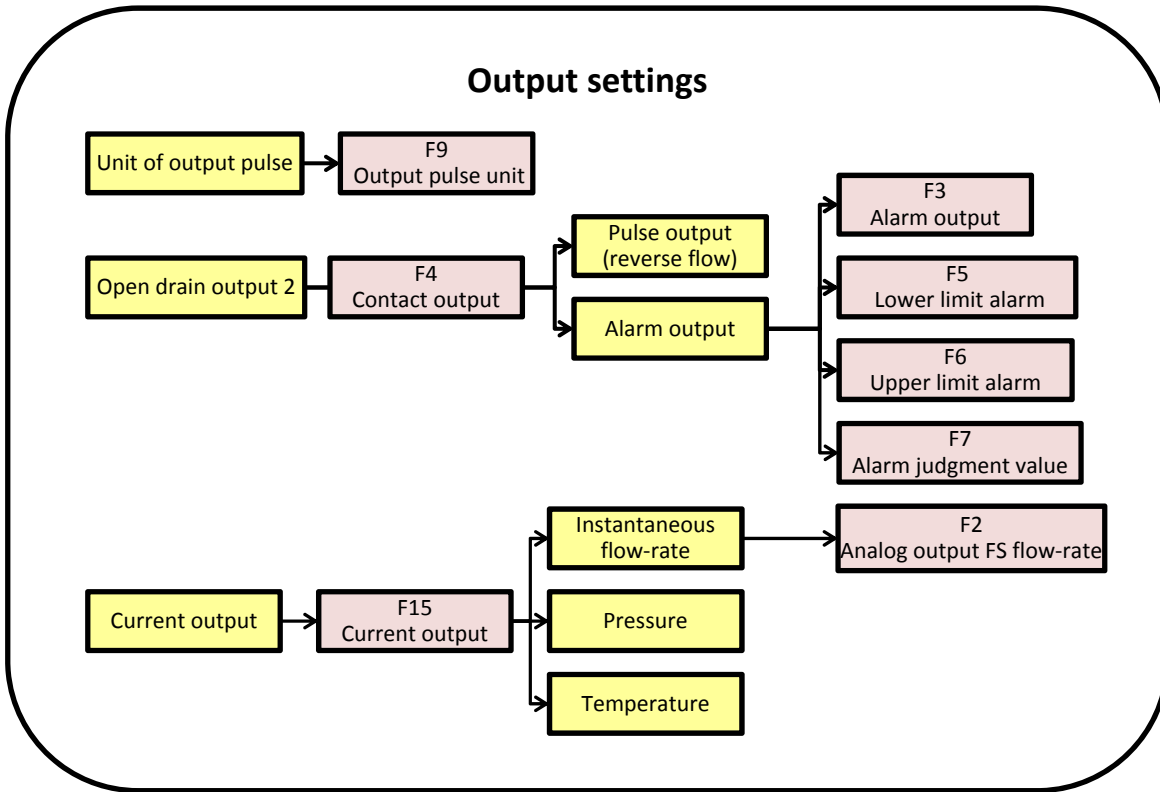

It is recommended that the setting of the flow meter be carried out before installation.

Current output [F15]

One of three output forms of instantaneous flow-rate, pressure and temperature can be selected for the current output to suit your usage. When the instantaneous flow-rate is selected, electric current corresponding to the setting of the maximum flow-rate value of the analog output is outputted. When the pressure is selected, 4 mA is outputted at the atmospheric pressure, and 20 mA is outputted at 1 MPa. When the temperature is selected, 4 mA is outputted at -10°C, and 20 mA is outputted at +60°C.

Maximum flow-rate value of the analog current output (Analog output FS flow-rate) [F2]

When the analog output is used by setting to the instantaneous flow-rate, it is recommended that full scale flow-rate (FS flow-rate) of the analog current output be set with a value corresponding to maximum flow-rate used. It is recommended that a numerical value having a margin be set as a set value of the FS flow-rate. (Setting example of the FS flow-rate: A set value at the time of nominal diameter 50mm, flow-rate conversion "With(ON)", room temperature (30°C), pressure 0.7 MPa, flow speed 10m/s: 600 m³/h)

As a reference, Table 3-2 shows examples of conversion.

Table 3-2 Flow rate conversion examples

	Pressure (MPa)	0 (Atmospheric pressure)		0.5		0.7		0.98	
	Temperature (°C)	0	30	0	30	0	30	0	30
FWD025	0.6(m ³ /h)	0.6	0.5	3.6	3.2	4.7	4.3	6.4	5.8
	35(m ³ /h)	35	32	210	190	280	250	370	330
FWD032	1.1(m ³ /h)	1.1	1.0	6.5	5.9	8.7	7.8	12	11
	65(m ³ /h)	65	59	390	350	510	460	690	630
FWD040	1.3(m ³ /h)	1.3	1.2	7.7	7.0	10	9.3	14	13
	80(m ³ /h)	80	72	470	430	630	570	850	770
FWD050	2.5(m ³ /h)	2.5	2.3	15	13	20	18	27	24
	150(m ³ /h)	150	135	890	800	1180	1070	1600	1440
FWD065	4(m ³ /h)	4.0	3.6	24	21	32	29	43	39
	240(m ³ /h)	240	220	1420	1280	1900	1710	2560	2310
FWD080	5(m ³ /h)	5.0	4.5	30	27	40	36	53	48
	300(m ³ /h)	300	270	1780	1600	2370	2140	3200	2880
FWD100	10(m ³ /h)	10	9	59	53	79	71	110	96
	500(m ³ /h)	500	450	2970	2670	3950	3560	5340	4810
FWD150	24(m ³ /h)	24	22	140	130	190	170	260	230
	1200(m ³ /h)	1200	1080	7120	6420	9490	8550	12810	11540
FWD200	40(m ³ /h)	40	36	240	210	320	290	430	390
	2000(m ³ /h)	2000	1800	11870	10700	15820	14250	21340	19230

Output pulse unit [F9]

When a pulse output of the open drain output 1 (forward pulse output) is used, set the output pulse unit in advance so as to suit your working conditions. The output pulse unit set here is reflected in the open drain output 2 (reverse flow pulse output), too.

Contact output [F4]

You can select from the pulse output (reverse flow), the flow-rate upper/lower limit alarm output, and the main unit aberration output. When the pulse output (reverse flow) is selected, set the output pulse unit. However, when the output pulse unit is set in advance for the use of the open drain output 1 (forward flow pulse output), it is not necessary to set it here.

For the upper/lower limit alarm output, an alarm can be outputted or stopped with a desired flow-rate value.

When this function is selected, set the alarm output contact state (F3), the lower limit alarm flow-rate (F5) and the upper limit alarm flow-rate (F6), and the alarm judgment value hysteresis width (F7).

4. Display

Figure 4-1 Display and buttons

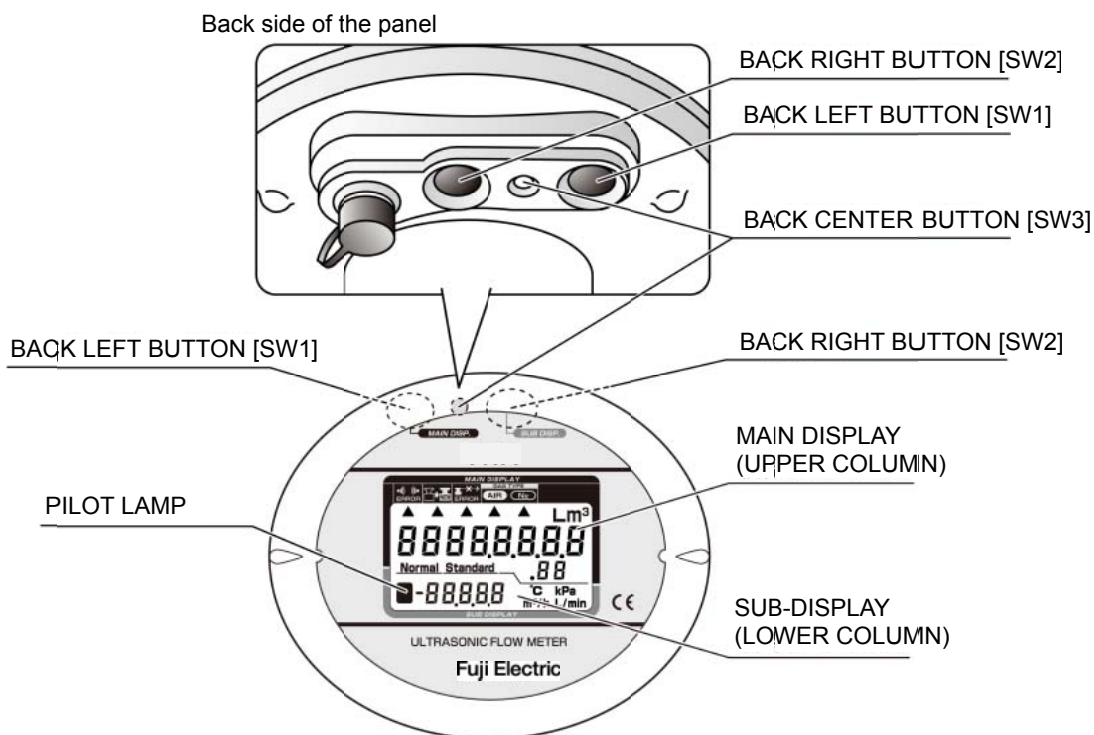

4-1. Button operations

- Usually is the measurement mode, and the main display (upper column) shows accumulated flow volume, and the sub-display (lower column) shows instantaneous flow-rate.
- Various individual setting items can be set at a local site by the three button switches provided on the back of the display section.
- See Figure 4-1 about the arrangement of “SW1”, “SW2” and “SW3.”
- By performing button operations in Table 4-1, the flow meter can be shifted to various modes as shown in Figure 4-2.

Table 4-1 How to operate buttons in measurement mode, setting mode, and test mode

Button position and name		Measurement mode	Setting mode		Test mode
Button position	Name		Local setting indication	Setting of details	
Back left	SW1	Changeover of Forward accumulated flow volume (total) / accumulated flow volume (trip) / instantaneous flow-late (L/min)	Changeover to the next setting item	Changeover of setting details, Movement of blinking digit.	/
		Changeover of Forward accumulated flow volume (total) / reverse accumulated flow volume (total) / instantaneous flow- late (L/min)			
Back right	SW2	Changeover of Instantaneous flow-late (m ³ /h) / Pressure / temperature ²⁾	Changeover to the previous setting item	Change of a numerical value at a blinking portion	Switchover to measurement mode
	SW2 for three seconds	Changeover to test mode			
Back center	SW3	Changeover to setting mode	Changeover to measurement mode		/
/	SW1+SW2 ¹⁾	Resetting of trip accumulation to zero ³⁾	Changeover of local setting indication and setting of details		/

Notes:

1. "SW1+SW2" indicates that two switches are pressed simultaneously.
2. Indication cannot be changeover when the main display shows the instantaneous flow-rate [L/min].
3. Accumulated flow volume (trip) is reset to zero in the following cases:
 - When SW1+SW2 are pressed during the indication of accumulated flow volume (trip)
 - If power supply is interrupted by a power failure [External power supply type]

Figure 4-2 Transitions between each operation mode

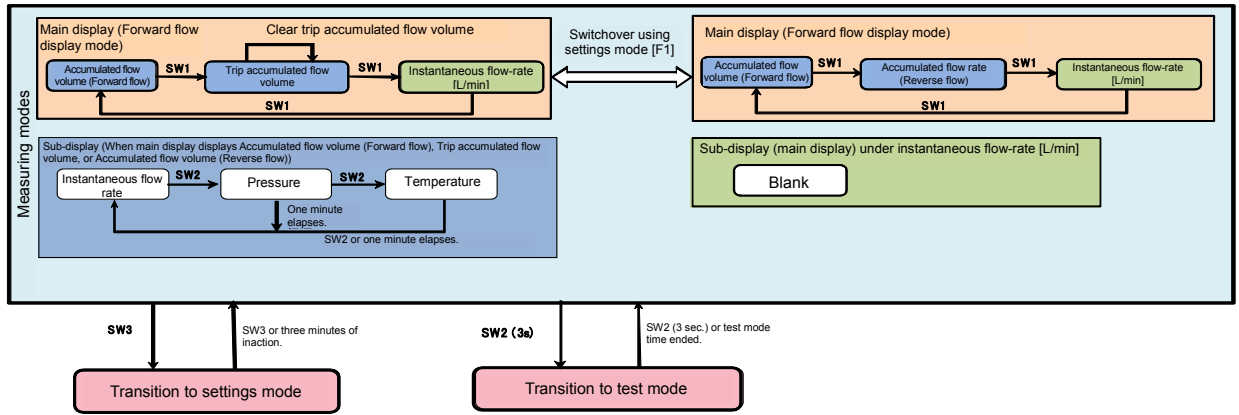

4-2. Operation modes

Measurement mode

This mode is for measuring flow-rate, pressure, and temperature. The meter will remain in this mode unless you operate any of its buttons.

The main display (upper column) displays the accumulated flow volume, and the sub-display (lower column) shows the instantaneous flow-rate.

Figure 4-3 Example of measurement mode

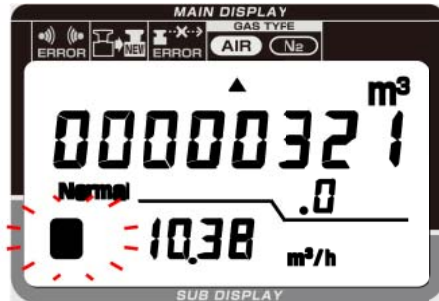

Switchover of the main display

When the forward flow is selected in [F1: Indication/output]

- Each time SW1 is pressed, the display will cycle from trip accumulated flow volume to instantaneous flow-rate [L/min] and then to accumulated flow volume (forward flow).

Figure 4-4 Main display (forward flow)

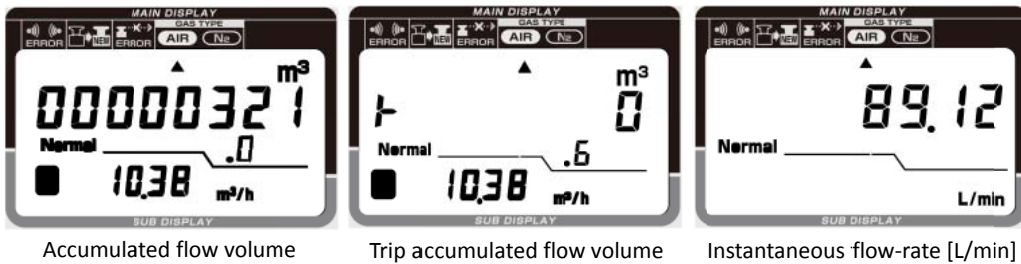

- By pressing SW1 and SW2 simultaneously while trip accumulated flow volume is displayed, trip accumulated flow volume can be canceled.
- If the trip accumulated flow volume overflows beyond 9999999.9, the display will show 0000000.0 without zero suppression and continue its accumulation operations.

Figure 4-5 Trip accumulated flow volume

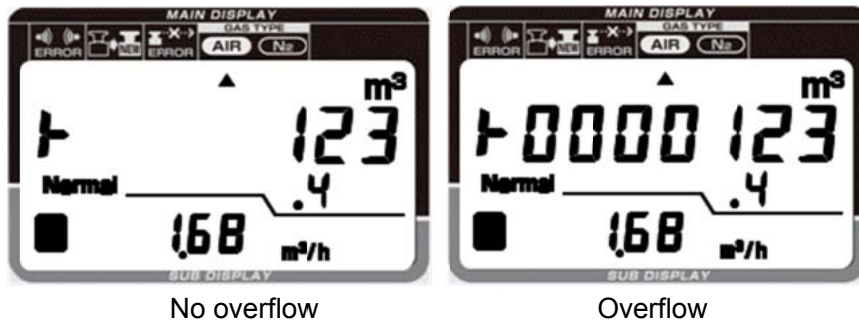

When forward/reverse flow is selected in [F1: Indication/output]:

- Each time SW1 is pressed, the display will cycle from accumulated flow volume (Reverse flow) to instantaneous flow-rate [L/min] and then to accumulated flow volume (forward flow).

Figure 4-6 Main display (forward/reverse flow)

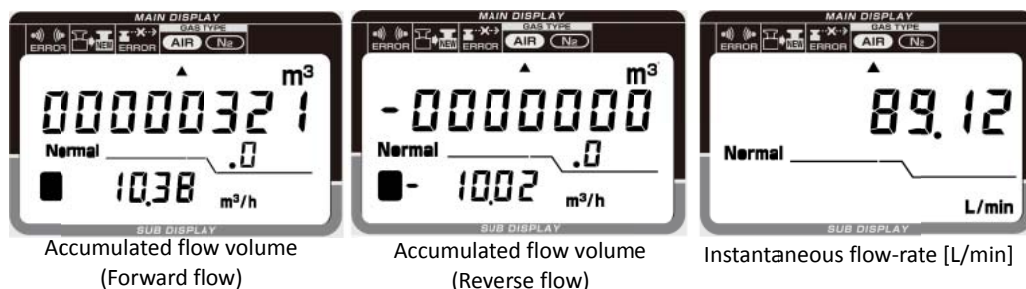

Sub-display (lower column)

In the case of [Main display: Forward accumulated flow volume (total), accumulated flow volume (trip), and reverse accumulated flow volume (total)]

Each time “SW2” is pressed,” the indication changes in order of pressure, temperature, maintenance^{*1}) and instantaneous flow-rate.

When one minute elapses during the indication of pressure, temperature or maintenance, the indication is shifted to the instantaneous flow-rate automatically.

Test mode

The test mode is a function that releases low flow cutoff temporarily.

- Perform the test mode in a state of no flow. When “SW2” is pressed for 3 seconds or more during the measurement mode, the mode is shifted to the test mode so that a very small flow-rate can be measured.
- During the test mode, a unit of the sub-display (“m³/h”, “kPa”, “°C”, “L/min”) blinks at the intervals of 0.5 seconds.
- Test mode times of three kinds of 3 minutes, 60 minutes, and no limit can be selected in the setting mode. When the set time elapses, the test mode is automatically shifted to the measurement mode [F13]. When the “SW2” is pressed for 3 seconds or more once again during the test mode, it is shifted to the measurement mode.
- When an indicated value of the instantaneous flow-rate is a flow-rate value of (+)0.1 or more, there is a possibility of leakage* at the downstream side.
- When an indicated value of the instantaneous flow-rate is a flow-rate value of -0.1 or less, there is a possibility of leakage* at the upstream side.

*Possibility of leakage: As an indicated value includes offset of zero flow-rate, inside convection, etc., it indicates only a possibility.

- An instantaneous flow-rate during the test mode is indicated by rounding at 3rd decimal place.

Example) Indication: 0 to 0.004 [m³/h] → 0.00 [m³/h]

Indication: -0.004 to 0 [m³/h] → -0.00 [m³/h]

Setting mode

- Press “SW3” to shift the flow meter to the setting mode. To shift from the setting mode to the measurement mode, press the “SW3” again. When no operation is made for 3 minutes in the setting mode, it is shifted to the measurement mode automatically. Press the “SW3” with the M4 hexagonal wrench provided as accessory, etc. Note: “SW3” may be broken if pressed by a sharp pointed tool.
- In the setting mode, setting details shown in the “Table 3-1 Setting items and standard factory settings” (Page 12) can be changed.
- See figures of changeover of indication of various setting modes in Figure 4-2 for button operation methods in the setting mode.

4-3. Setting items

[F1] Indication/output

In the indication/output, “forward flow (d.F.)” measurement or “forward/reverse flow (d.r.F)” measurement is selected.

When the “forward flow” measurement is selected, the “forward accumulated flow volume (Total)” or the “accumulated flow volume (Trip)” can be indicated on the main display by button operation. When the instantaneous flow-rate is set with the analog output (4-20 mA), 4 mA becomes zero flow-rate.

When the “forward/reverse flow” is selected, the “forward accumulated flow volume (Total)” or “reverse accumulated flow volume (Total)” can be indicated on the main display by button operation. The trip function cannot be used. When the instantaneous flow-rate is set with the analog output (4-20 mA), 12 mA becomes the zero flow-rate.

See “4. Description of operation of display section” about the button operation.

[F2] Analog output FS (Full Scale) flow-rate

This function sets a full scale flow-rate value when the instantaneous flow-rate is set with the analog output. On delivery from factory, the flow-rate value shown in the Table 3-1 or Table 3-2 is set. When in use with the NORMAL conversion set to “With (ON)” set a NORMAL conversion value.

[F3] State of contact output

Select "Normal open (n. OP)" or "Normal close (n. CL)."

Set this to "Normal open" in case of using a battery-powered signal receiving device.

[F4] Contact output

Select the output signal of open drain output 2 from “pulse output (reverse flow) (PULS),” “main unit aberration output (Err),” “upper/lower limit flow-rate alarm output (AL),” and “electronic statement output (COdE).”

“Main unit aberration output (Err)” outputs signals when one of the following occurs: ultrasonic measurement aberration, pressure measurement aberration, temperature measurement aberration, battery voltage reduction (for the built-in battery version only), and elapse of 11 years.

[F5] Lower limit alarm flow-rate

Use this to set the lower limit alarm flow-rate (5 digits) as the lower limit flow-rate value for the upper/lower limit flow-rate alarm.

* This is the judgment value for flow-rate lower limit alarm output of open drain output 2.

[F6] Upper limit alarm flow-rate

Use this to set the upper limit alarm flow-rate (5 digits) as the upper limit flow-rate value for the upper/lower limit flow-rate alarm.

* This is the judgment value for flow-rate upper limit alarm output of open drain output 2.

[F7] Alarm judgment value hysteresis width

With regard to the flow-rate value defined for the upper/lower limits of the upper/lower limit flow-rate alarms, a hysteresis width range (4 digits) is defined for the alarm judgment value as the range of flow-rates for terminating the alarm.

*This is the judgment value for flow-rate upper/lower limit alarm output of open drain output 2.

[F10] Pulse output method

Select from one of the five one-shot modes (ON time “50ms,” “100ms,” “125ms,” “250ms,” or “500ms”) or Duty mode. Selecting one of the one-shot modes is recommended in case the signal receiving instrument you are using is battery-powered. Make sure to check the specifications of the signal receiving instrument and set the appropriate ON time from Figure 4-7.

[F11] Flow-rate conversion selection

Select "actual flow-rate (OFF)", "normal conversion flow-rate (Normal)", or "standard conversion flow-rate (Standard)" for flow value conversion. If you select “normal conversion flow-rate (Normal),” the “Normal” lamp above the partition line will flash. If you select “standard conversion flow-rate (Standard),” the “Standard” lamp will flash. If you select “No conversion,” both lamps will turn off. The accumulated flow volume display, instantaneous flow-rate display, and output signal will all correspond to the selection of whether to convert the flow-rate or not.

See below for the definition of flow-rate conversion and the conversion equation.

$$Q_2 [m^3/h] = \frac{273.15}{(273.15 + t)} \times \frac{P_1 + \text{atmospheric pressure [kPa]} [F17]}{101.33} \times q_1$$

Q₂: Normal conversion flow-rate [m³/h]

t: Measured temperature [°C]

P₁: Measured pressure [kPa]

q₁: Actual flow-rate [m³/h]

$$Q_2 [m^3/h] = \frac{273.15 + T}{(273.15 + t)} \times \frac{P_1 + \text{atmospheric pressure [kPa]} [F17]}{101.33} \times q_1$$

Q₂: Standard conversion flow-rate [m³/h]

T: Standard conversion temperature [°C] [F12]

t: Measured temperature [°C]

P₁: Measured pressure [kPa]

q₁: Actual flow-rate [m³/h]

[F12] Standard conversion temperature

This is used to set the temperature [°C] to use as the basis for standard conversion. The temperature can be set within a range between -10°C and +60°C in 1°C increments. This setting is not available if an option other than standard conversion is selected in [F11].

[F13] Test mode time selection

Test mode times available for selection are "3 min. (3)," "60 min. (60)," and "Unlimited (--)." During test mode, the unit on sub display blinks.

[F14] Fluid selection

Select either "Air (Air)" or "Nitrogen (N2)." Even if you specified a flow meter for air in your initial order, you can change this setting so that it can be used for nitrogen.

[F15] Current output correlation value

Select "Instantaneous flow-rate (FLo)", "Pressure (PrS)", or "Temperature (tEP)" for the functional assignment of the current output. When instantaneous flow-rate is selected, the instantaneous flow-rate correlation value that you have selected in [F11] Flow-value conversion selection will be used.

[F16] Low flow cutoff flow-rate

This is for setting the low flow cutoff flow-rate (Q_{cut}) where the instantaneous flow-rate is $0 \text{ m}^3/\text{h}$.

The settable range is defined as $0 \leq Q_{cut} \leq Q_{min}$.

The set flow-rate will be the flow-rate you selected in [F11] Flow-value conversion selection.

[F17] Atmospheric pressure of the working environment

This is used to set the atmospheric pressure value (4 digits) [kPa] of the working environment in absolute pressure. The standard factory setting has been set to 101.3 [kPa]. Leave this setting unchanged unless you are operating the meter at higher elevations, etc.

[F18] With or without pressure value averaging

Set with or without pressure value averaging to either "With averaging (10)" or "No averaging (1)." If "With averaging" is selected, the moving average value of the 10 most recently measured pressures is used for display and output.

[F00] Reset of all of accumulated values

By selecting "Clear (cLr)", the values for Accumulated flow volume (Forward flow), Accumulated flow volume (Reverse flow), and Trip accumulated flow volume are reset to zero.

[FFF] Reset to standard factory delivery settings

By selecting "Reset (SEt)", settings are reset to standard factory settings shown in Table 3-1. However, "F9 Output pulse unit" alone will be set to 1000L/P for all nominal diameters, and "F14 Fluid selection" will be set to Air.

Figure of changeover of indication of various setting modes is shown below.

Figure 4-8 Display changeover in setting mode

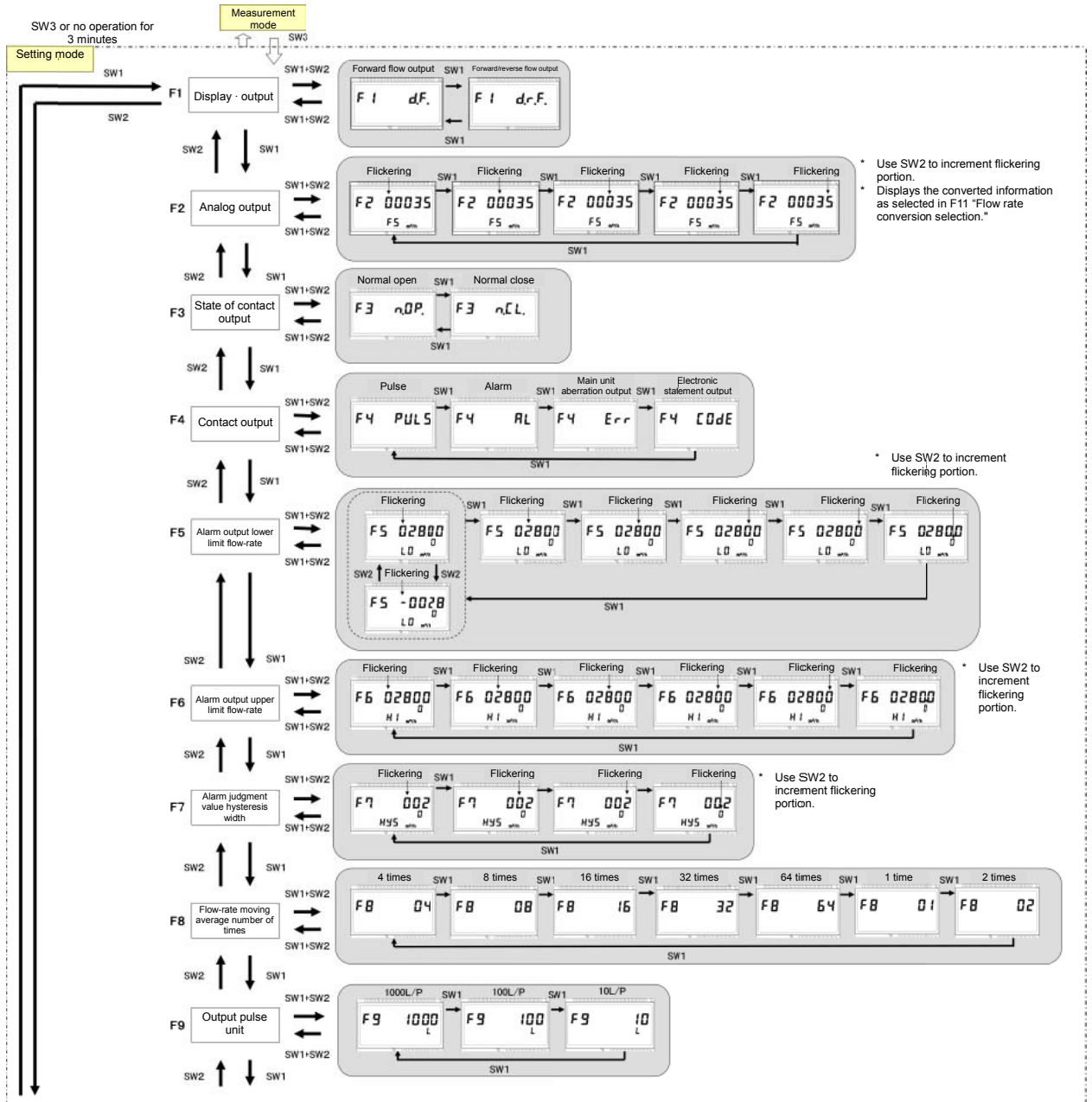

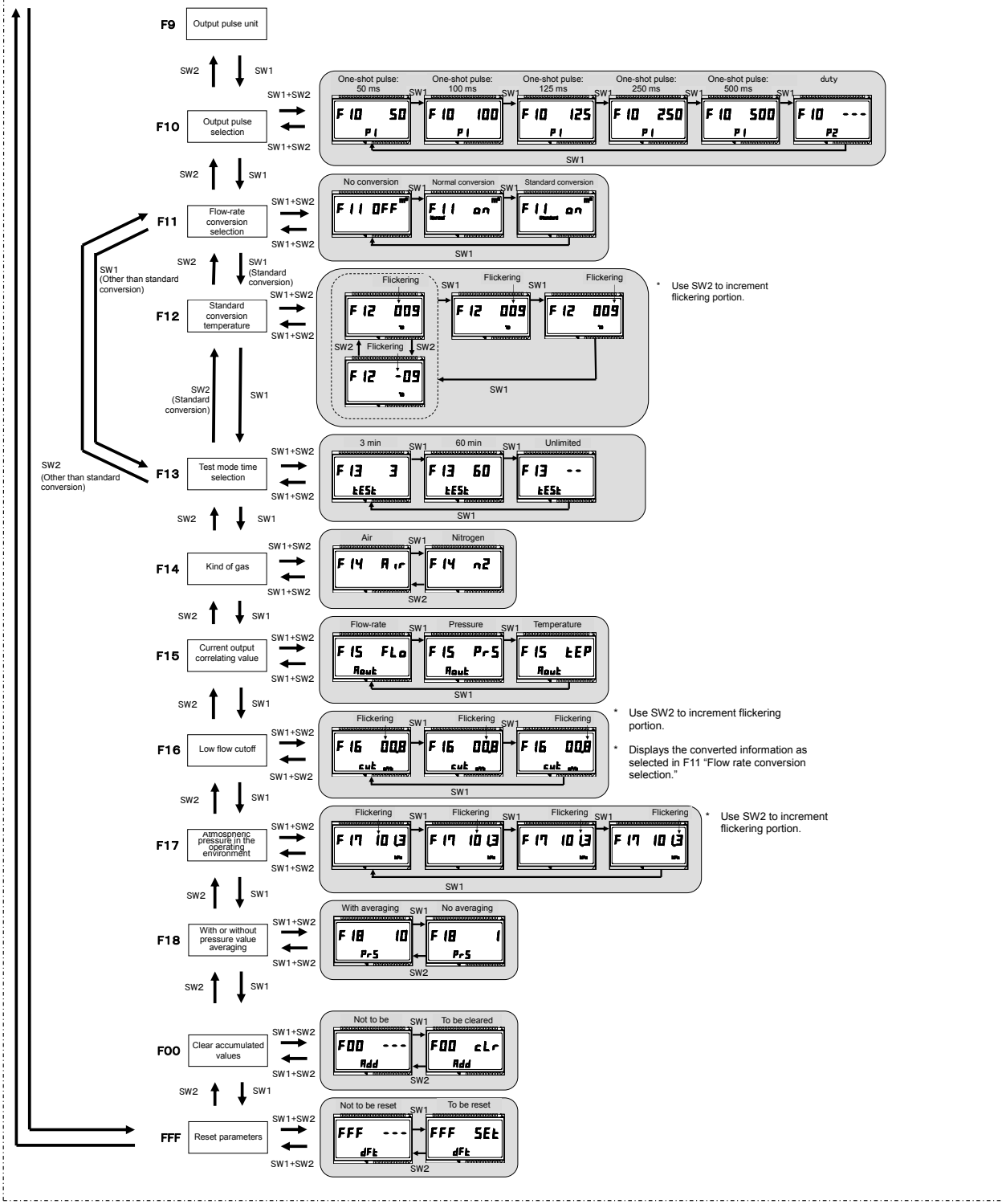

5. Wiring (External Power Supply Type)

Please be sure to conduct the wire connection using the optional cable for external connection as follows.

Figure 5-1 Wiring diagram

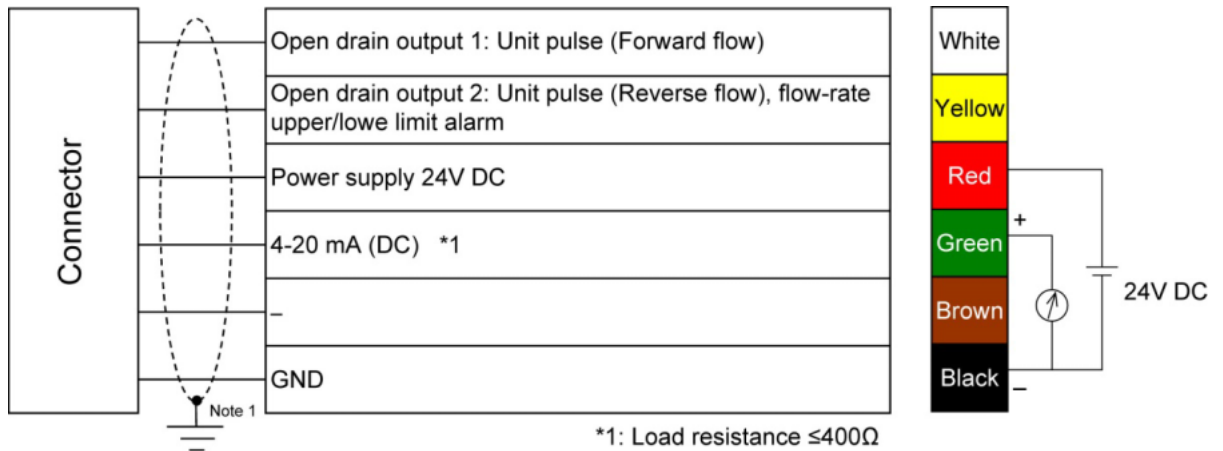

The main body and GND are electrically common.

Use an isolated power supply and a remote display as necessary.

Notes:

1. When installing the flow meter around an electric noise source, ground the braided shield of the external connection cable.
2. Cut off the brown lead wire at its root to prevent it from contacting others.
3. Do not perform the insulation resistance and withstand voltage test.

Note on open drain output setting

This meter gives you a choice of two types of outputs: duty output and one-shot output. The meter is set to duty output when it leaves the factory.

Under duty output, the ON:OFF times are 1:1. Under one-shot output you can set the ON times shorter between 50 to 500ms (Figure 5-2). Therefore, if you are using a battery-powered pulse receiving signal receiver, using a one-shot pulse output is recommended to improve battery life.

Please keep the following points in mind with regard to selecting one-shot.

- Check the waveform corruption caused by the cable (line capacity, line resistance) and the minimum input signal width of the signal receiver to choose the appropriate ON time.
- ON/OFF will reverse if you choose "Normal close."

Figure 5-2 One-shot output and duty output

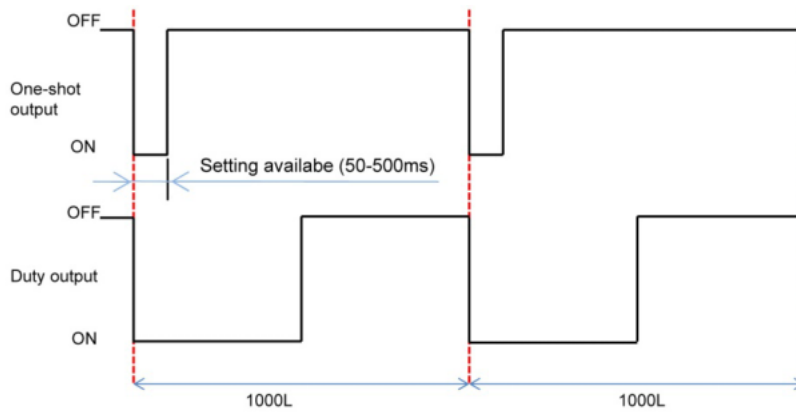

(Example with pulse constant at 1000L/P, and Normal open)

Example of pull-up resistance calculation

Check the pulse receiving signal receiver's specifications (power supply voltage Vdd [V] and ON current Ion [mA]) and select the pull-up resistance constant using equation (1).

$$R[\Omega] = [(Vdd - 0.2) / (Ion \times 10^{-3})] - 24.7 \dots \dots \text{(Equation 1)}$$

*Do not allow the current Ion to exceed the maximum load of 24 VDC and 50 mA.

Example where Vdd=24V and Ion=10mA

$$R[\Omega] = [(24 - 0.2) / (10 \times 10^{-3})] - 24.7 = 2355[\Omega] \approx 2.2[k\Omega]$$

6. Operation



Do not open or close valves abruptly. Make sure to open and close them gradually.

Opening or closing of the valve all at once may cause a failure of the flow meter if a pressure difference is occurring between the upstream side and downstream side of the valve.

When you are running the meter for the first time, check that the pilot lamp is flickering.

(A flickering pilot lamp indicates that the fluid is flowing.)

Figure 6-1 Indication at start-up

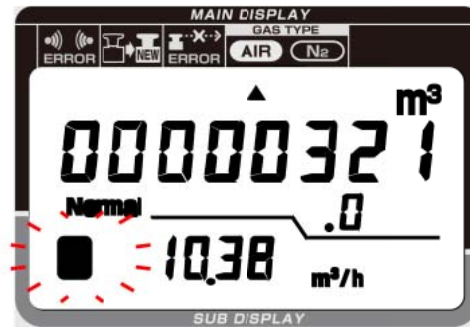

7. Alarm

7-1. Aberration in flow measurement

[State] Unable to receive ultrasonic signals.

[Display] The triangle in the upper left of the LCD **flickers**.

The instantaneous flow-rate value in the sub-display shows "0.00."

As for the accumulated flow volume value display, the accumulation process is stopped and the display shows the value immediately prior to the aberration.

[Output] Analog output: 4mA

Open drain output: Stopped

[Cause] There is a possibility that foreign materials (liquids such as oils) has become stuck to or is being retained in the measurement pipe, and is obstructing the propagation of ultrasonic.

If the alarm persists even after removing the foreign materials, please contact our branch or sales office.

Figure 7-1 Flow measurement aberration display

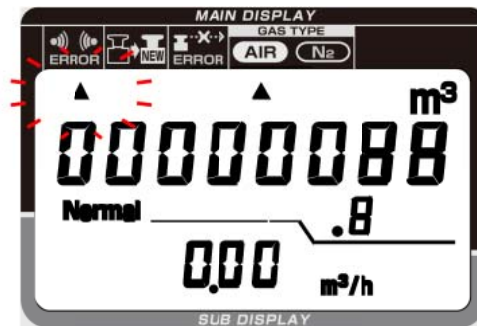

(Note) Actions when the meter is first run

Once the flow meter is installed and measurements begin, the meter may show a "flow measurement aberration display" due to the sudden change in pressure from the atmospheric pressure. This will stop once the pressure of the fluid stabilizes under working conditions. (This will return to normal.)

7-2. Aberrant pressure value

- [State] This state indicates that the pressure value has exceeded the measurement limits.
- [Display] The pressure display in the sub-display shows the aberrant value and flickers.
 The instantaneous flow-rate value in the sub-display shows "0.00" and flickers. (The display of temperature value flashes)
 As for the accumulated flow volume value in the main display, the accumulation process stops and the display shows the value immediately prior to the aberration.
- [Output] Analog output: 4mA
 Open drain output: Stopped
- [Cause] The pressure used may have exceeded the specified range.
 Other potential causes include pressure sensor failure, please contact our branch or sales office.

Figure 7-2 Pressure aberration displays

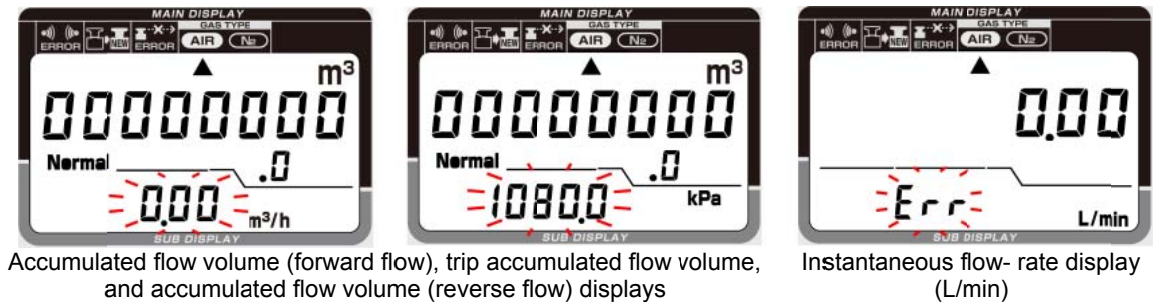

7-3. Aberrant temperature value

- [State] This state indicates that the temperature value has exceeded the measurement limits.
- [Display] The temperature display in the sub-display shows the aberrant value and flickers.
 The instantaneous flow-rate value in the sub-display shows "0.00" and flickers. (The display of pressure value flashes)
 As for the accumulated flow volume value in the main display, the accumulation process stops and the display shows the value immediately prior to the aberration.
- [Output] Analog output: 4mA
 Open drain output: Stopped
- [Cause] The aberrant temperature alarm may be triggered if setting of Fluid selection [F14] does not match the fluid being measured. If the setting is correct and you are still getting an aberrant temperature alarm, please contact our branch or sales office.

Figure 7-3 Temperature aberration displays

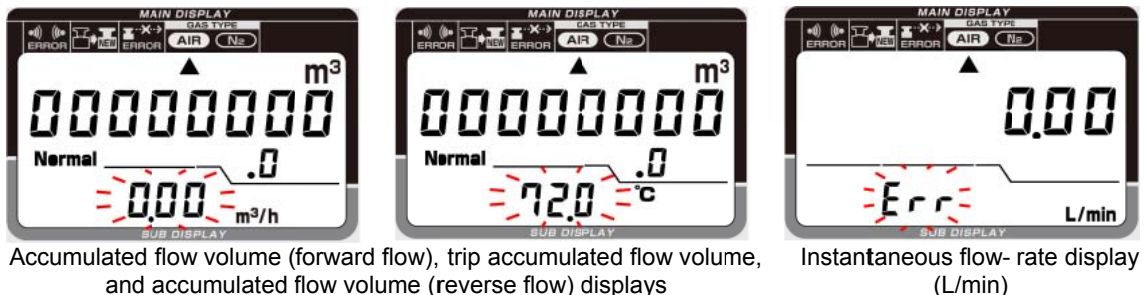

7-4. Memory aberration

[State] There is an aberration in the data in the non-volatile memory.

[1] User's area: An aberration is found in the data for settings that were changed by button operations, or in the accumulated value data upon powering the meter on.

[2] System area: An aberration is found in the data for the system (setting by users is not available).

[Display] [1] User's area: The triangle that indicates the Kind of Gas (air or nitrogen) flickers.

[2] System area: The display shows "E-2."

[Output] [1] User's area: Analog output: Normal operations
Open drain output: Normal operations

[2] System area: Analog output: 4mA
Open drain output: Stopped

[Cause] [1] In the case of a memory aberration in the user's area

- Check to see whether the set data is within the settable range. (Refer to Table 3-1.)
- If any aberrations are found with the set data, you can reset them using "[FFF] Reset to standard factory delivery settings." (*)
- If any aberrations are found with the accumulated value data, perform "[F00] Reset of all of accumulated values" and power the meter back on. (*)
*Please note that this resets your settings data or accumulated value.

[2] In the case of a memory aberration in the system area
Please contact our branch or sales office.

Figure 7-4 Memory aberration display

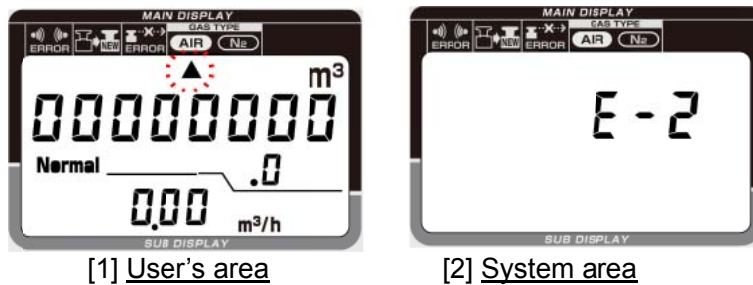

Figure 7-5 Output at aberrations

	Analog output	Open drain output
Measurement aberration	4mA	Stop
Pressure aberration	4mA	Stop
Temperature aberration	4mA	Stop
Memory aberration (User area)	Normal operations	Normal operations
Memory aberration (System area)	4mA	Stop

8. Power Interruption (External Power Supply Type)

Detection of power failure

The drop of a power source voltage to $18\pm 1.1\text{V}$ or lower is judged to be a power failure. As a result, the measurement is stopped, and the last accumulated value is stored, and the LED display is turned off.

Reset from power failure

When a power source voltage rises to $18.8\pm 1.1\text{V}$ or higher, the measurement is resumed with the total value recorded right before the power interruption, and the LED is turned on.

9. Battery Life (Built-In Battery Type)

The life of the built-in battery is 10 years. (This is the life at the environment temperature of 20°C. The battery life fluctuates depending on conditions such as the ambient temperature and output settings.)

* In the case the battery run out earlier due to reasons of high environment temperature, etc., the battery is possible to be replaced at our plant as a fare-paying service. Contact our branch or sales office nearby.

10. Troubleshooting

If you encounter any problems that cannot be resolved by taking the steps described below, please contact our branch or sales office.

	Phenomenon	Possible cause	Remedial action	Reference page
Settings	Even operating the buttons, unable to set a settings value.	Attempting to set a value that is outside the range of settable values.	Check to see that the kind of gas (air or nitrogen) indicator does not light at the time of settings mode. If this indicator lights, this is indication of attempting to set a value outside the range of settable values.	12
Installation	The measurement aberration indicator lights. 	Using a fluid other than air or nitrogen.	Check all reminders regarding specifications and installation.	12 30
		Using the meter outside its range of specifications (such as for installation conditions, pressure, temperature).		
		Foreign material is attached to the interior of the measurement pipe or ultrasonic sensors.		
Installation	It starts up but does not start accumulation immediately.	Carrying out adjustments due to pressure fluctuations.	Check to see if the partition line between the main and sub-displays is flickering. If it is, it means that the meter is undergoing adjustments for pressure fluctuations. This should typically complete in about 1 minute after which accumulation should begin.	7
	The instantaneous flow-rate shows a negative value.	The direction of the fluid flow and the flow direction of the meter are opposite of each other.	Check to see that the arrow on the surface of the flow meter is pointing in the direction of the fluid flow.	
Wiring connection	Pulses are counted incorrectly.	The pull-up resistor is too large.	Check the signal receiver's specified ON current and select an appropriate pull-up resistor.	28
		The pull-up resistor is too small.		
		The one-shot pulse ON time is equal to or smaller than the signal receiver's minimum input signal width.	Make sure to set the one-shot pulse ON time sufficiently large enough for the signal receiver's minimum input signal width.	28
	The current value of the 4-20mA output is too small.	Load resistance is 400Ω or larger	Keep the resistance below 400Ω	27
The setting value for the analog output FS flow-rate is too large.		Set an appropriate analog output FS flow-rate [F2] to suit your needs.	21	

	Phenomenon	Possible cause	Remedial action	Reference page
After start operation	Sub-display flickers (pressure and instantaneous flow-rate)	The working pressure range has been exceeded.	Check to see that the operating pressure falls between 0 to 1MPa (Gauge pressure).	30-32
		Pressure sensor failure	Contact our branch or sales office.	
	Sub-display flickers (temperature and instantaneous flow-rate)	The operating temperature range has been exceeded.	Check to see that the operating temperature falls between -20°C and 70°C.	30-32
		Gas other than air or nitrogen is being used.	Do not use gases other than air or nitrogen.	30-32
	The instantaneous flow-rate appears to be fluctuating.	The pressure fluctuates frequently.	This is normal.	
		A pressure governor is installed near the flow meter.	This is normal. Installation of the meter farther away from the pressure governor is recommended to take accurate measurements.	9
	The instantaneous flow-rate does not fall to zero even there is no flow.	The fluid is convecting in the pipe.	This is normal.	
		Test mode is on.	Check to see that the value unit on the sub-display is not flickering.	19 23
	The instantaneous flow-rate is too large.	The straight section of the pipe is not long enough.	Please make sure to properly install straight pipe sections up and downstream of the meter to suit your specific piping conditions.	8 9
		It shows the normal flow rate display.	Check to see that the correct value unit for the application is used.	12 23
	The instantaneous flow rate does not seem to change.	There is excessive flow rate.	Use the meter within the scope of its specifications.	12
	The instantaneous flow rate is too small.	The straight section of the pipe is not long enough.	Please make sure to properly install straight pipe sections up and downstream of the meter to suit your specific piping conditions.	8 9
		The display shows the Actual flow-rate.	Check to see that the correct value unit for the application is used.	12 23
	The partition line is flickering.	Carrying out adjustments due to pressure fluctuations.	If it is, it means that the meter is undergoing adjustments for pressure fluctuations. This should typically complete in about 1 minute. (The partition line may also flicker momentarily during other actions, such as when a valve is opened or closed)	
There is no "0" displayed in the upper most digit of the Accumulated flow volume.	The display is set to trip accumulated flow volume display.	This is normal. Refer to the page indicated to the right to revert to accumulated flow volume (forward flow) or accumulated flow volume (reverse flow) display.	16 18	

11. Outline Diagram

Nominal diameter: 25,32mm

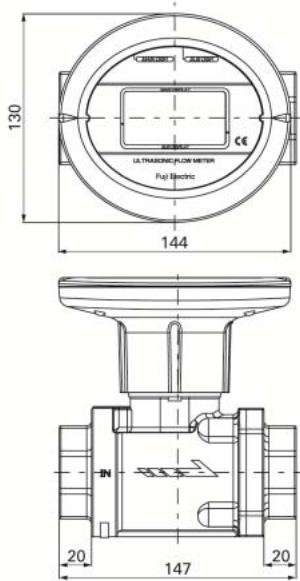

Type	Mass. (kg)
FWD025	1.7
FWD032	1.6

Nominal diameter: 40 to 80mm

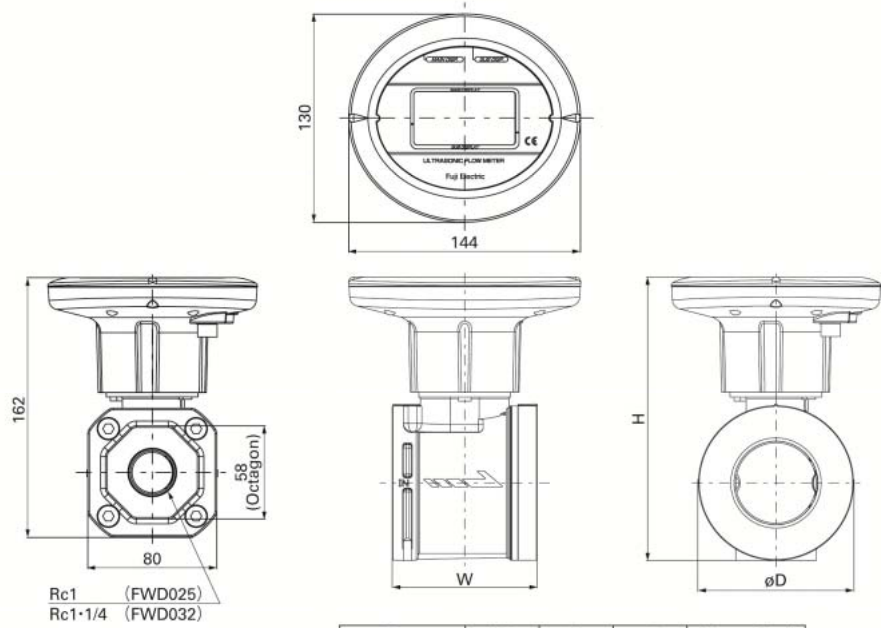

Type	W	H	øD	Mass. (kg)
FWD040	76	163	81	1.1
FWD050	90	176	96	1.3
FWD065	108	197	117	1.6
FWD080	117	220	126	1.8

Nominal diameter: 100to 200mm

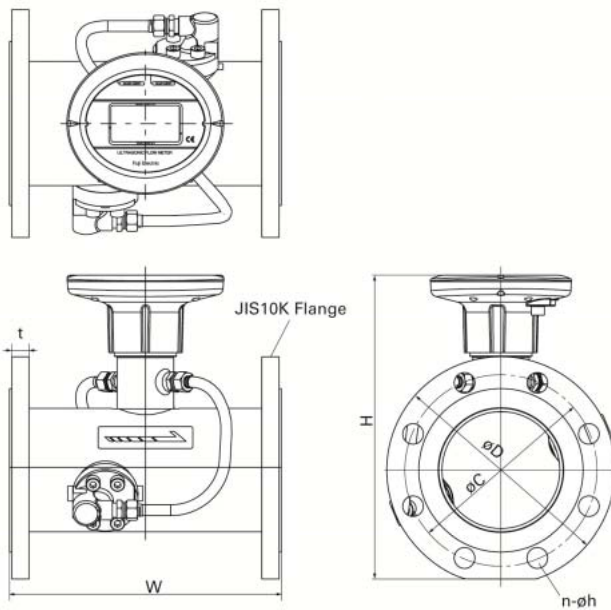

Type	W	H	øD	øC	t	n	øh	Mass. (kg)
FWD100	250	280	210	175	18	8	19	10.0
FWD150	300	341	280	240	22	8	23	18.3
FWD200	350	391	330	290	22	12	23	24.1

Warranty and Maintenance

1. Scope of application

To use this equipment, the following conditions must be met:

- the use of the equipment incurs no risk of a serious accident even if a failure or malfunction occurs on the equipment, and
- in case of product failure or malfunction, safety measures such as redundant design, prevention of malfunction, fail safe system mechanism are provided.

Be sure to use this instrument under the conditions or environment mentioned in this instruction manual. Please consult us for specifications for the following applications:

Harsh conditions for electronics, or other usages that may have large impact on lives, bodies, property, or other rights or interests

2. Operating conditions and environment

For the operating conditions and environment, refer to "For safe and proper use".

3. Precautions and prohibitions

Refer to "For safe and proper use".

4. Warranty

4.1. Period of warranty

- (1) Warranty period for this product including accessories is one year after delivery.
- (2) Warranty period for the parts repaired by our service providers is six months after the completion of repair.

4.2. Scope of warranty

- (1) If any failure or malfunction attributable to Fuji Electric occurs in the period of warranty, we shall provide the product after repairing or replacing the faulty part for free of charge at the place of purchase or delivery. The warranty does not apply to failure or malfunctions resulting from:
 - a) inappropriate conditions, environment, handling or usage that is not instructed in a catalog, instruction book or user's manual, or overuse of the product,
 - b) other devices not manufactured by Fuji Electric,
 - c) improper use, or an alteration or repair that is not performed by Fuji Electric,
 - d) damages incurred during transportation or fall after purchase,
 - e) any reason that Fuji Electric is not responsible for, including a disaster or natural disaster such as earthquake, thunder, storm and flood damage, or inevitable accidents such as abnormal voltage.
- (2) Regardless of the time period of the occurrence, Fuji Electric is not liable for the damage caused by the factors Fuji Electric is not responsible for, opportunity loss of the purchaser caused by malfunction of Fuji Electric product, passive damages, damage caused due to special situations regardless of whether it was foreseeable or not, and secondary damage, accident compensation, damage to products that were not manufactured by Fuji Electric, and compensation towards other operations.

5. Failure diagnosis

Regardless of the time period of the occurrence, if any failure occurs, the purchaser shall perform a primary failure diagnosis. However, at the purchaser's request, Fuji Electric or our service providers shall provide the diagnosis service for a fee.

6. Service life

This product, excluding some limited-life parts, is designed for a service life of 10 years under general operating conditions.

The service life may be shortened depending on operating conditions and environment. To ensure the service life, it is important to perform planned maintenance of the product.

7. Maintenance plan

Maintenance can be divided into "preventive maintenance" and "corrective maintenance". Preventive maintenance is achieved through systematic implementation of "periodic inspection".

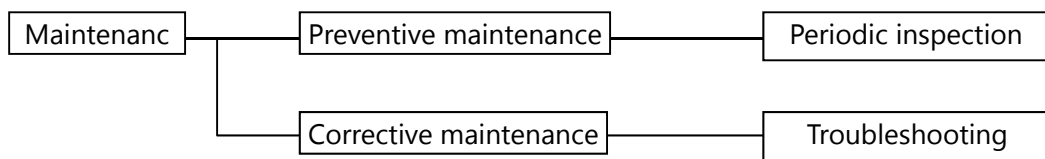

(1) Periodic inspection

Periodic inspection is to replace limited-life parts before their service lives are over, thus preventing failure. Recommended inspection interval is 6 months to 12 months. If you are using the instrument under harsh environment, we recommend you to shorten the inspection interval.

(2) Corrective maintenance

Corrective maintenance is a measure to be taken after a trouble has occurred. Refer to 10.

Troubleshooting. If the measures mentioned in this instruction manual do not solve the problem, please contact one of our sales offices or service offices.

8. Limited-life parts

This product uses some limited-life parts, such as flange packings for the wafer connection type, which may affect the service life of the product itself. Estimate the lifetime of those parts according to your operating environment, and replace them at appropriate time.

9. Spare parts and accessories

Refer to "Confirmation of package contents" for spare parts and accessories.

10. Period for repair and provision of spare parts after product discontinuation

The discontinued models (products) can be repaired for five years from the date of discontinuation. In addition, most spare parts used for repair are provided for five years from the date of discontinuation. However, some electric parts may not be obtained due to their short life cycle. In this case, repair or provision of spare parts may be difficult even in the above period.

Please contact one of our sales offices or service offices for further information.

Fuji Electric Co., Ltd.

Global Sales Section

Instrumentation & Sensors Planning Dept.

1, Fuji-machi, Hino-city, Tokyo 191-8502, Japan

<http://www.fujielectric.com>

Phone: +81-42-514-8930 Fax: +81-42-583-8275

<http://www.fujielectric.com/products/instruments/>
